

ELECTRONIC INDUSTRIES



- ★ Electronic Aids for Chemical Plants ★ New Ideas in Radio Stations
- ★ Industrial Uses of Cathode-Ray Tubes
- ★ ANEPA Eliminates War-Radio Bottlenecks

www.americanradiohistory.com

APRIL

Caldwell-Clements, Inc.



Probably Your Mallory Distributor Can Give You Help Like This—

Somewhere in the Middle West is an aircraft engine manufacturer who uses many Mallory Electronic parts in dynamometer test cells. Recently he sent us a hurry call for some Mallory phone jacks to go in the control panel of a new cell being rushed to completion. He had the right priority, too.

It was a standard jack, but as is so often the case with manufacturers immersed in war production, it was out of stock. To produce it, we would have had to start from scratch—"when, as and if!"

But we referred his request to the local Mallory distributor—who filled his needs from stock.

This is just a sample of how Mallory distributors can help. We do our level best to furnish them with adequate stocks so that essential electronic parts to fill small orders with high priorities may be handled promptly.

It will pay you to maintain a contact with your local Mallory distributor. He will give good service, furnish your purchasing department with complete information and prices; your engineering and design departments with application data; work his head off to get you those parts you need for maintenance, test equipment and pre-production models.

P. R. MALLORY & CO., Inc., INDIANAPOLIS, INDIANA

Cable Address—PELMALLO



Get acquainted with your local Mallory distributor. Or if you do not know who he is, write us and we will put him in touch with you. And, for good measure, we will send along a copy of the Mallory Catalog for ready reference.

P. R. MALLORY & CO. Inc.
MALLORY
APPROVED
PRECISION PRODUCTS



"40 CENTURIES LOOK DOWN"

Long life is the outstanding quality you require in a capacitor. And greatest guarantee of long life is the record of the past.

This record in the case of Tobe Capacitors warrants the fullest confidence . . . a record that is almost completely free of condensers that "couldn't take it".

Tobe's exacting standards mean persistent research and the constant "raising of



sights" in excellence of production.

Typical example is the Tobe Oilmite Capacitor shown below. This capacitor, impregnated and filled with mineral oil, is made with meticulous care and rated with conservatism. It is doing yeoman service as a filter condenser in secret war equipment. We welcome inquiries arising from your condenser problems.

LONG LIFE

ASSURED

CHARACTERISTICS OF TOBE OIL-MITE CAPACITORS

STANDARD CAPACITY TOLERANCE = 10% RATINGS: .05 mfd. to 2.0 mfd. • 600 V.D.C. • .05 mfd. to 1.0 mfd. • 1,000 V.D.C.
 TEST VOLTAGE . . . Twice D. C. rating GROUND TEST . . . 2,500 Volts D. C. POWER FACTOR . . . At 1,000 cycles—.002 to .005
 SHUNT RESISTANCE05 to 0.1 mfd. • 20,000 megohms • .25 to 0.5 mfd. • 12,000 megohms • 1.0 to 2.0 mfd. • 4,000 megohms

Special units can be held to 12,000 megohms per microfad depending solely on terminal construction.

A SMALL PART IN VICTORY TODAY



A BIG PART IN INDUSTRY TOMORROW



STEATITE . . .

★ Centralab's Steatite plant can furnish coil forms up to 5" diameter and pressed pieces to approximately 6 inches square. Centralab's engineering, laboratory and production experience in Ceramics extends back to 1930. In addition to Steatite, Centralab also produces other types of Ceramics.* Consult our engineering dept. on your Ceramic problems.

* Cordierite: a low thermal expansion type of ceramic.
Hy Dielectric: a ceramic suitable for capacitors and special application.

Centralab

Division of GLOBE-UNION INC., Milwaukee

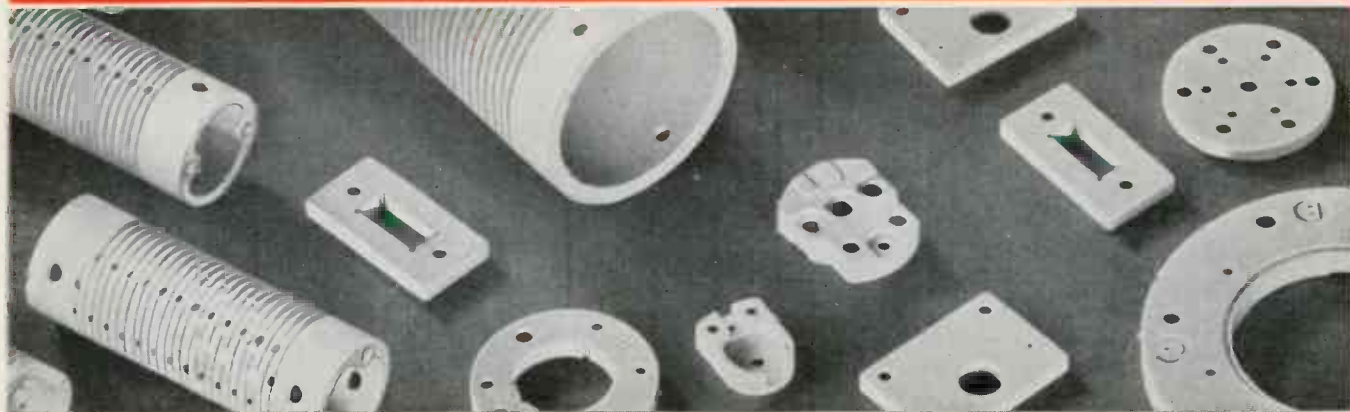



Serving the Electronic Industry since 1922...and now producing the following vital parts:

- CENTRALAB Steatite Insulators
- CENTRALAB Ceramic Trimmers
- CENTRALAB High Frequency Circuit Switches
- CENTRALAB Volume Controls
- CENTRALAB Ceramic Capacitors
- CENTRALAB Wire Wound Controls
- CENTRALAB Sound Projection Controls

Centralab

Division of GLOBE-UNION INC., Milwaukee

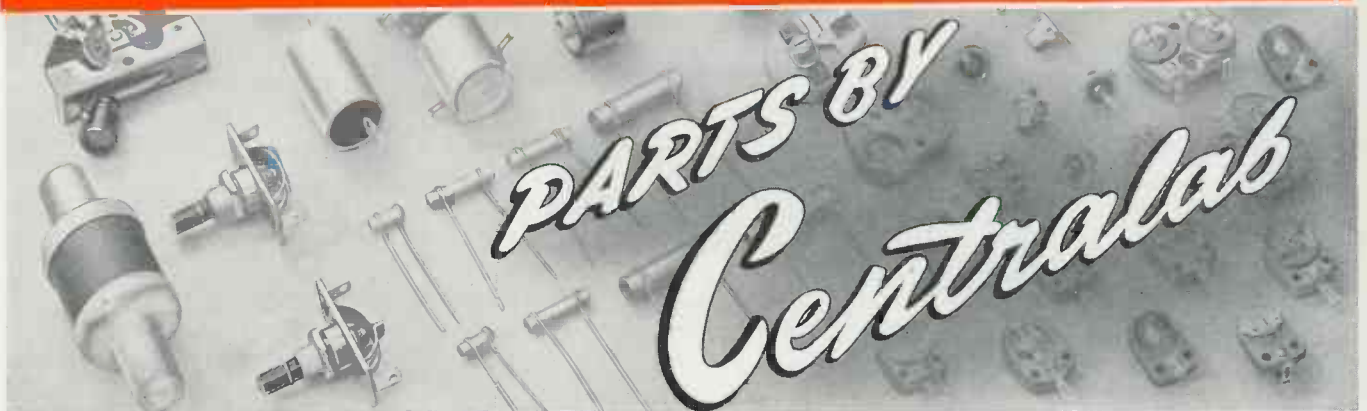

ELECTRONIC INDUSTRIES

APRIL, 1943

In this Issue

	Page
FRONT COVER—Chemical Plant at Muscle Shoals. Photo by Palmer of OWI	
CHART SUPPLEMENT—Cathode-Ray Oscillographs in Industry	
Editorial	49
How ANEPA Keeps Production Flowing.....	50
Electronics in Chemical Industries.....	52
Military Vehicle Program	56
Army-Navy Tube "Specs"	59
Factory Short Cuts	60
Shrinkage of Resistors	62
Cathode-Ray Oscillograph in Industry.....	64
(With Chart Supplement in colors)	
The Telephone Stepping Switch	76
Standards Make Instruments Interchangeable.	80
50-kw Power Amplifier	82
Decoupling Filter for Plate Isolation.....	84
Fuse Protection of Small Power Transformers.	86
When Engineer is Boss—WQXR	90
The Selenium Rectifier	94
WIBG's "Stop—Look & Listen" Studio.....	96
BC Operating Methods	98
Survey of Wide Reading	100
What's New	102
New Patents Issued	104
Washington News	109

Electronic Industries, April, 1943, Vol. II, No. 4. 35 cents a copy. Published monthly by Caldwell-Clements, Inc., 480 Lexington Avenue, New York, N. Y. M. Clements, President; Orestes H. Caldwell, Treasurer.

Subscriptions: Continental United States only, \$3 for one year; \$5 for two years. Printed in U.S.A. Acceptance under the Act of June, 1934, authorized November 10, 1942. Copyright by Caldwell-Clements, Inc., 1943.—Printed in U.S.A.

ORESTES H. CALDWELL
Editor

M. CLEMENTS
Publisher

EDITORIAL STAFF

William Moulie	Gilbert R. Sonbergh
Frank E. Butler	Josepha Zentner
Jean Mayer	Charles F. Dreyer
Ralph R. Batcher, Consulting Editor	
Roland C. Davies, Washington Editor	

BUSINESS STAFF

M. H. Newton	John A. Samborn
B. V. Splnetta	W. W. Swigert
N. McAllister	J. E. Cochran
O. H. Sutter	

R. Y. Fitzpatrick, Chicago, 201 N. Wells St.
Telephone RANdolph 9225

Editorial and Executive Offices
Telephone PLaza 3-1340
480 Lexington Avenue
NEW YORK



Not fulsome promises... but performance!

... THAT has been the keynote of

Thordarson's progress through the years.

Whenever, and wherever transformers are

discussed, the reputation for quality leader-

ship enjoyed by Thordarson is invariably

an important part of the conversation.



THORDARSON

ELECTRIC MFG. COMPANY
500 WEST HURON STREET, CHICAGO, ILL.

Transformer Specialists Since 1895



Equipment for Combat

TO see in the dark and to see at a greater distance ...to push back the clouds and fogs of ignorance has been since the beginning of time one of man's greatest aspirations.

Spurred by war, the scientific laboratories of the nation are making tremendous strides toward meeting this aspiration.

In every branch of the services our fighting men are now armed with electrical devices which enable them to pierce the black of night, the depths

of the ocean and the clouded skies. Already much of our success over our enemies on land, sea and in the air has been achieved through the use of these "electrical cats."

The peacetime possibilities of these devices which pierce the darkness are limitless.

In the very forefront in the design and manufacture of these developments stand Western Electric and its engineering organization, the Bell Telephone Laboratories.



Western Electric

ARSENAL OF COMMUNICATIONS EQUIPMENT.



QUARTZ MOTHER

THE PREPARATION OF PRECISION CRYSTALS FOR RADIO FREQUENCY CONTROL AS MADE BY CRYSTAL PRODUCTS

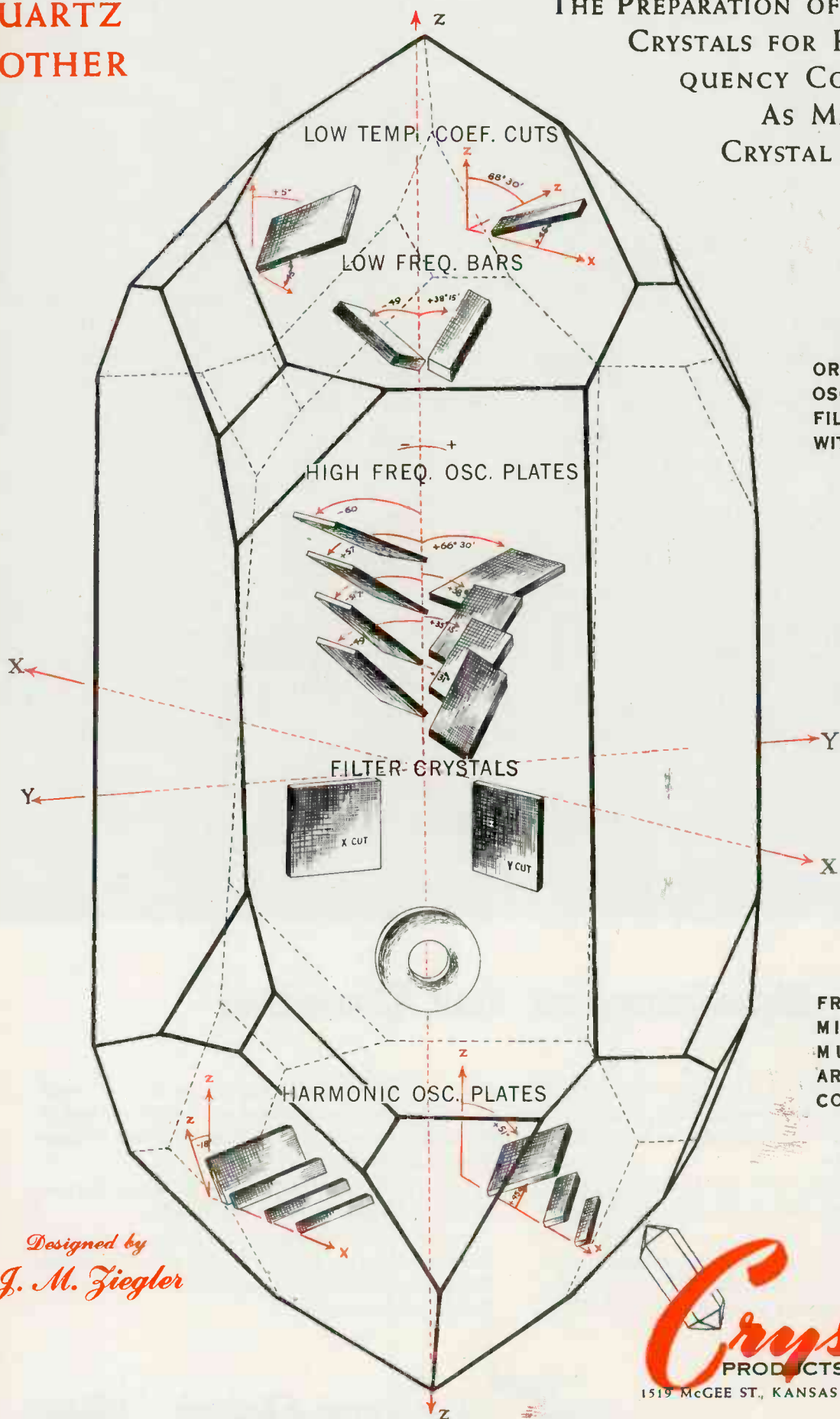

ORIENTATION OF OSCILLATOR AND FILTER CRYSTALS WITH RESPECT TO MOTHER

FREQUENCIES IN MILITARY COMMUNICATIONS ARE ACCURATELY CONTROLLED BY CRYSTALS

Designed by
J. M. Ziegler

Crystal
PRODUCTS COMPANY
1519 MCGEE ST., KANSAS CITY, MISSOURI

Producers of Approved Precision Crystals for Radio Frequency Control



Want to know what they said about special selections?

It was a fine bit of radio equipment this little band of men carried with them to the desert-outpost. But one night some of the tubes were damaged.

And the spares were not special selections and wouldn't work!

The designer and manufacturer had equipped that apparatus with special selections—tubes this little outpost didn't have . . . And that's how it happened that news of the enemy's encircling approach never reached these men . . .

The grim fact is that use of specially selected tubes can be a military liability to our forces, costing lives and perhaps even battles. For in almost every case, the Army and Navy has only standard tubes from regular stock to replace special selections. That's why the use of special selections may mean crippling the effectiveness of the radio apparatus at the very moment it's needed most. And a demand for special selection from the tube manufacturer may interfere with his production of standard, vitally important tubes—tubes that our forces

could use for replacement right in the field.

The Army, the Navy, and the War Production Board have issued directives asking us to report instances where special selections are being made, or are requested in the future. We'll cooperate, of course.

But how about you?

You can do your share by designing equipment that does not require specially selected tubes unless by proper authorization from the Service purchasing the apparatus.

And better still, you can use all the skill and experience at your command to avoid the use of specially selected tubes. Our application engineers stand ready to assist you in any way possible in solving your designing and manufacturing problems *without* special selections. Call them, consult them, work with them. Get in touch with RCA Victor Division of Radio Corporation of America, Camden, N. J.



RCA RADIO TUBES

RECEIVING TUBES • POWER TUBES • CATHODE RAY TUBES • SPECIAL PURPOSE TUBES

www.americanradiohistory.com

SIMPLE OSCILLATOR CIRCUIT

FOR ELECTRONIC
HEAT TREATMENT

★
SHOWING
LAPP PRODUCTS

ELECTRONIC

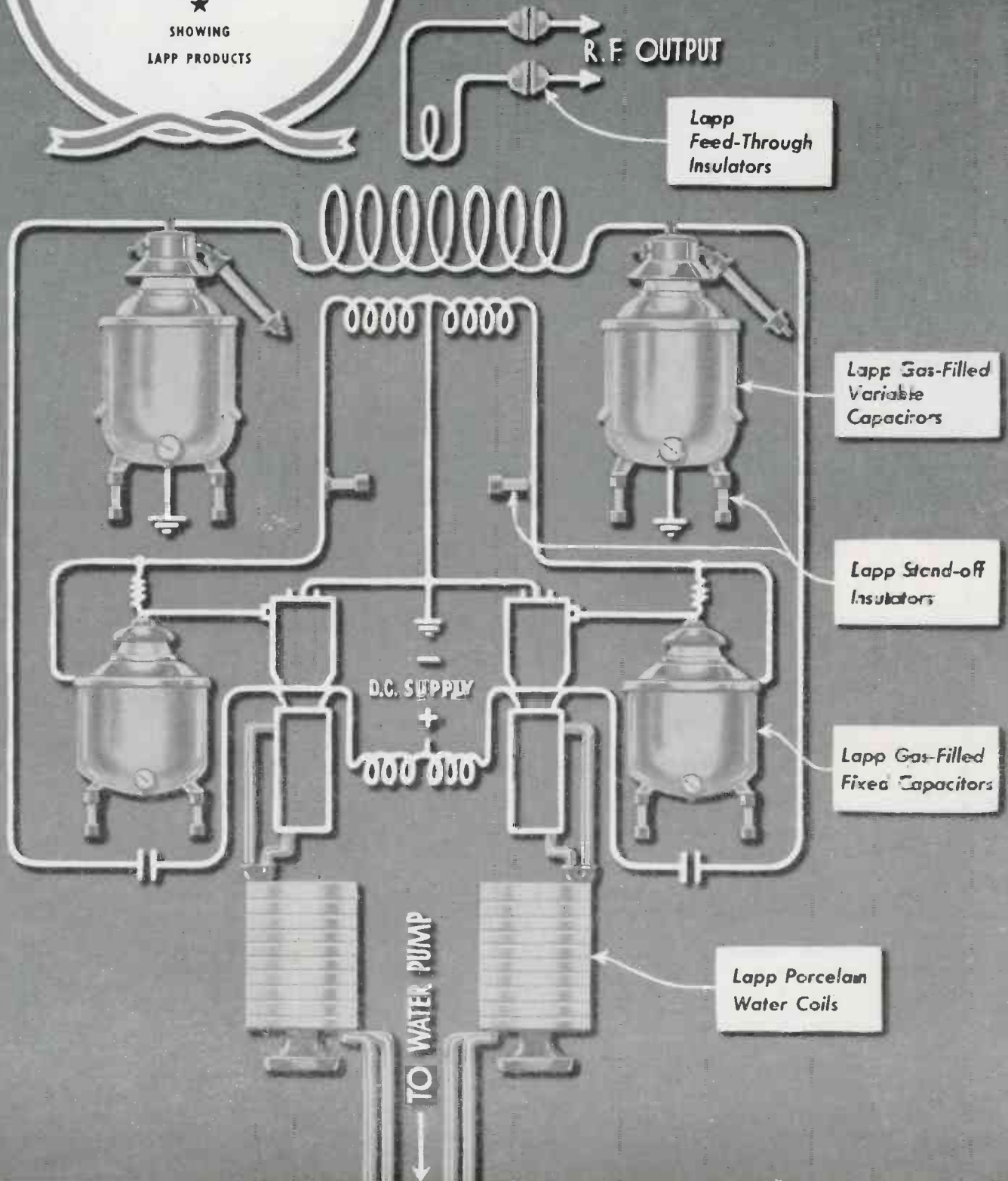

HEAT TREATING

These Lapp products reduce operating costs, improve performance, increase security

Electron-tube oscillators turn electrical "losses" into industry's gain by providing quick, efficient, localized heat. For surface hardening, for localized hardening or annealing without warping or distortion, for brazing, for bonding plywood, for certain

drying applications, for softening thermoplastics—for almost countless specialized industrial heating problems, the high-frequency oscillator offers the modern efficient method. Use of these Lapp products will save power, save time, and save trouble.

LAPP GAS-FILLED CONDENSERS

For lump capacitance in any high-power circuit, Lapp Gas-filled Condensers are the industry's best bet. In quick summary, their features include: **GAS-FILLED**—No mica is required. Use of Lapp condensers releases this critical material for more pressing needs. **PUNCTURE-PROOF**—There is no fixed dielectric to puncture; an external gap prevents internal flashover—"fail-proof" is a reasonable and honest term. **ZERO LOSS**—Loss can be measured only as zero; in comparison with solid-dielectric capacitors, a single large Lapp unit in continuous operation will effect a substantial saving on power consumption. **CONSTANT CAPACITANCE**—No warm-up period required. Lapp condensers do not heat up, and their capacitance is constant under any temperature variation. **FIXED, ADJUSTABLE AND VARIABLE STYLES**—Variable Lapp units permit precise circuit tuning as easy as tuning your home radio. Without adjusting the inductance coil you can bring your circuit to exact frequency for most efficient performance on any heating job.

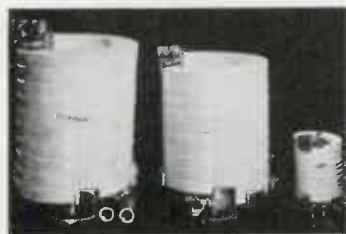

LAPP WATER COILS

The water-cooled tubes customarily used in high-power circuits can most efficiently be cooled with a system utilizing Lapp Porcelain Coils, porcelain pipe and fittings. No rubber need be used; sludging is eliminated, and with it need for periodic water changing and cleaning of the cooling system.

LAPP STAND-OFF, BOWL, ENTRANCE INSULATORS

Insulators for bus support, mounting of equipment, entrance, or any other application are available from Lapp in any wanted style and rating. Lapp is also equipped for production of many special assemblies, incorporating porcelain, steatite or special-characteristic ceramic, and associated metal parts

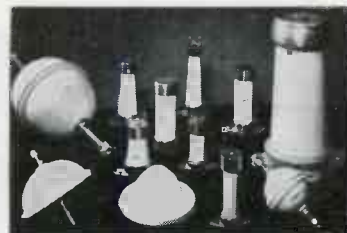

Lapp



INSULATOR CO., INC., LE ROY, N.Y.

WHERE DO ELECTRONS GO FROM HERE?

THE ERA of electronic experiment is fast giving way to the era of practical use. Already the electronic tube is doing indispensable work on the fighting fronts. At home, it is improving the tools of production, standing guard over product quality, speeding up industrial operations, and in a hundred other ways aiding in the making of more and better fighting equipment.

But between the electron tube and the "work to be done" there is a gap to be bridged. The tiny electronic currents must be captured, controlled, and put to useful work. Here is where Automatic Electric relays and stepping switches do their part—completing the link between tube and tool. That's why they're being called the "muscles for the miracle of electronics."

Today, Automatic Electric field engineers are working with the makers of electronic devices in many fields—offering time-saving suggestions for the selection of the right apparatus for each job, and the benefit of the technique which comes from fifty years of experience in remote control applications.

If you have a control problem—electronic or electrical—be sure to get the Automatic Electric catalog of control apparatus. Then, if you would like competent help in selecting the exact combination for your needs, call in our field engineer. His long experience will save you time and money.

AMERICAN AUTOMATIC ELECTRIC SALES COMPANY
1033 West Van Buren Street, Chicago, Ill.

Relays
AND OTHER CONTROL DEVICES
by **AUTOMATIC ELECTRIC**

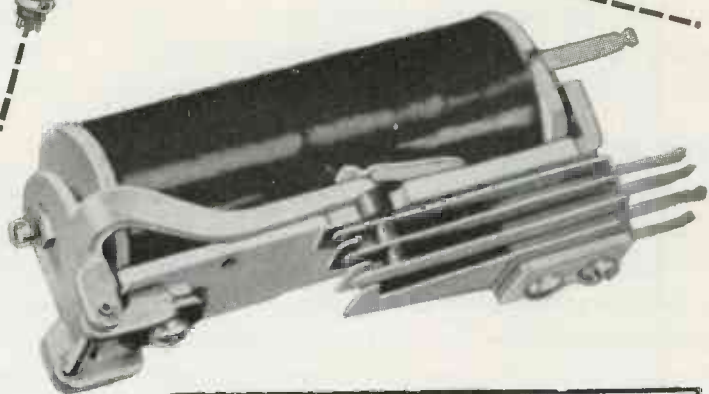

Automatic Electric control devices are working with electronic tubes in these typical applications:

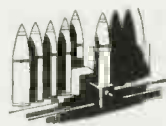

Quality control—automatic inspection and sorting operations



Detecting and indicating—checking operations and revealing unstandard conditions



Automatic or directed selection of mechanical or electrical operations



Selection and switching of signaling and communication channels



Counting and totalizing of mechanical or electrical operations



Time, temperature and sequence control of industrial processes.

The Automatic Electric catalog of control apparatus is the most complete reference book on the subject ever published. Write for your copy.



MUSCLES  FOR THE MIRACLES OF ELECTRONICS

G.E. ANNOUNCES

A NEW VOLTAGE STABILIZER

that is insensitive to load power factor



PROVIDES CONSTANT OUTPUT VOLTAGE

Here are a few of its many applications:

- 1 Radio transmitters
- 2 Radio testing equipment
- 3 Electronic-tube apparatus
- 4 Motion-picture sound equipment
- 5 Motion-picture projectors
- 6 Telephone apparatus
- 7 X-ray machines
- 8 Photo-cell equipment
- 9 Precision photographic equipment
- 10 Photometers
- 11 Color comparators
- 12 Calibration of meters, instruments, relays
- 13 Laboratory precision processes and testing equipment

**NO MOVING PARTS • NO ADJUSTMENTS
NO MAINTENANCE**

Engineers, note these performance features!

WIDE LIMITS FOR INPUT VOLTAGE—95 to 130 volts—ample for all ordinary voltage conditions.

CONSTANT OUTPUT VOLTAGE—For any fixed load, $\pm 1/2$ per cent. For any load that varies between full load and half load, and power factor between unity and 0.8 lagging, the output voltage will not vary more than $\pm 1 1/2$ per cent. For simultaneous variations in input voltage, load, and load power factor—with load between no load and full load, and load power factor between unity and 0.8 lagging—the output voltage will not vary more than $\pm 2 1/2$ per cent.

QUICK RESPONSE—Stabilizing action takes place in less than three cycles.

LEADING INPUT POWER FACTOR—Approximately 20 per cent at no load, and 70 per cent at full load.

CURRENT-LIMITING FEATURE—On short circuit the output is limited to approximately 130 per cent of full load—especially valuable for electronic-tube apparatus during the filament warming-up period.

LOW HARMONIC CONTENT—Only about 6 per cent at or near full load, unity power factor. Only slight variations in harmonic content result from variations in input voltage.

COMPLETELY SELF-PROTECTING—Will operate continuously throughout the range from open circuit to short circuit without damage.

HERE is a voltage stabilizer that digests variations in load or power factor, or both, and continues *unaffected* in its smooth, reliable regulation of voltage. Variations in load from no load to full load bother it not a whit. Changes in power factor from unity to 0.8 lagging leave it indifferent.

Electronic-device manufacturers who build it into their equipment, or offer it as an accessory, will find that it means better performance and greater salability of their products. Present users of electronic devices will likewise find that it can improve the perform-

ance and reliability of their equipment. This stabilizer is ideal for precision control of many laboratory processes.

If your problem is one of providing constant voltage for the operation of diversified electric equipment—all or much of which has fluctuating loads and power factor—solve it by installing G-E stabilizers, the only voltage stabilizer on the market that is insensitive to load power factor. Available ratings from 50 va to 5000 va. Ask our local office for Bulletin GEA-3634—the complete story. General Electric Co., Schenectady, New York.

GENERAL ELECTRIC



www.americanradiohistory.com



The Army-Navy "E", for Excellence in the manufacture of war equipment, now flies over six G-E plants employing 100,000 men and women.

SHADOW AND SUBSTANCE

In the highly specialized field of electronics, the question "Who made the tubes?" will always be a matter of vital importance. Power tubes bearing the name "United" are products of original pioneers in the miracle known today as electronics. Step by step these seasoned engineers helped evolve the principles and advance the science of fabricating transmitting tubes which hold a superb record of performance. The early pioneers at United are *still actively pioneering!* The wealth of experience which they have been privileged to accumulate under the demands of war will be available to you when "United" electronic tubes are available again on a peace-time scale for radio and industrial applications.

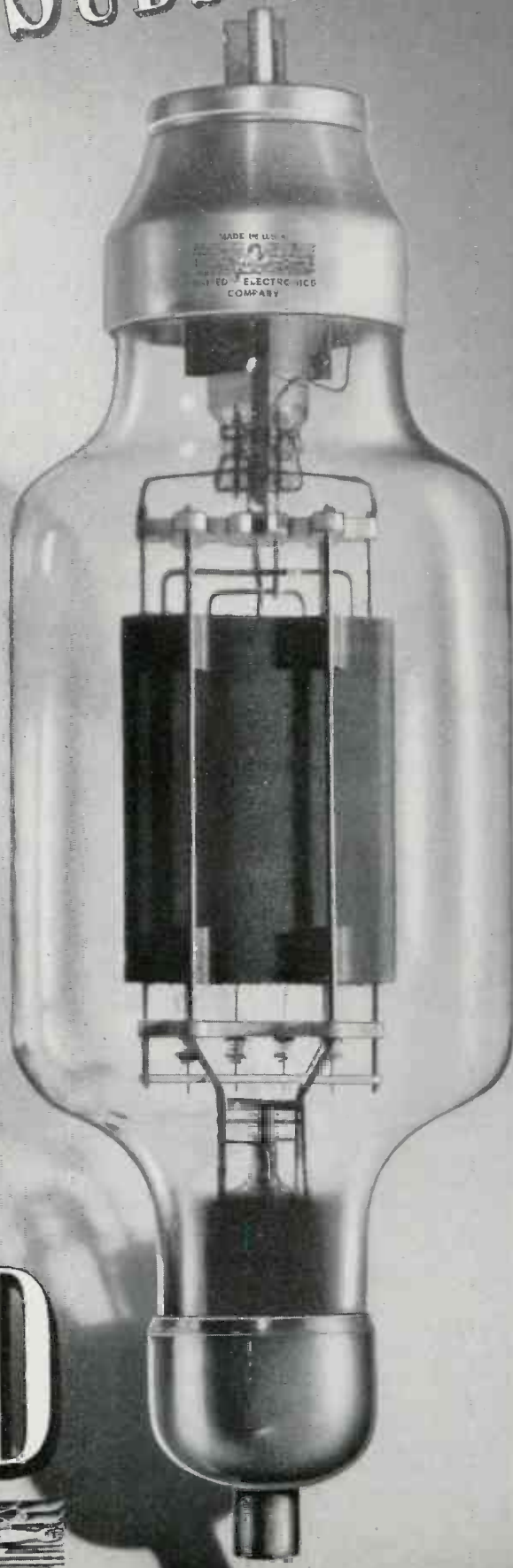

UNITED

ELECTRONICS COMPANY
NEWARK NEW JERSEY



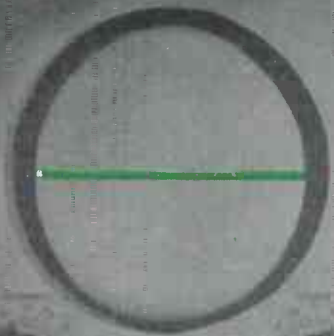

+

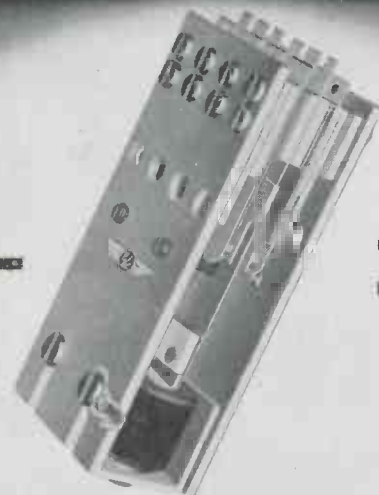

=

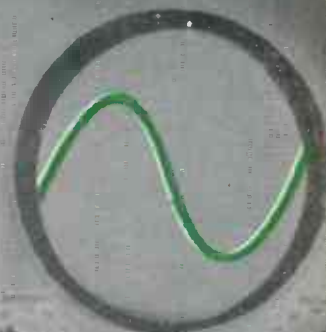

THE VIBRATOR IS THE HEART
OF THE POWER SUPPLY

FROM 6-VOLT DC TO SINE-WAVE 110-VOLT AC!

E·L is the Only Vibrator Converter

That Can Produce This Result

All electrical engineers know that the Sine-Wave current form is more efficient than any other, particularly in the operation of motors and of test equipment.

—But, not all electrical engineers know that it is possible, with an Electronic Vibrator Power Supply, to convert DC current of almost any voltage to AC current of desired voltage and Sine-Wave form.

This is but one of an infinite number of advances which have been made by Electronic Laboratories through intensive development of the principle and technique of *vibrator type* power supplies, coupled with probably the world's most extensive research on power supply circuits. For instance: capacities up to 1,000 Watts—tremendous savings in weight—new output efficiency—close voltage regulation, to name a few.

Wherever electric current must be changed, in voltage, frequency or type—for war or peace—*E·L* Vibrator Converters will do the job more efficiently—more economically—and last longer. Electronic's engineers will be glad to work with you in meeting your current conversion needs.

Only *E·L* VIBRATOR POWER SUPPLIES Offer All These Advantages:

1. CONVERSION—DC to AC; DC to DC; AC to DC; AC to AC.
2. CAPACITIES—Up to 1,000 Watts.
3. VARIABLE FREQUENCIES—A power supply may be designed to furnish any frequency from 20 to 280 cycles, or a controlled variable output within a 5% range of the output frequency.
4. MULTIPLE INPUTS—For example, one *E·L* Power Supply, in quantity production today, operates from 6, 12, 24, 110 volts DC or 110 volts AC, and 220 volts AC, with a single stable output of 6 volts DC.
5. MULTIPLE OUTPUTS—Any number of output voltages may be secured from one power supply to suit individual needs.
6. WAVE FORMS—A vibrator power supply can be designed to provide any wave form needed for the equipment to be operated.
7. FLEXIBLE IN SHAPE, SIZE AND WEIGHT—The component parts of a vibrator power supply lend themselves to a variety of assembly arrangements which makes them most flexible in meeting space and weight limitations.
8. HIGHEST EFFICIENCY—*E·L* Vibrator Power Supplies provide the highest degree of efficiency available in any type power supply.
9. COMPLETELY RELIABLE—Use on aircraft, tanks, PT boats, "Walkie-Talkies," jeeps, peeps and other military equipment, under toughest operating conditions has demonstrated that *E·L* units have what it takes!
10. MINIMUM MAINTENANCE—There are no brushes, armatures or bearings requiring lubrication or replacement because of wear. The entire unit may be sealed against dust or moisture.

Electronic
LABORATORIES, INC.

E·L ELECTRICAL PRODUCTS—Vibrator Power Supplies for Communications . . . Lighting . . . Electric Motor Operation . . . Electronic Equipment on Land, Sea, or in the air.

INDIANAPOLIS





Neither were planned for war

We're not raising new generations to die on battlefields; we're not designing implements for future wars. We Americans are a peace and freedom-loving lot, with an economy that is geared to the home . . . washing machines, automobiles, radio . . .

But we first must finish an unpleasant job of blasting the daylights out of those who deliberately attacked our way of life. For that purpose, we've given our men. And our men are getting the very best tools for that piece of grim business.

We thank heaven that change, progress and mass production are an integral part of a system that enabled us to redesign our products for military applications. True, our new designs were speeded by war necessity—but we like to think of these latest Electro-Voice microphones as no different from the others in our evolutionary scale.

For, as eagerly as any soldier on a fighting front, we retain a vision of returning again to our natural mode of living. We plan to build better microphones for civilian communication . . . for music . . . for laughter . . .



Electro-Voice MICROPHONES

ELECTRO-VOICE MANUFACTURING CO., INC.

1239 SOUTH BEND AVENUE, SOUTH BEND, INDIANA

**Technically-informed supplier
of electronic materials . . .**

★ ★ ★ ★
★ BUY
★ U.S. WAR
★ BONDS
★ ★ ★ ★



Your local

RCA TUBE and EQUIPMENT DISTRIBUTOR

'ROUND-THE-CORNER SERVICE!

Following are but a few of the electronic items regularly handled by your local RCA Tube and Equipment Distributor:

- RCA, CUNNINGHAM, and RCA VICTOR RADIO TUBES
- RCA SPECIAL PURPOSE TUBES
- RCA POWER TUBES, PHOTOTUBES, CATHODE RAY TUBES, etc.
- RCA ELECTRONIC TEST EQUIPMENT

. . . also condensers, resistors, rheostats, controls, potentiometers, coils, transformers, wire, and numerous other radio and electronic components produced by many manufacturers.

Making war equipment that necessitates frequent calls for tubes and other electronic components?

Then get acquainted with your *local* RCA Tube and Equipment Distributor today!

He may have just what you need in stock for immediate delivery upon receipt of a suitable priority. If he doesn't, he is well equipped to get it for you as fast as circumstances permit—and to render an intelligent, personalized expediting service all along the line.

Equally important is his technical knowledge. He has been dealing with things electronic since the "knee pants" days of radio. He knows what to use and how to use it. You'll find his technical advice and recommendations a big help.

There are over 300 RCA Tube and Equipment Distributors throughout the country. Write or wire for a list of those nearest you.

RADIO CORPORATION OF AMERICA
RCA Victor Division, Camden, N. J.



AN ADVERTISEMENT OF THE RCA TUBE AND EQUIPMENT DIVISION IN THE INTEREST OF GREATER SERVICE AND EFFICIENCY IN PRIORITY-COVERED WAR MATERIALS BUYING

Electronics

The Pinhole Detector automatically spots, classifies and marks minute holes smaller than 1/64 of an inch in tinplate racing through a shearing line at 1,000 ft. per minute. This application shows one of the many ways the photo-electric cell is being applied to heavy industrial processes—to save time and improve products.

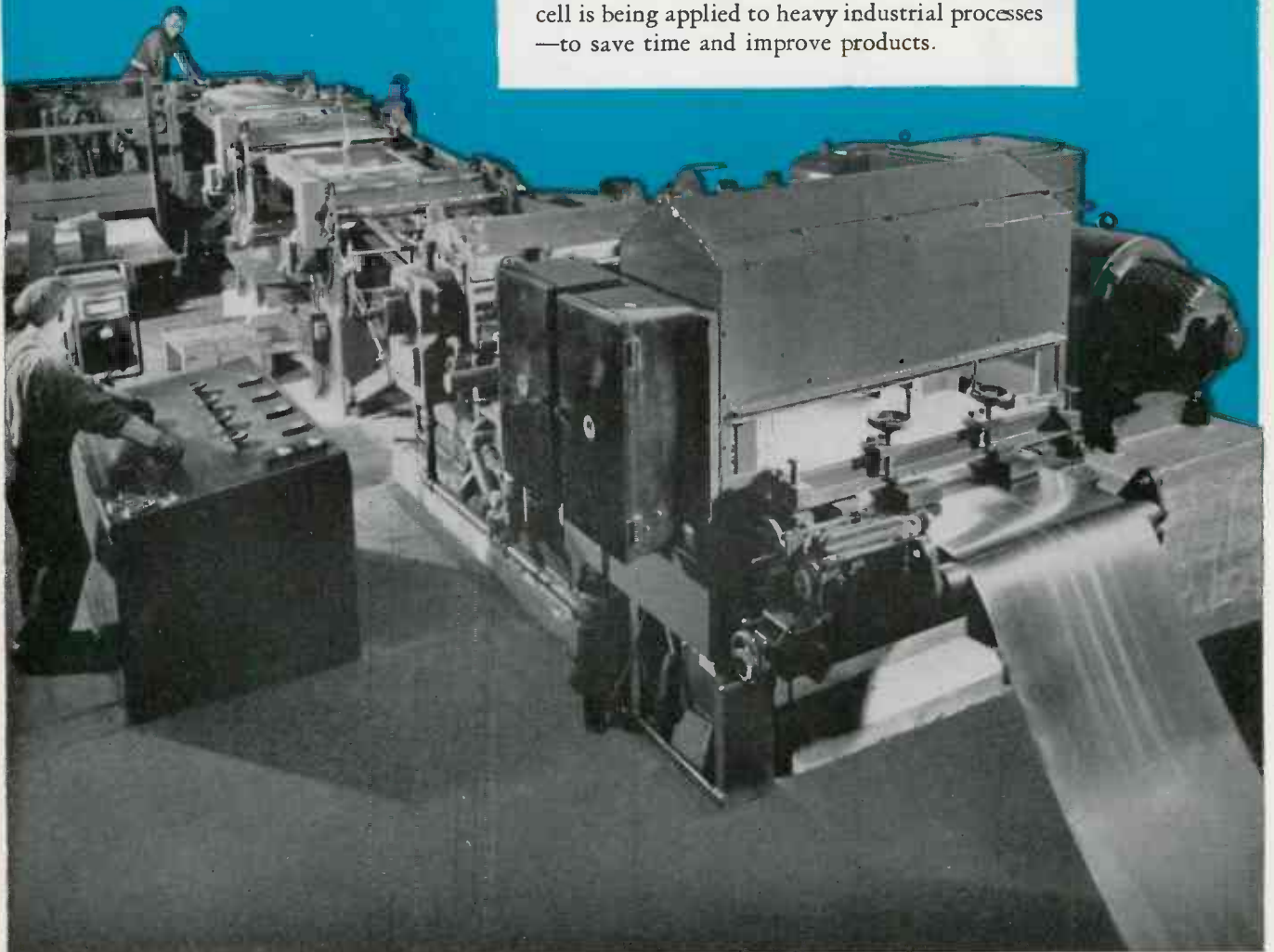

at Work

Exciting as the future of Electronics may be, it is far more than a "science of tomorrow." Electronic devices are at work *today* in practically every war industry—speeding production, improving products, cutting costs. Here are typical examples of Westinghouse "Electronics at Work."

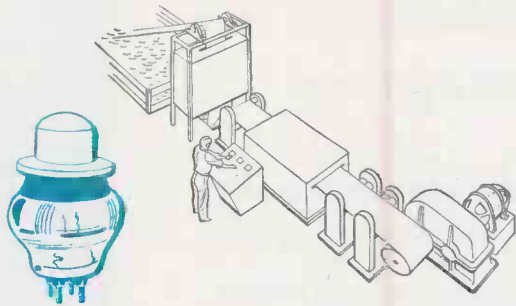

Saving Tons of Tin—Through the use of high-frequency electronic tubes, induction heating at 200,000 cycles per second is used to "flow" tin electrolytically deposited on steel strip. By this means, a coating of tin 1/30,000,000 of an inch thick becomes smooth and corrosion-resistant.

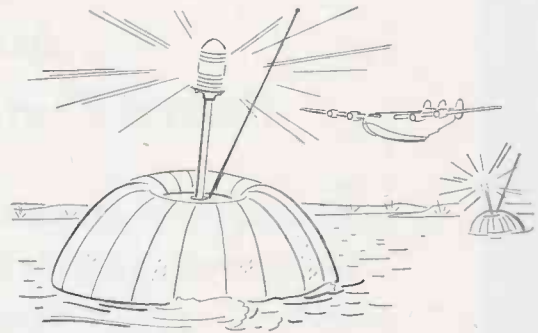

Safe Night Landings for giant clipper planes are made possible by seadrome lights controlled by electronics. An entire landing lane can be turned on by shore radio to meet the arriving plane's requirements and guide it to a safe, sure landing, even in pitch darkness.

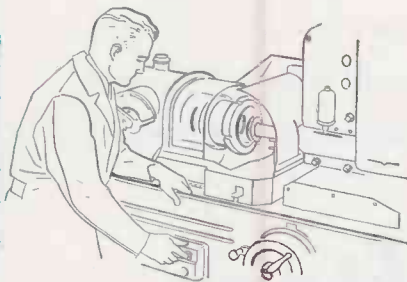

Removing Oil Mist created by gear-grinding and thread-cutting operations is a highly important application of PRECIPITRON—the Westinghouse electric air cleaner. Electronic tubes in the Precipitron's power pack create a 12,000-volt electrostatic field, which draws oil and dust particles irresistibly to charged collector plates.

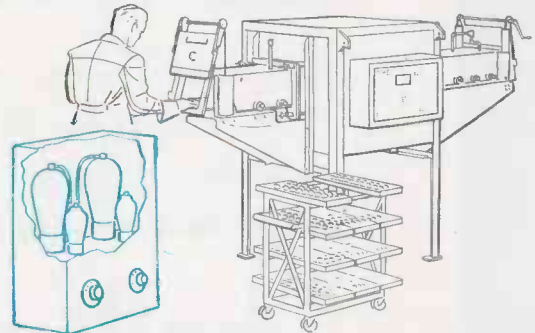

Heat-treating at 2000° C. can now be controlled more precisely than ever before possible. Thyatron tubes, actuated by the temperature recorder, react to minute variations in temperature. They control a saturable reactor, by which current entering the furnace is increased or decreased to maintain a nearly constant temperature.

J-91013-A

For further information on practical applications of Westinghouse Electronic devices, write or phone your nearest Westinghouse office, Westinghouse Electric & Manufacturing Company, East Pittsburgh, Pa.



Westinghouse
PLANTS IN 25 CITIES... OFFICES EVERYWHERE

ELECTRONICS



Improved in War!

... for Better Peace-Time Reception

The rigors of modern warfare are the world's finest proving grounds for communications equipment . . . constant usage and unusual operating conditions in every climate are a severe test of the communications receiver. Hallicrafters equipment is proving its high quality performance capabilities with our armed forces.

Hallicrafters communications receiver Model SX-28 (illustrated) 15 tubes, 6 bands, delivers outstanding reception . . . your peace-time model will be worth waiting for.

hallicrafters

CHICAGO, U. S. A.

The World's Largest Exclusive
Manufacturer of Short Wave Radio
Communications Equipment





INSULATED WITH MYKROY

U. S. Army Photograph

THE miracle of MYKROY is today performing feats in insulation, unbelievable a few years ago. In stratosphere altitudes, where other insulating materials fail*—MYKROY persistently resists loss of energy. Where other ceramic insulators suffer from shock—MYKROY proves indestructible. Where other materials add surplus weight—MYKROY offers lightness.

This technically advanced glass bound mica insulating material—prepared from an exclusive formula—will pass or dissipate negligible electrical energy through the entire range of frequencies.

STYMIED IN YOUR PRODUCTION? Let us help you break this bottleneck with MYKROY. Over 4000% expansion in the last two years assures ample quantities and can be supplied for war and essential production requirements. For further information, please communicate with us.

*MYKROY has stood the shocks of battle with distinguished success.

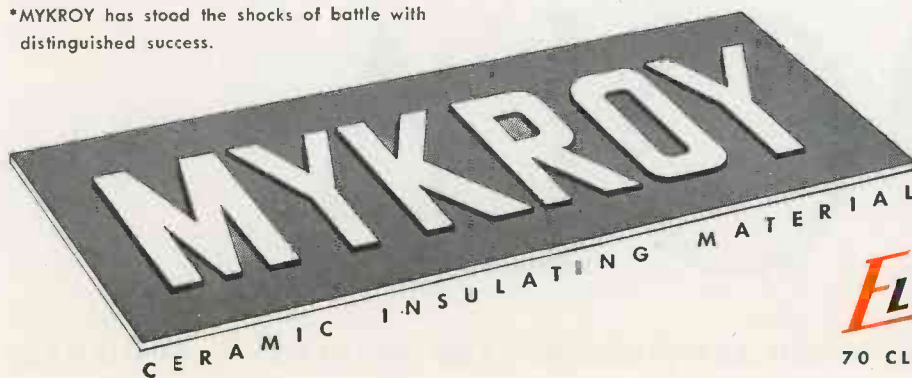

MYKROY is widely used for military, naval, electronic industrial and scientific applications of which the following are typical.

- | | |
|--|-------------------------|
| Stand-off Insulators | Variable condensers |
| Tube and Crystal Sockets | Mounting strips |
| Structural supports for radio circuits | |
| Plug-in bases | Antenna reel insulators |
| Insulated couplings | Lead-in insulators |
| Motor generator brush holders | |
| Padding condenser supports | |
| High voltage arc shields | Oscillator circuits |
| Fixed condensers | Impregnated resistors |
| Radio frequency coil forms | |
| Radio frequency panel assemblies | |
| Radio frequency switches | Relay bases and arms |

●
 SUPPLIED IN SHEETS . . .
 MACHINED WITH PRECISION
 MOULDED TO SPECIFICATION
 . . . MADE EXCLUSIVELY BY

ELECTRONIC MECHANICS
 INC.

70 CLIFTON BOULEVARD, CLIFTON, N. J.



“Cruiser and transport ahead . . . **LET’S TAKE ’EM!**”

Messages like these “must go through,” and to make certain they do, the communication systems in our Army and Navy aircraft are as sensitive, as rugged, and as trouble-defying as advanced design and precision manufacturing methods can make them.

Producing transformers, headsets and other communications equipment for the Army and Navy Air Forces is ROLA’s present responsibility to the war program. To keep abreast . . . and ahead . . . of demands, new machines have been designed, new methods devised, new tests and inspections applied. Facilities have been

expanded, and production vastly increased.

All this is important to peacetime users of ROLA equipment, for it is only logical to believe that the research and the skill and the equipment inspired by wartime necessity will find important application in the Electronic World of Tomorrow.

The “know how,” gained through twenty years of leadership in the radio field, has enabled ROLA to meet . . . and exceed . . . every war demand made upon it, both as prime and as subcontractor. We have facilities available for additional contracts. If you are interested, we suggest you write us . . . or ask our representative to call. THE ROLA COMPANY, Inc., 2530 Superior Avenue, Cleveland, Ohio.

★ ROLA ★

MAKERS OF THE FINEST IN SOUND REPRODUCING AND ELECTRONIC EQUIPMENT

FOR SALE—ELECTRONIC PRODUCTION AIDS



**CONSERVE
PAINT
ELECTRONICALLY**

Have you automatic paint sprays for conveyor lines? Install G-E photoelectric relays to control paint sprayers. They save paint by using it only when object is in exactly the right spot or area; make every unit the same. Bulletin GEA-1755C for details.

HOW BLUE IS SCARLET?

Paint, pigment, dye manufacturers need to know how to match colors perfectly. G-E electronic recording color analyzer does the job. Gives you a complete, accurate, permanent "curve of color" on any of two million shades and tones in two minutes. Helps control manufacturing processes; aids in chemical analysis. Used as basis for ASA war color standard. Get more information in Bulletin GEA-3680.

To Measure Actual Strain in Structural Parts

Now you can check calculated stresses with actual measurements. Improve design, save materials. One railroad saved literally millions of dollars in new construction by reinforcing its bridges to carry increased loads. G-E electronic equipment and electric strain gages enabled them to make this saving. A real electronic tool for the structural engineer. Bring us your problem—bridge, building, airplane, crane, locomotive, or what have you. Ask for Bulletins GEA-3673 and GEA-2543.

HOW TO SAVE ON A-C RESISTANCE-WELDER MAINTENANCE

Replace mechanical contactors with G-E electronic contactors. No moving parts! No tips to dress. No noise. No open arc. No time-lag. Faster production. Electrodes last longer. Timing more exact. Use long-life G-E ignitron tubes. Installations usually pay for themselves in short time. One user, with 156 tubes installed, reports only three tube failures in two years! Act now! Bulletin GEA-3058B gives more information.



DO YOUR WORKMEN SQUINT

WHEN DAYLIGHT DIMS? G-E electronic light control turns on factory lights whenever daylight level is too low—turns them off when daylight is sufficient. Saves eyes, helps maintain production, saves power. Many other uses. Low cost. Bulletin GEA-2679B gives installation information, diagrams.

Delicate Timing!

Standard G-E electronic timers go down to 0.045 second and up to two minutes; five ranges to choose from. Special ranges on request. Consistent. Stepless time range controlled by knob on front. Only one moving part. Only one tube. Used to time resistance welders, induction furnaces, conveyors, laboratory operations, and many other applications. Thousands in use. 110 or 220 volts, a-c. Price, \$28 and up. Bulletin GEA-2902B.

MACHINE-TOOL USERS!

You can change machine-tool speed instantly with new G-E Thy-mo-trol. This electronic motor control gives you complete motor speed range on a single dial—small as a radio volume control. Thy-mo-trol starts, stops, accelerates, controls speed, and protects the motor. Operates d-c motor on a-c power. Compact. No moving parts. No vibration. Saves operator's time. Users report increased machine output and longer cutter life. Get free Bulletin GED-972A.

IS YOUR METAL-STRIP PRODUCTION LEAKING OUT THRU PINHOLES?

Are pinholes in your rolled-sheet stock causing rejects, complaints—slowing up war work? Catch them, before they get into the stock pile, with G-E electronic pinhole detector. Finds and marks pinholes only 1/100-inch in diameter at 750 to 1000 feet per minute. Operates shear to cut out faulty areas. A real wartime production aid. Ask your G-E representative for the whole story. Get Bulletin GEA-3530.



You lose truck and operator time whenever drivers stop to open doors manually. G-E electronic control opens and closes motor-operated doors automatically—without stopping trucks.

One manufacturer saves \$30 a day in time and heat.

Don't waste valuable trucking time by delays in opening doors manually. Get more hours per day out of the trucks you have—with G-E photoelectric control. Bulletin GEA-1755C.

General Electric, Sec. H676-100
Schenectady, N. Y.

I want to know more about speeding production electronically. Please send me the bulletins checked;

- GEA-1755C—Photoelectric relays
- GEA-3680—Spectrophotometer
- GEA-3673 } G-E electric gages
- GEA-2543 }
- GEA-3058B—Electronic contactors for a-c resistance welders
- GEA-2679B—Automatic light control
- GEA-2902B—Electronic timers
- GED-972A—Electronic motor control—Thy-mo-trol
- GEA-3530—Electron-tube control for steel mill application

Name.....

Company.....

Address.....

City.....State.....

8490



THINKING ABOUT THE FUTURE?

When planning new machines, new processes, new factory buildings—LOOK TO ELECTRONICS. Electronic production aids, like these on this page, offer real opportunities for improvements and economies. Come to General Electric for the electronic answer to your problems. General Electric, Electronic Control Section, Schenectady, N. Y.

Speed Production Electronically

GENERAL ELECTRIC



THROUGH NO FAULT OF YOURS?

America cannot afford *dead heroes* through failure of fighting tools. Only maximum reliability is "good enough" for vital war equipment. You can give your product that degree of reliability by using C-Ds when the design calls for capacitors.

Cornell-Dubilier has *specialized* in the manufacture of capacitors exclusively for more than 33 years. The extra measure of stamina this unique experience has built into C-Ds—a competitive advantage in peacetime—is a priceless assurance of reliability in time of war. Cornell Dubilier Electric Corporation, South Plainfield, New Jersey.



Medium Power Transmitter Capacitors
TYPE 30

The type 30 Mica Capacitors in moulded cases are designed for a wide variety of radio frequency applications where size and weight are at a premium. They are being used in aircraft, portable, low and high power transmitters as grid, plate, coupling tank and by-pass capacitors. These units employ the patented series mica stack construction, eliminating corona losses and permitting their use on higher r.f. voltages. Described in detail in catalog No. 160T on request.

Cornell-Dubilier
capacitors

MICA DYKANOL PAPER
WET AND DRY ELECTROLYTICS



MORE IN USE TODAY THAN ANY OTHER MAKE

Dunco Sensitive

RELAYS FOR LOW-POWER USES

TWICE TESTED . . . BALANCED TO STAND VIBRATION

For vacuum tube circuits—for the protection of delicate instrument contacts—for alarm circuits—for exacting temperature control—wherever the need is for dependable relays to operate on very low coil circuit power, you will find Dunco Sensitive Relays unexcelled.

Each unit is specifically "tailored" to its specific job. Each has its moving parts carefully balanced, making

it suitable for use where vibration is encountered. Each is twice-tested before leaving the factory.

Shown here are sensitive relays of the Dunco Series 28 (high-sensitivity), and Series 29 (medium-sensitivity) types available in various styles of mounting. Numerous sensitive Dunco Midget Types are likewise available for similar low-power uses where small size and light weight are important factors.

DUNCO CATALOG AND RELAY DATA BOOK

You can find the right relay for almost any application in the 48-page Dunco Catalog—also helpful engineering information and suggestions on relay selection and use. Copy upon request.



STRUTHERS DUNN, Inc.

1321 ARCH STREET

PHILADELPHIA, PA.

LET DUNCO DISTRICT ENGINEERS IN 28 STRATEGICALLY LOCATED CENTERS HELP SOLVE YOUR RELAY PROBLEMS

Lever Keys, too, Can be "Custom- Built" by CLARE

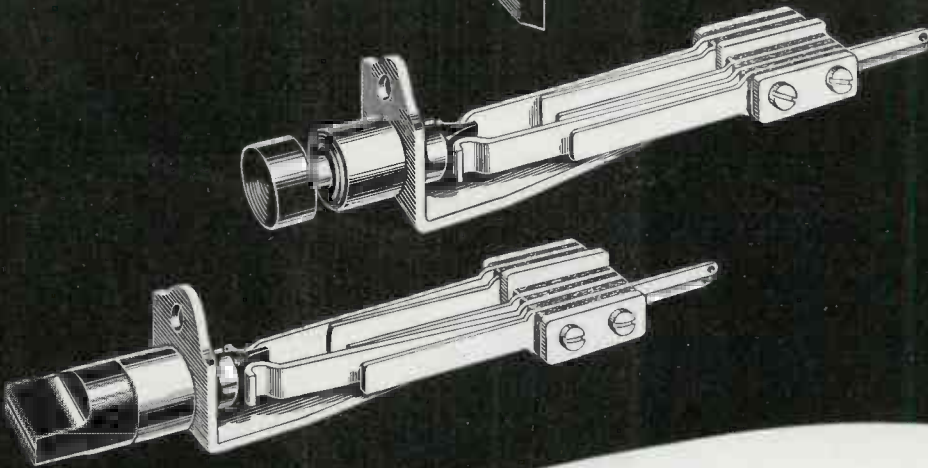
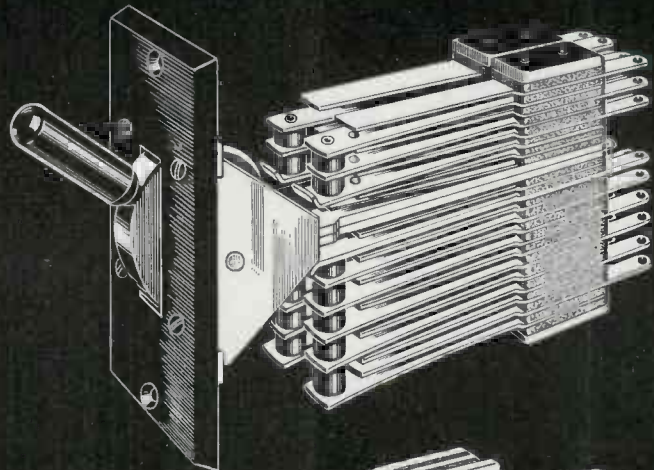

... and so, too, can Push and Turn Keys

The Lever Key illustrated is another example of Clare "custom-building" to meet requirements. Its frame is designed to hold all parts together by their interlocking shapes, then welded to make virtually a "one solid piece frame," to provide maximum rigidity.

The cam assembly is also unique because at the time of manufacture, or at any future time, stops may be provided, added or removed to change the key from locking to non-locking or vice versa. Or it may be changed from one-way to two-way, or vice versa.

The same careful design and construction are typical of the Push Key and Turn Key also illustrated above.

In every feature of design, these keys possess all the construction and design features which make Clare Relays outstanding in performance. Some of these features are listed at the right. Our engineers will be glad to "custom-build" keys to fit your requirements. Write us regarding them. Ask for the Clare catalog and data book. C. P. Clare and Company, 4719 Sunnyside Ave., Chicago, Ill. Sales engineers in all principal cities. Cable Address: "CLARELAY."

- Contact springs are made of nickel silver to exacting specifications.

- Flat or hemispherical contacts of either rare metals or special alloys are "over all" welded to contact springs by a special process which makes them an integral part of the springs, thereby reducing contact resistance to a minimum and providing for rapid heat dissipation.

- Contacts available and their current ratings are as follows:

**Contact Ratings: 110 Volt, 60 Cycle,
A. C. Non-Inductive**

Code No. 1.....	1 Amp. 50 Watts
Code No. 2.....	2 Amp. 125 Watts
Code No. 4.....	3 Amp. 150 Watts
Code No. 5.....	4 Amp. 175 Watts
Code No. 7.....	4 Amp. 175 Watts

- Insulation between springs and between springs and frame may be either single, double or special. Single insulation will stand a 500 volt a.c. test, double insulation a 1000 volt a.c. test, and special insulation a 1500 volt a.c. test. These spring insulators are made from special heat-treated Bakelite that permits punching without cracks or checks and possesses minimum cold flow and low moisture absorption properties.

- Contact forms may consist of any one of the five forms shown below, or of any combination of those forms.

- The Lever Key may incorporate as many as 40 springs, whereas the maximum number of springs that may be had on the Push and Turn Keys is 20.

- Spring bushings of Bakelite are designed under a special secret process providing long wearing features.

- The Lever Key handle is made of catalin, in either polished black, red or white. Push Key buttons and Turn Key knobs are of Bakelite, in black only.

- The Lever Key escutcheon is made of Bakelite and is held to the key frame by four oval head No. 3-48 screws; keys may be furnished with or without escutcheon, depending upon the type of mounting to be used.

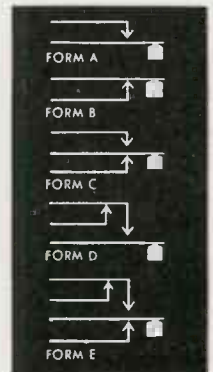

CLARE RELAYS

"Custom-Built" Multiple Contact Relays for Electrical, Electronic and Industrial Use

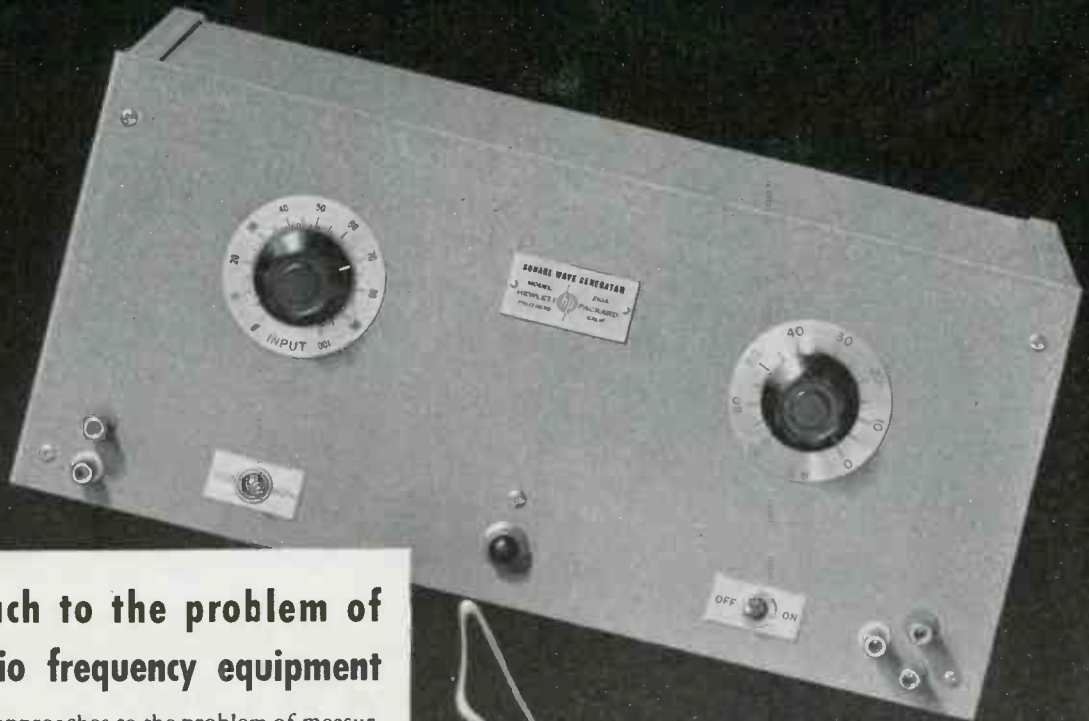

A new approach to the problem of measuring audio frequency equipment

One of the most recent approaches to the problem of measuring the response of amplifiers and networks is to apply a square wave voltage and observe shape of the wave which is transmitted. The frequencies contained in a uniform square wave are given by the relation:

$$f(t) = \frac{4}{\pi} (\sin \omega t + \frac{1}{3} \sin 3 \omega t + \frac{1}{5} \sin 5 \omega t + \dots)$$

In practice a wave which appears to be perfectly square will contain thirty harmonics or more and when the amplitude or phase relation of the harmonics is disturbed the square wave will be distorted. Thus the application of a square wave to circuit shows up any irregularities in the amplitude or phase transmission of that circuit not only at the square wave frequency but also at frequencies far removed from the test point.

The square wave test is particularly important in feedback circuits where the circuit performance outside the normal transmission band is generally of interest. The application of a square wave test to a feedback amplifier will show in a single observation whether the amplifier is close to oscillation point.

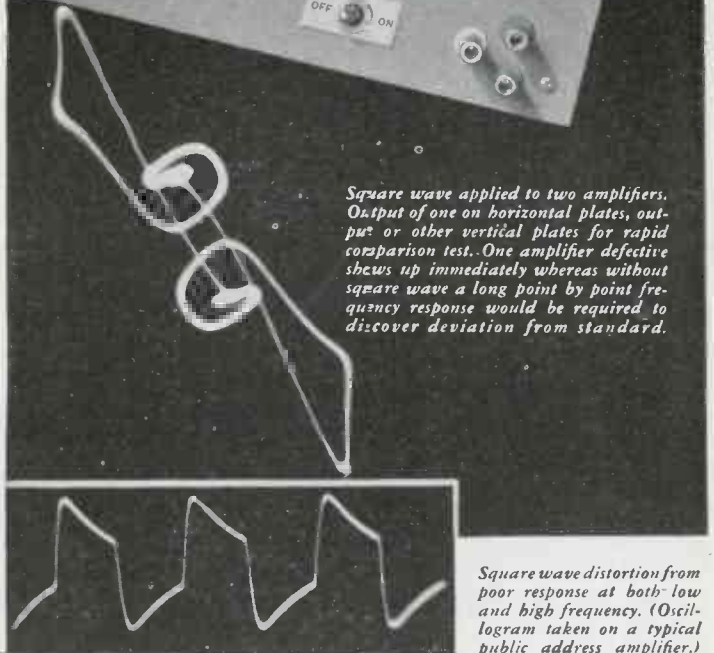

Square wave applied to two amplifiers. Output of one on horizontal plates, output on other vertical plates for rapid comparison test. One amplifier defective shows up immediately whereas without square wave a long point by point frequency response would be required to discover deviation from standard.

Square wave distortion from poor response at both low and high frequency. (Oscillogram taken on a typical public address amplifier.)

SPEED UP PRODUCTION AND DEVELOPMENT WORK

 This Square Wave Generator will help you in Production and development work on A. F. amplifiers. As a general purpose instrument for laboratory work and as a time saver in production testing a square wave generator is an important instrument.

The *hp* model 210 Square Wave Generator provides an excellent square wave and is more useful than other instruments of this type because the frequency can be accurately set for quantitative measurements of decrement factor, time and other quantities to transient analysis. It will save valuable time in production testing because one or two observations will check the frequency response of apparatus where heretofore a large number of observations were necessary. This new instrument is an important tool for development work because it will show up phase shift and transient effects, both of which are rather difficult to study by other methods. In one observation a square wave applied to amplifier will check a wide frequency range, a range of 100 to 1 or

even more. This is extremely important because once the proper criterion has been established a production test can be set up with one or at the most two observations with a square wave.

No priority needed to avail yourself of our engineering help but *hp* instruments are going all-out for war and quick deliveries can be made only to people engaged in the war effort. However, we are making prompt deliveries to war plants and our capacity for fast production is ample. Write today for information.

Square wave test on feedback amplifier showing amplification peak at 9 times square wave frequency. (A normal frequency response measurement shows flat response from 20 cps to 20 ks.)

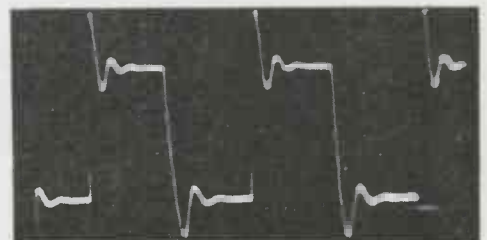

HEWLETT-PACKARD CO.

BOX 1135 K, STATION A - PALO ALTO, CALIF.

CRYSTALS



"SHORT ORDERS" IN A HURRY

If it's a "Rush" phone call, and your order for special crystals will go into work immediately, under a competent crystal engineer personally charged with the responsibility for your project.

Our full facilities, including latest electrical and optical equipment, X-ray orientation, etc.—are at your service. John Meck Crystals are "Good Will Ambassadors of the Future" to acquaint you with our Family of Activities in the field of Sound and its Projection. That's why "Short Orders in a Hurry" are welcome.



Phone **CRYSTAL SERVICE DIVISION**
PLYMOUTH THREE THREE

JOHN MECK INDUSTRIES
PLYMOUTH, INDIANA



On Time!

QUICKER DELIVERY FOR STEATITE INSULATORS



Not so long ago, an order for Steatite Insulators brought a sympathetic shrug of the shoulders and a "Sorry, five to six months delivery." We did not like to tell our customers that. We did not like it because we knew how badly Steatite was needed for the war effort.

This is what we did to quicken deliveries of Steatite Insulators.

- Expanded our plant facilities.
- Enlarged our staff of engineers and technicians.
- Devised improved methods of production.

As a result, there rolls from our kilns every month increasing quantities of insulators. Gradually, but surely the backlog of orders was reduced. Now we can promise our customers deliveries on standard parts from stock in a reasonably short time.

If you have any insulator problem—whether specialized or standard—we would like a shot at it. You can rest assured that your requirements will receive prompt, individual attention.

Above . . . stock insulators such as these are now available in quantity for prompt delivery. Write for data concerning the many different types of Steatite Insulators.

Left . . . these coil forms and insulators were designed and pressed for special applications where stock insulators would not serve. They are working examples of the engineering skill available for your special insulator problem.



⊕ 3573

General Ceramics

AND STEATITE CORP.
KEASBEY NEW JERSEY



NOW!

Erie "Hi-K" Ceramicons

REG. U. S. PAT. OFF.

IN CAPACITIES UP TO 16,000 MMF

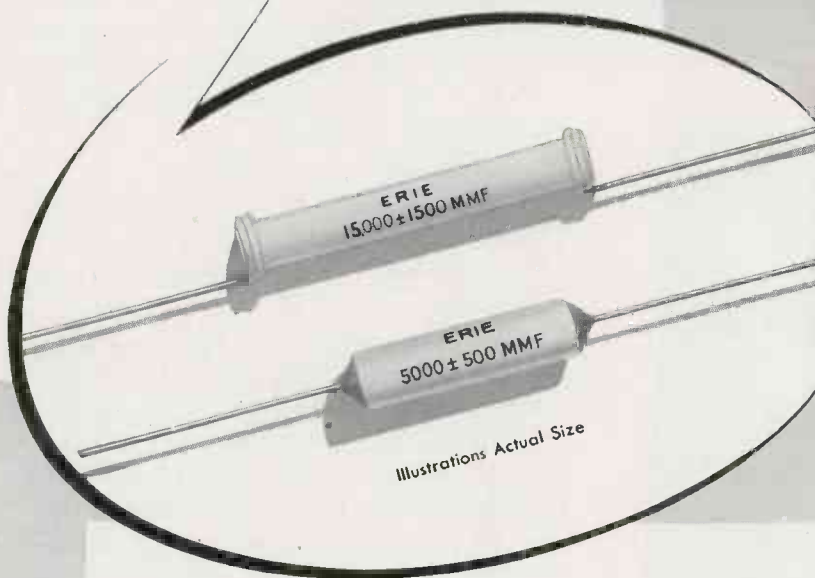

Capacity Range: Maximum capacity, insulated style 5,600 MMF; Non-insulated, 16,000 MMF. Minimum tolerance, $\pm 10\%$.

Working Voltage: 500 volts D.C. up to 60°C. Flash test 1,000 volts D.C.

Maximum Power Factor: 2.5% at 25°C.

Initial Leakage Resistance: Over 5,000 megohms at 1,000 volts D.C. at 25°C.

COMPACT, HIGH CAPACITY, CERAMIC CONDENSERS

ERIE is now in production on a group of new "Hi-K" Ceramicons in capacities up to 16,000 MMF. Behind these units are nearly 7 years of experience in producing silvered-ceramic condensers and over 1½ years of research and development of these high dielectric ceramic units.

Present Erie "Hi-K" Ceramicons have a dielectric constant (K) of 1050 at 25°C, and are available in the capacity range listed above. Insulated units are encased in a sealed ceramic sleeve. Non-insulated units have an extremely hard white protective coating.

The announcement of Erie "Hi-K" Ceramicons has been purposely withheld until they were developed to a point where they would successfully fulfill present day requirements. These units have very high and changing temperature coefficient and are recommended for use as by-pass or blocking condensers where high stability and high leakage resistance is not essential. The ratings of these capacitors, shown in the above panel, are conservative and are indicative of their operating performance.

Interested engineers are invited to write for samples to test in their laboratory.

ERIE RESISTOR CORP., ERIE, PA. LONDON, ENGLAND · TORONTO, CANADA.

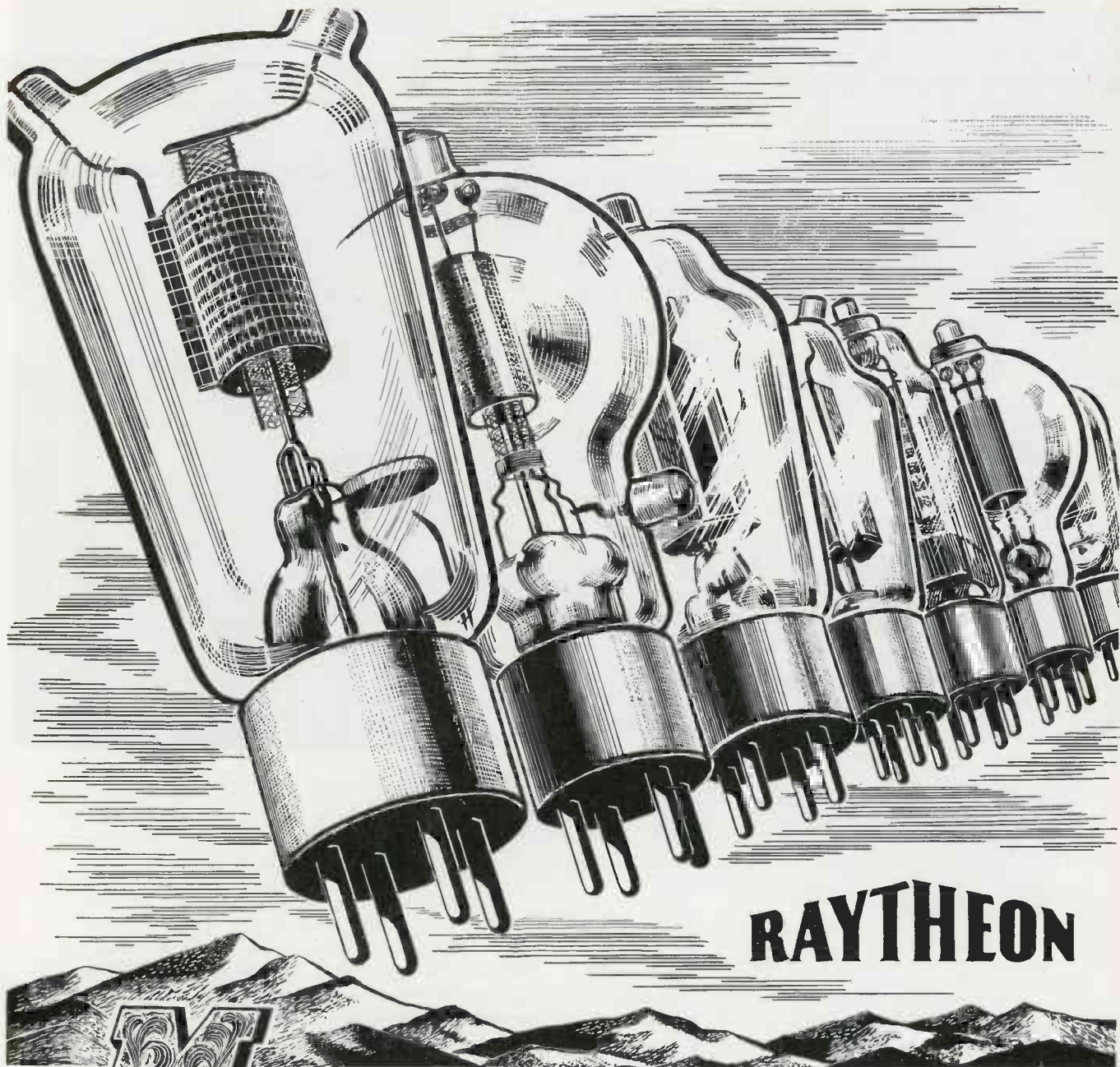

RAYTHEON

M

ILEPOSTS IN THE PROGRESS OF RESEARCH!

RAYTHEON tubes for the peacetime electronic era will incorporate all of the engineering skill gained through scientific accomplishments in wartime.

Your new RAYTHEON tubes will be adaptable to a wide scope of newly developed uses . . . with performance characteristics that have been time-tested through service in stringent military campaigns.

You can look to RAYTHEON leadership when you again purchase tubes . . . no matter what type of function your requirements may be . . . you will find a RAYTHEON tube designed and engineered to faithfully perform its task.

For military reasons tubes illustrated are not a new development.

Raytheon Manufacturing Company

WALTHAM AND NEWTON, MASSACHUSETTS

DEVOTED TO RESEARCH AND THE MANUFACTURE OF TUBES AND EQUIPMENT FOR THE NEW ERA OF ELECTRONICS

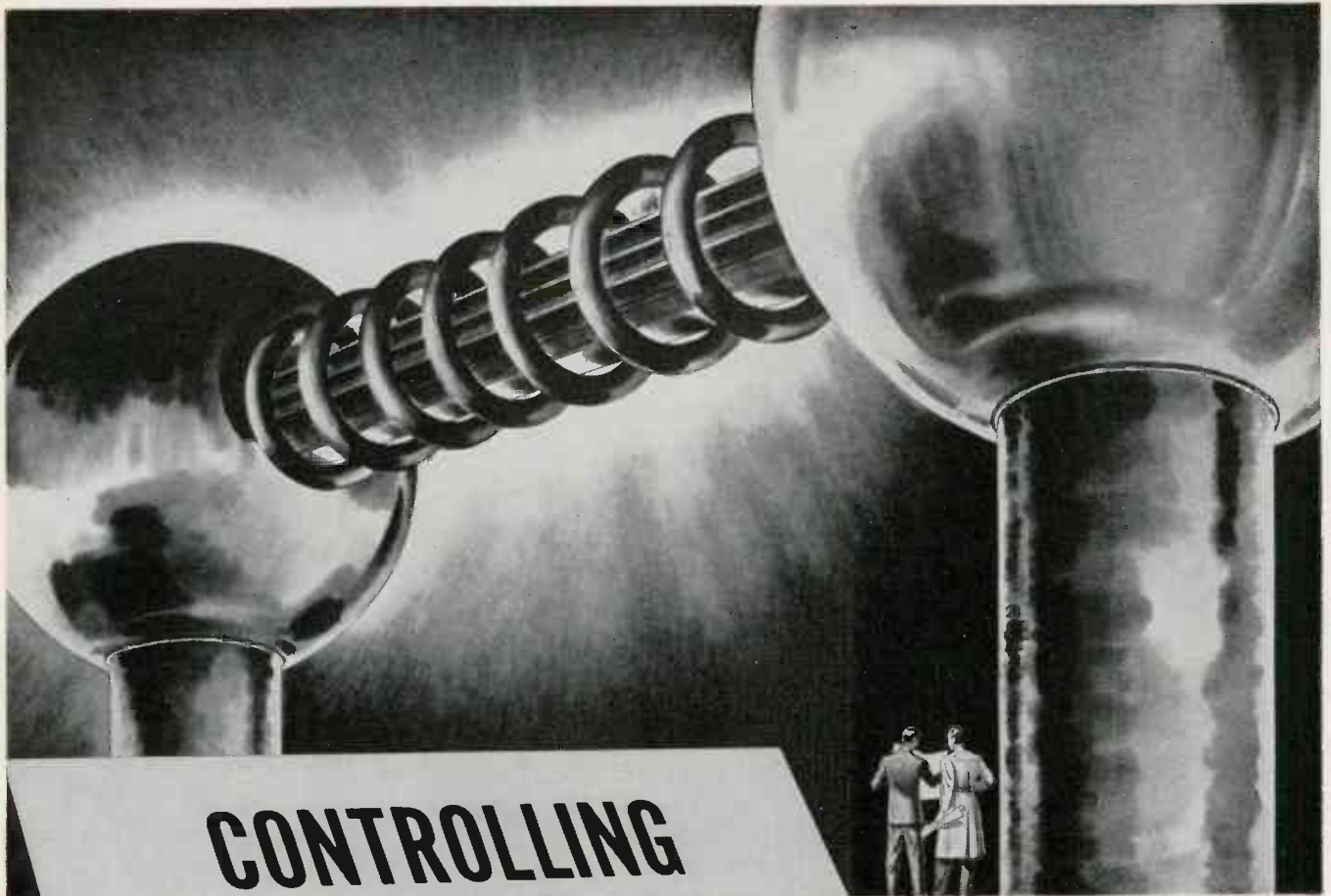

Electron beam tube of atom-smasher.

CONTROLLING MILLIONS OF VOLTS!

In the vast new province of Nuclear Physics the atom-smashing "Big Guns"—the Van de Graaff generators, the cyclotrons and betatrons—are carrying on a campaign of *creative* destruction.

Manned by an army of collaborating specialists, this massive and complex artillery has already achieved spectacular results in the medical, chemical and biological fields and in scientific developments which must remain secret for the duration. The "smashing" of atoms has released new energies, created new atoms.

Despite the tremendous force required to produce high-speed electrons, protons and ions, the controls and measuring devices perform with amazing accuracy.

IRC is proud to have contributed to the development of resistor units, both Wire Wound and Metallized—of fixed and variable types—used in the measuring instruments. And IRC

engineers have produced special resistors used to stabilize corona and other disturbing phenomena in atom-smashers.

If you are confronted with a problem involving resistance devices, we invite your inquiry. Our engineering staff, specialists in the design of all types of resistors, can be depended upon for impartial counsel.



INTERNATIONAL RESISTANCE COMPANY

425 N. BROAD ST., PHILADELPHIA



▶ Recently a new type cathode-ray tube was called for by our armed forces. Just an idea—something arising out of new conditions—not yet reduced to actual practice—and of course far from production.

Opinion generally was that this new tube might require months to develop, design, produce. Yet DuMont, with its exceptionally close coordination of experimental tube work and actual production, was actually ship-

ping that very tube in quantities within 10 days.

It is performance such as this that has made the name DuMONT the accepted abbreviation for "Cathode-Ray Tube Headquarters."

▶ Write for latest listing of cathode-ray tube types. Also bulletins on latest cathode-ray equipment. Submit your problems.

▶ **DUMONT**

**ALLEN B. DU MONT
LABORATORIES, Inc.**

Passaic • New Jersey
Cable Address: Wespealin, New York



RESISTORS ON 24-HOUR WATCH



RHEOSTATS



RELAYS



RESISTORS

Electrical equipment aboard ship has no off-duty time. Radio, inter-communication, air conditioning, ventilation, refrigeration, deck machinery, gun operation and innumerable other vital services employ resistors in their control circuits. These resistors must be dependable to function at all times. Ward Leonard Vitrohm Resistors have measured up to their responsibilities. Their ability to withstand moisture, temperature change, shock and vibration makes them particularly well fitted for sea duty. Resistors with the same ruggedness as those used by the Navy and Merchant Marine are available to all industry engaged in victory production. Send for data sheets.



WARD LEONARD

Electric control  devices since 1892.

WARD LEONARD ELECTRIC COMPANY, 61 SOUTH STREET, MOUNT VERNON, NEW YORK



ON THE JOB

Whenever our Flying Fortresses fulfill their missions for victory, AlSiMag ceramic insulators are on the job to help make the flight a success.

AlSiMag steatite insulation can be found in all vital electronic components and is selected by designers of electronic equipment for dependable service.

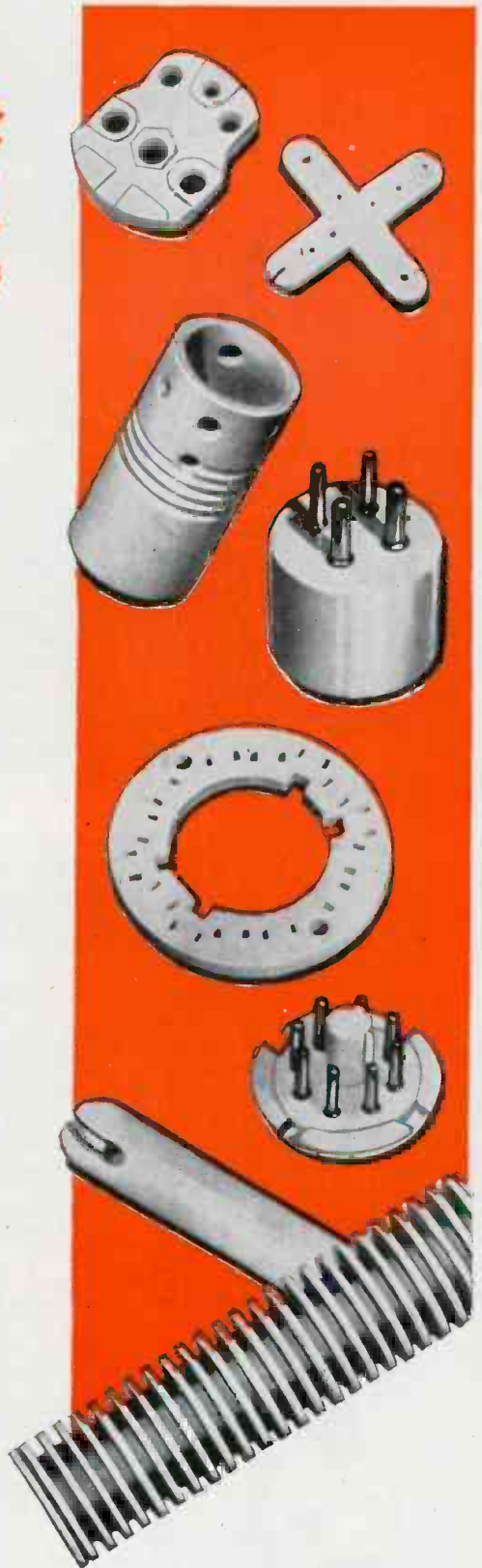

AWARDED JULY 27, 1942

ALSiMAG <small>TRADE MARK REGISTERED U. S. PATENT OFFICE</small>	AMERICAN LAVA CORPORATION CHATTANOOGA, TENNESSEE
--	---



OFFICIAL U. S. NAVY PHOTOGRAPH

ALL-AMERICAN TEAMWORK - 1943

SIGNALS are called or a "flat-top" . . . and a smooth-working team of men and equipment swings into action. The hardest game of all begins — War — with death-dealing steel and men's lives at stake.

Networks of communications systems become the nerve center of action. Microphones at battle stations carry the signals to the team. Men rely upon their Microphones in the thick of the fight. They must get the signals through.

Shure Microphones are made to work under fire. They achieve new standards of ruggedness. They will get the signals to the team and help coordi-

nate the efforts of every fighting man for Victory.

SHURE REACTANCE SLIDE RULE



Makes extremely simple the calculation of complicated problems in resonant frequencies. Also helps in the solution of circuit problems involving inductances and condensers. Covers a frequency range of 5 cycles per second to 10,000 megacycles. Indispensable for radio and electrical engineers, technicians and circuit designers. Send 10c in coin to cover mailing costs.

Shure Brothers are supplying Microphones to all of our armed forces. Additional plant capacity is available to Manufacturers who require Microphones for their contracts.

SHURE BROTHERS, Dept. 174K 225 West Huron St., Chicago, U. S. A.
Designers and Manufacturers of Microphones and Acoustic Devices



MICROPHONES



OFFICIAL U. S. NAVY PHOTOGRAPH

electronic briefs: television

To produce a moving picture it becomes necessary to break down the action into a series of still pictures. Each still scene is flashed on the screen individually but done so rapidly that the human eye sees a smooth action. If the motion picture projector is slowed down the action becomes jerky. Each still picture is called a frame. The conventional movie projector flashes between 24 and 30 frames per second on the screen. Television is based upon the same principle but the problems involved are much more complex.

Television, using the same basis for creating picture action as the movies, breaks down the picture or scene to be broadcast into a series of still pictures called frames. But each frame must also be broken down into approximately 200,000 tiny segments, each segment being 30 frames per second and reassembled at the receiving end so rapidly that 30 frames can be flashed on the screen every second. Thus some 6,000,000 separate signals must be transmitted per second. Furthermore each of these signals starts as light, is converted into an electrical impulse, broadcast and then reconverted to light again. To make television talk, a conventional sound transmitter must be coordinated and synchronized with the picture broadcast.

As with all things in the field of electronics, vacuum tubes are what make television possible. Remember; Eimac tubes enjoy the enviable distinction of being first choice among leading electronic engineers throughout the world.



EITEL-McCULLOUGH, INC., SAN BRUNO, CALIFORNIA
EXPORT AGENTS: FRAZAR & HANSEN, 301 CLAY ST., SAN FRANCISCO, CALIF., U. S. A.

Follow the leaders to

Eimac
REG. U. S. PAT. OFF.
TUBES

Army-Navy "E"
flag awarded for
high achievement

ENGINEERS!

CHECK THESE SIX
OUTSTANDING FEATURES OF

NEW

1 MINIMUM FREQUENCY DRIFT

Absence of hot flow and cold flow, maximum dimensional stability and minimum expansion combine to provide a minimum of frequency drift. Often it is not necessary to use crystals or other compensating devices.

2 NEGLECTIBLE WATER ABSORPTION

Multiform glasses show a water absorption of less than 0.01 per cent (24 hours). Impregnants or added glazes are unnecessary, assuring better dimensional tolerances. Loss of efficiency due to improper impregnation or cracked glaze is eliminated.

3 LOW LOSS FACTOR

Insulators, made from Multiform glasses, offer you definitely greater efficiency. Multiform glass #707, for example, has a loss factor of only 0.40 at 20°C, —1 Meg.

4 UNIFORM ACCURACY

Threads, grooves and holes are accurate from piece to piece because they are molded in the piece. All sizes can be made with tolerances of $\pm 2.0\%$, not less than $\pm 0.010''$.

5 EXTREMELY WIDE RANGE OF SIZES AND SHAPES

There's almost no limit on shapes, cylindrical or flat. In size, pieces range from tiny beads, several thousand to the pound, to 25-lb. pieces 15" or more across.

6 HIGH DIELECTRIC STRENGTH

Multiform glasses have a dielectric strength of 500 volts per mil or more—approximately twice the dielectric strength of porcelains and steatites.

CORNING MULTIFORM GLASS INSULATION

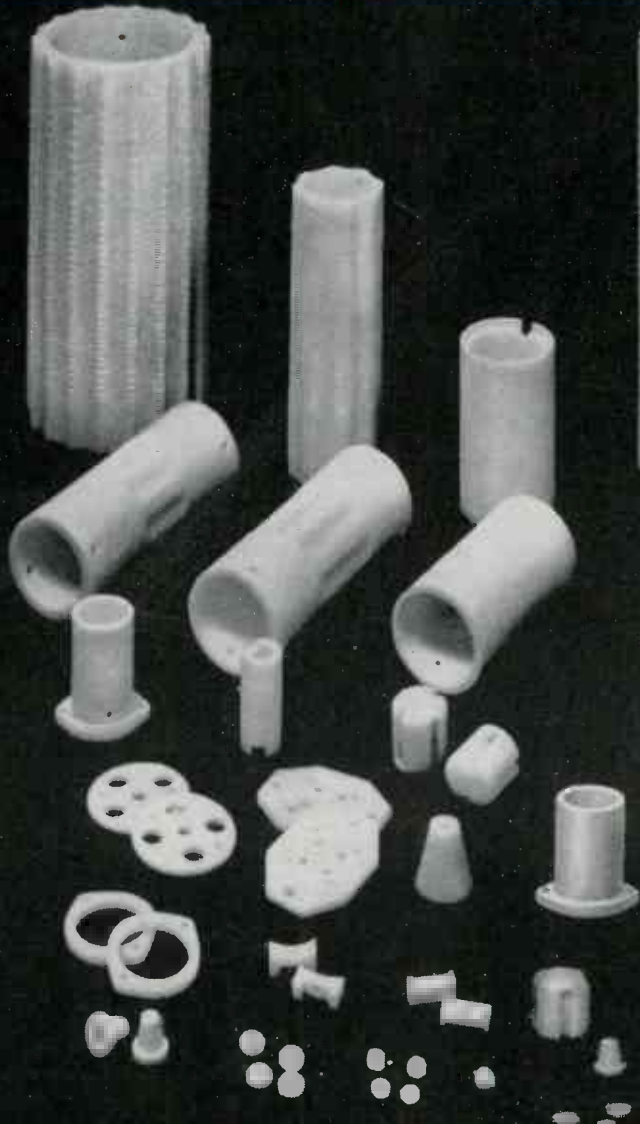

NO SHORTAGE OF GLASS TO REPLACE STEATITE, PORCELAIN AND OTHER ELECTRICAL INSULATION MATERIALS

DELIVERIES slow on electrical insulators? Here's good news! New-type insulators developed by Corning Glass Research—Pyrex brand Multiform Glassware—are available now! Check the six outstanding features on the opposite page. See why all Multiform glasses not only comply with the proposed A.S.A. American War Standard on Radio Insulation Materials of Low Dielectric Constant, but actually offer you more in efficiency and long life!

The characteristics of these glasses plus Corning's new fabrication methods make possible an extremely wide range of shapes and sizes. General dimensional tolerances are: large or heavy pieces, intricate shapes, hollow cylindrical sections— $\pm 2.0\%$ or $0.010''$; flat plates, solid rods, discs, beads, bushings— $\pm 1.0\%$ or $0.005''$, except thickness which should be $\pm 4\%$ or $0.005''$.

If you have an insulator problem, do this today: Fill in and mail the coupon now for a free sample of Pyrex brand Multiform Glass and complete, descriptive booklet.

**MAIL COUPON TODAY FOR
FREE SAMPLE AND DATA !**

Pyrex Insulators
BRAND

Corning Glass Works, Corning, N. Y.
Insulation Division, Dept. EI-7
Please send me immediately, without charge,
sample and descriptive booklet on new Pyrex
brand Multiform Insulators.

Name

Company

Street Address

City State

"PYREX" is a registered trade-mark and indicates manufacture by Corning Glass Works

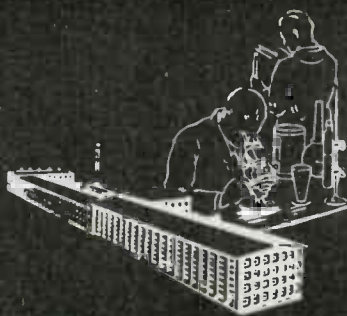

A Special Message

*to men who buy capacitors
for war equipment*

Over 80% of the Capacitor types Sprague is making today were not being made two years ago. Practically all of these are special types developed by Sprague engineers to match specific war requirements.

This means two things to you as a buyer:

First, it means that capacitor problems do not stay answered. Capacitors that were "good enough" a few months ago, may be entirely outmoded by new developments. Reversely, types not thought suitable for certain applications may have been improved to a point where their use is entirely practical—as witness Sprague's pioneering of satisfactory electrolytic capacitors for airplane use.

Second, it means that Sprague is in the forefront of capacitor production for war uses. We don't pretend to have all the answers—but we do have a sufficiently large number of them that leading users find it pays to contact Sprague *first*, whatever their problem. Paper capacitors that stand up

under kilovolts at 110° C.; paper units to serve as satisfactory mica capacitor substitutes; capacitors that will stand pulse voltages; paper capacitors that read "off scale" on megohm meters (more than 200,000 megohms)—such are but a few of the more recent Sprague developments. Back of each type is a broad background of engineering experience in today's critical uses that is freely available to our customers. We cordially invite you to make full use of it.

SPRAGUE SPECIALTIES COMPANY
North Adams, Mass.

**SPRAGUE
CAPACITORS
& KOOLOHM RESISTORS**



On Pan American's "LITTLE SISTER TO THE CLIPPER"



Micro Switches Act Dependably as Landing Gear Limit Switches

Illustrated here is one of the Pan American Airways' huge 42½ ton Transocean Clippers. In the inserts are shown the landing gear and the Micro Switches which are used as limit switches on Pan American's Grumman Widgeon trainers. This plane is often referred to as the "Little Sister to the Clipper."

These trainers are used for training the intrepid pilots who fly the giant Clippers over the seven seas. Because of the nature of the work performed, it is obvious that every precaution must be taken, every contingency provided for. That is why Pan American depends on the rugged dependability of Micro Switch.

Thumb-size and feather-light, Micro Switch is amazingly rugged, resists vibration, and requires no leveling. It operates precisely at the same point for millions of operations with lightning-fast contact action. It is accurately built to exact standards from precisely made parts. Its performance characteristics can be changed to meet functional requirements.

Micro Switches are used to perform many different

functions in aircraft. Special brackets, actuators, and aluminum housings are available for this purpose. For heavy duty service such as machine tools, there are Micro Switches enclosed in steel which can be sealed against dirt, dust, water, oil, metal chips and other foreign particles.

All Micro Switches can be supplied with a variety of actuators to meet all needs. Micro Switches operate on pressures as low as one ounce and movements as low as .0002". Micro Switch is listed by Underwriters' Laboratories with ratings of 1200 V.A. loads, from 125 to 600 volts A.C.

Every engineer should have a copy of Micro Switch Handbook Catalogs which tell and illustrate the principles and applications. Handbook Catalog Number 60 deals with Micro Switch in general, and Number 70 is written specifically for aircraft applications.

Micro Switch Corporation, Freeport, Illinois
Branches: 43 E. Ohio St., Chicago • 11 Park Place, New York City
Sales and Engineering Offices: Boston • Hartford • Los Angeles

The trademark MICRO SWITCH is our property and identifies switches made by Micro Switch Corporation

© 1943

M I C R O S W I T C H

Made Only By Micro Switch Corporation... Freeport, Illinois



F.M. Emergency Communications

by *Motorola*

RADIO ENGINEERING FOR TODAY
that means a lot for Tomorrow

Pioneers in the development of Portable and Mobile F-M and A-M Radiotelephone Equipment, Motorola engineers are today applying their accumulated skills and scientific knowledge to solving problems which confront our country, its states, counties, cities and towns. Housed in a new Engineering

Building with expanded facilities for research and engineering, the Motorola capacity for vital service is greater than ever. Electronic knowledge thus gained will one day soon be applied to the normal peacetime demands of a nation eager for better things in all phases of its living.



THE ARMY-NAVY "E"—Awarded for excellence in the production of Communications Equipment for America's Armed Forces

Motorola Radio Communication Systems
Designed and Engineered to Fit Special Needs
GALVIN MFG. CORPORATION • CHICAGO

FROM PHOTO-FINISH SCOREBOARDS

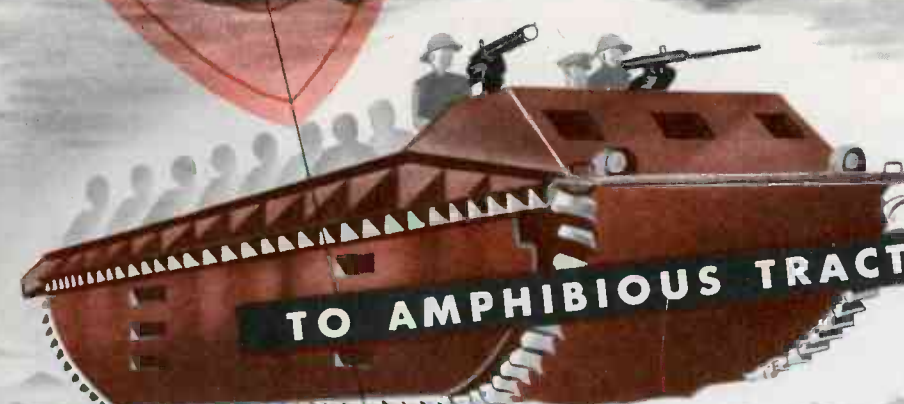

RELAYS BY GUARDIAN MEET ALL CONTROL NEEDS

★ Whether the principle is electronic or magnetic . . . whether the job requires a tiny A.C. relay or a heavy-duty D.C. solenoid . . . whether time delay or instantaneous action . . . there is usually a "Relay by Guardian" to meet the "specs" on most applications . . . from animated electric signs to electric chokes for the Army's amphibious tractors.

SIGNAL CORPS RELAYS—The Signal Corps Relay shown at the right is used for starting dynamotors in portable radio equipment. It is a single pole, double throw relay having contacts rated at 16 amperes at 12 volts D.C. continuous. Coil voltage ranges from 9 to 14 volts D.C. Other Signal Corps "Relays by Guardian" include a relay for change-over from transmitting to receiving and a keying break-in relay for mobile radio equipment.

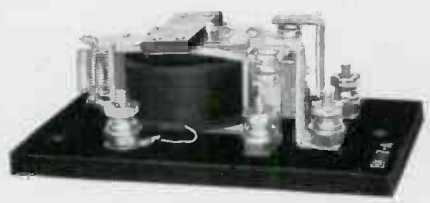

Signal Corps Relay

Write for bulletin 195 describing Signal Corps "Relays by Guardian."

GUARDIAN  **ELECTRIC**
 1622-D WEST WALNUT STREET CHICAGO, ILLINOIS

A COMPLETE LINE OF RELAYS SERVING AMERICAN WAR INDUSTRY

one style case...

THE ADVANTAGES OF A COMPLETE LINE HOUSED IN A SINGLE MOUNTING STYLE

STANCOR Professional Series Transformers' case design combines a smart appearance and uniform pattern with rugged mechanical construction. The reversible mounting feature increases the range of application. Uniform mounting centers are maintained for each case size; thus,

accurate chassis punchings may be made with assurance of easy installation or replacement.

This line of Stancor transformers combines sound engineering with highest quality materials and precision manufacturing. No sacrifice of quality is tolerated.

For further information write for catalog No. 240

STANDARD TRANSFORMER CORPORATION
1500 NORTH HALSTED STREET • CHICAGO

DIMENSIONS					
Professional Series Transformers					
Case Type	H	W	L	MW	ML
RA	2 ⁷ / ₈ "	2"	2 ⁷ / ₁₆ "	1 ⁹ / ₁₆ "	2 ¹ / ₃₂ "
RB	3 ¹ / ₁₆ "	2 ³ / ₈ "	2 ³ / ₄ "	1 ¹³ / ₁₆ "	2 ¹ / ₈ "
RC	3 ⁵ / ₈ "	2 ⁹ / ₁₆ "	3 ¹ / ₁₆ "	1 ¹⁵ / ₁₆ "	2 ⁷ / ₁₆ "
RD	3 ⁷ / ₈ "	3"	4 ¹ / ₂ "	2 ⁷ / ₁₆ "	3 ⁷ / ₈ "
RE	5"	3 ⁷ / ₈ "	5"	3 ³ / ₁₆ "	4 ⁵ / ₁₆ "
RF	5"	4 ¹ / ₂ "	5"	3 ²⁷ / ₃₂ "	4 ⁵ / ₁₆ "
RG	5"	5 ¹ / ₈ "	5"	4 ¹ / ₂ "	4 ⁵ / ₁₆ "
RGA	7 ¹ / ₈ "	5 ¹¹ / ₁₆ "	6 ⁹ / ₁₆ "	4 ¹³ / ₁₆ "	5 ³ / ₄ "
RH	9"	7 ¹ / ₂ "	7"	6 ¹ / ₂ "	6"
RJ	9"	8 ³ / ₄ "	7 ¹ / ₂ "	7 ³ / ₄ "	6 ¹ / ₂ "
RK	9"	8 ³ / ₄ "	9"	7 ³ / ₄ "	8"
RL	13"	8 ³ / ₄ "	10"	7 ³ / ₄ "	9"

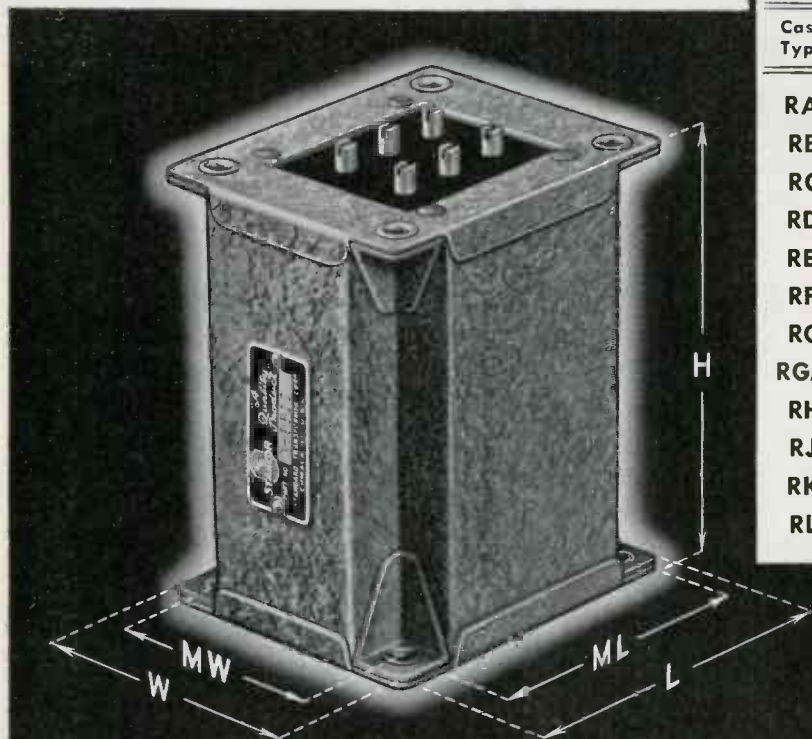

STANCOR



NEW ERA..COME IN NEW ERA

photo by courtesy of Mt. Wilson Observatory

This is a call to the electronics industry of the future.

In a not too distant tomorrow, men will be coming back from battlefields . . . coming out of secret-enshrouded plants to open the doors to this new era . . . to push forward the limits of man's knowledge with the magic of electronics.

Who knows the scope? Private radio phones around the world through space . . . news as it is made, brought visibly to your home . . . new processes in industry

. . . new conveniences in the office . . . things scarcely dreamed of made commonplace by the electronic control of sound and light and motion.

TUNG-SOL will play its part in this new era. Electronic devices will find life through the medium of TUNG-SOL tubes for transmission, reception and amplification. Manufacturers desiring to use electronic controls will find at TUNG-SOL a staff of research engineers to help them create, develop and produce.

TUNG-SOL

vibration-tested

RADIO TUBES



TUNG-SOL LAMP WORKS INC., NEWARK, N. J., Sales Offices: ATLANTA, CHICAGO, DALLAS, DENVER, DETROIT, LOS ANGELES, NEW YORK
ALSO MANUFACTURERS OF MINIATURE INCANDESCENT LAMPS, ALL-GLASS SEALED BEAM HEADLIGHT LAMPS AND THERMAL SWITCHES

New-OPERATING TIPS FOR DI-MET RIMLOCKS

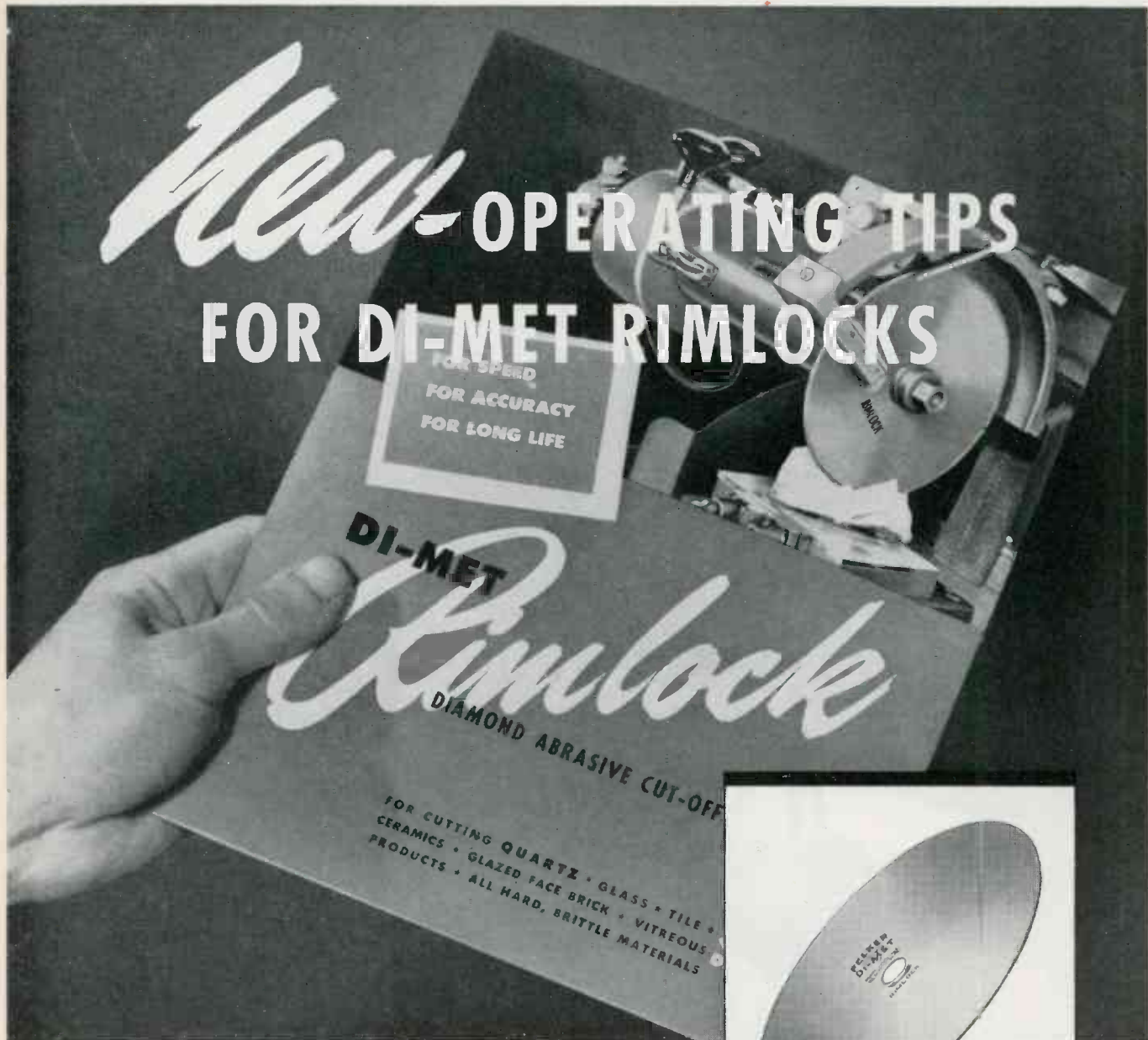

Recommended procedures that cut more quartz per blade, increase cutting speed and improve surface finish

This new DI-MET RIMLOCK folder provides up-to-date information on proper Rimlock operation when used for cutting quartz. It covers such subjects as speeds, feeds, coolants, sharpening and power . . . explains causes of unnecessary dulling and how to avoid them . . . recommends proper feeds for maximum production and long life . . . tells why Rimlocks cut faster! Your copy will be mailed immediately upon request.

FELKER MANUFACTURING COMPANY
1114 BORDER STREET, TORRANCE, CALIFORNIA

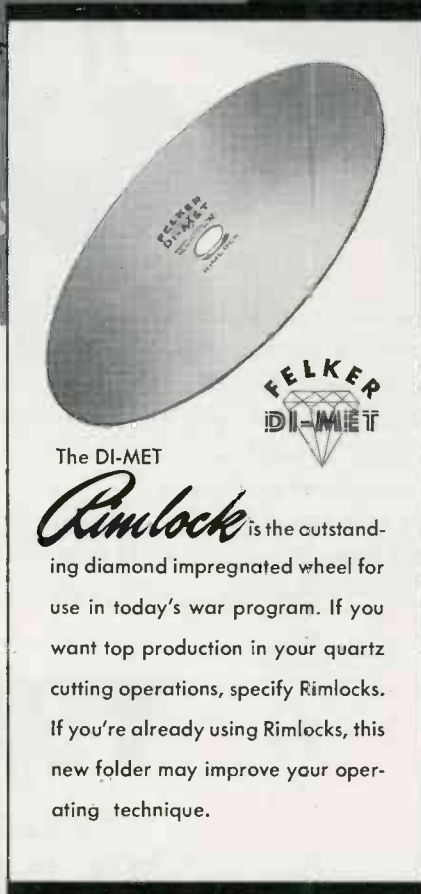

The DI-MET

Rimlock is the outstanding diamond impregnated wheel for use in today's war program. If you want top production in your quartz cutting operations, specify Rimlocks. If you're already using Rimlocks, this new folder may improve your operating technique.

MANUFACTURERS OF DIAMOND ABRASIVE WHEELS

For cleaning up
the enemy now...



...or cleaning up the
home tomorrow

Coils are one of the tremendous trifles of this war. Many of them, in various designs for all kinds of military purposes, are either manufactured by Anaconda or wound with Anaconda magnet wire. With victory, these important trifles will be eager to fill your urgent peacetime needs.

Make a date with us for the peacetime tomorrow

Perhaps we can talk about a coil problem . . . how thoroughly we're organized to help you on such a problem only military censorship forbids telling now. Or it may be that you manufacture your own coils and will be interested in discussing magnet wire—any shape—any insulation.

As a matter of fact, perhaps we can get together now, but if it happens we can't, remember we have a date in and for the future.

When we both can keep it you can again take advantage of Anaconda service and the benefits derived from the single product control 'from mine to consumer' backed by years of continuous metallurgical experience.

43220

ANACONDA WIRE & CABLE COMPANY
General Offices: 25 Broadway, New York
Chicago Office: 20 North Wacker Drive
Subsidiary of Anaconda Copper Mining Co.
Sales Offices in Principal Cities



This familiar trade-mark symbolizes the best efforts of modern research and production.



Magnet wire and coils

ANACONDA WIRE & CABLE COMPANY

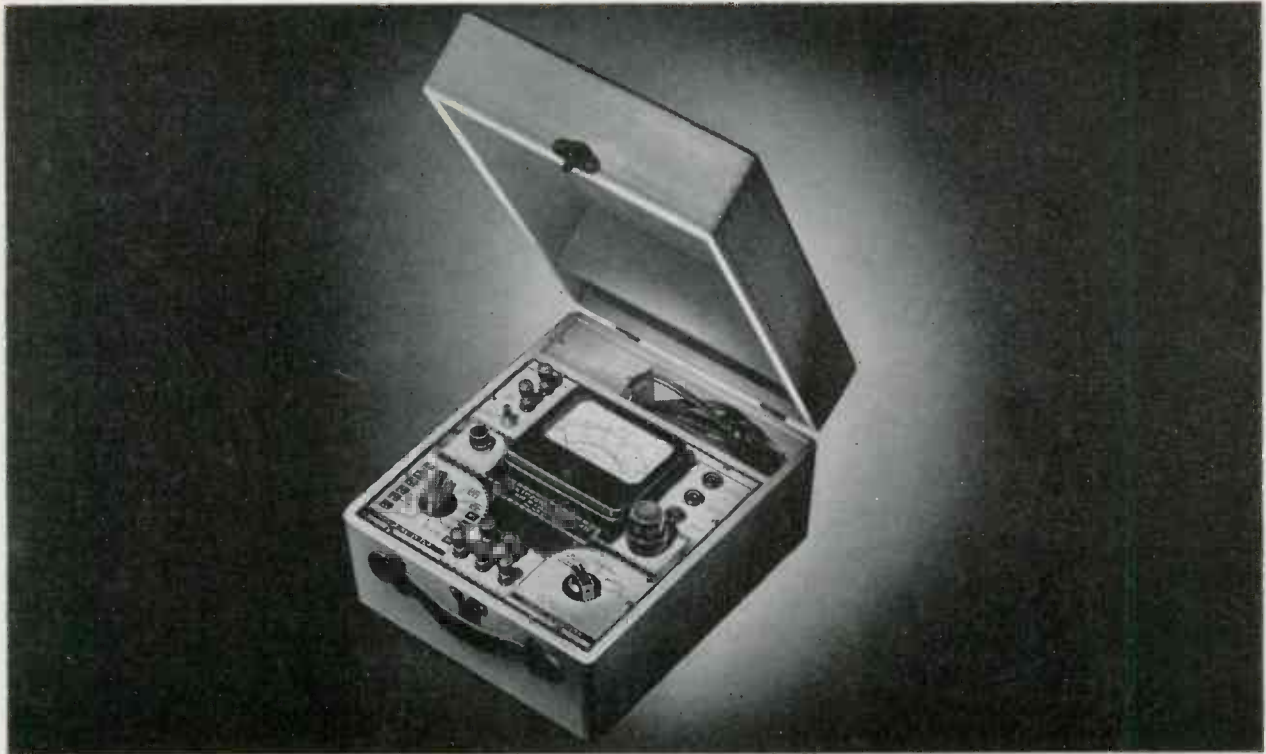

UNIVERSAL DE LUXE MULTITESTER

★ The original, advanced design features of the Model 419 Universal Multitester make it ideally suited for a wide range of applications in both the laboratory and factory.

The R.C.P. system of A.C. measurements eliminates troublesome copper oxide rectifier. Rectifier used is more rugged, sensitive, easier to replace and more economical. It is not subject to the frequency, wave form and temperature errors found with copper oxide rectifiers.

- ★ A.C. Meter scales are linear and coincide with D.C. scales.
- ★ Meter sensitivity is 2000 ohms per volt.
- ★ Direct reading, capacity meter with wide spread scales.
- ★ Ohmmeter has self contained power supply.
- ★ Ultra sensitive low ohm ohmmeter range ideal for detecting shorted turns, contact resistance, voice coils resistance, etc.
- ★ Inductances can be computed with graph supplied.
- ★ Meter completely fused.
- ★ Supply line is double fused.
- ★ Special position for checking output voltages.
- ★ New improved terminals replace conventional jacks.

Ranges:—

- D.C. voltmeter:—0-5-50-250-2,500-5,000 volts.
- A.C. voltmeter:—0-10-100-500-1,000-5,000 volts.
- D.C. milliammeter:—0-1-10-50-250-1,000 ma.
- D.C. ammeter:—0-1-5-25 amps.
- Capacitometer:—0-.03-.30-3.-30-300 mfd.
- Low ohmmeter:—0-100 ohms.
- Ohmmeter:—15,000-150,000 ohms.
- Megohmmeter:—0-1.5-15 megohms.
- Inductance measurements—chart reference:—

0-.25-1000 millihenries

Inductance measurements—chart reference:—

0-.25-100-1000-10,000 henries

Model 419P illustrated above in hand rubbed, natural finish maple case complete, ready to operate.....\$36.50

Model 419C, open face bench type with 4½" meter, in hard wood case.....\$34.50

Model 419V-7 with large 7¼" bakelite meter in upright black crackle steel case, 10½" x 19" x 5¼".....\$44.50

Other instruments in the complete line of R.C.P. electronic and electrical test instruments described in catalog No. 127. If you have an unusual test problem — either for production line or laboratory work — consult our engineering department.

RADIO CITY PRODUCTS COMPANY, INC.

127 WEST 26th STREET



NEW YORK CITY

MANUFACTURERS OF PRECISION ELECTRONIC LIMIT BRIDGES — VACUUM TUBE VOLTMETERS
— VOLT-OHM-MILLIAMMETERS — SIGNAL GENERATORS — ANALYZER UNITS — TUBE TESTERS
— MULTI-TESTERS — OSCILLOSCOPES — AND SPECIAL INSTRUMENTS BUILT TO SPECIFICATIONS

For the Creators of the New World of Electronics

— a new booklet which provides engineers and physicists with a convenient summary of the fundamental properties of nickel

NICKEL IN THE RADIO INDUSTRY

THE PROPERTIES OF PURE NICKEL

by E. M. WISE and R. H. SCHAEFER

Reprinted from
METALS AND ALLOYS
September, November and December, 1942

"The Properties of Pure Nickel," illustrated here, is a new booklet reprinted from a three-part article just published in "Metals and Alloys."

It supplements the previous publication entitled "Nickel in the Radio Industry."

Together these two publications provide engineers in the electronic field with the latest summary of information and data on nickel. They also include an extensive bibliography for use when a more detailed investigation of particular properties is required.

"The Properties of Pure Nickel" covers the physical, mechanical, electrical and other properties and constants of (1) very pure nickel, and (2) commercially pure "A" Nickel; it discusses (3) the effects produced by alloy additions of some other elements to low-carbon nickel made from commercial electrolytic nickel. The International Nickel Company, 67 Wall Street, New York, N. Y.

THE INTERNATIONAL NICKEL COMPANY, INC.
67 Wall Street, New York, N. Y.

Gentlemen:

Please send me copies of your publications:
"The Properties of Pure Nickel"
"Nickel in the Radio Industry"

Name _____ Title _____

Company _____

Address _____

E.I. 4-43

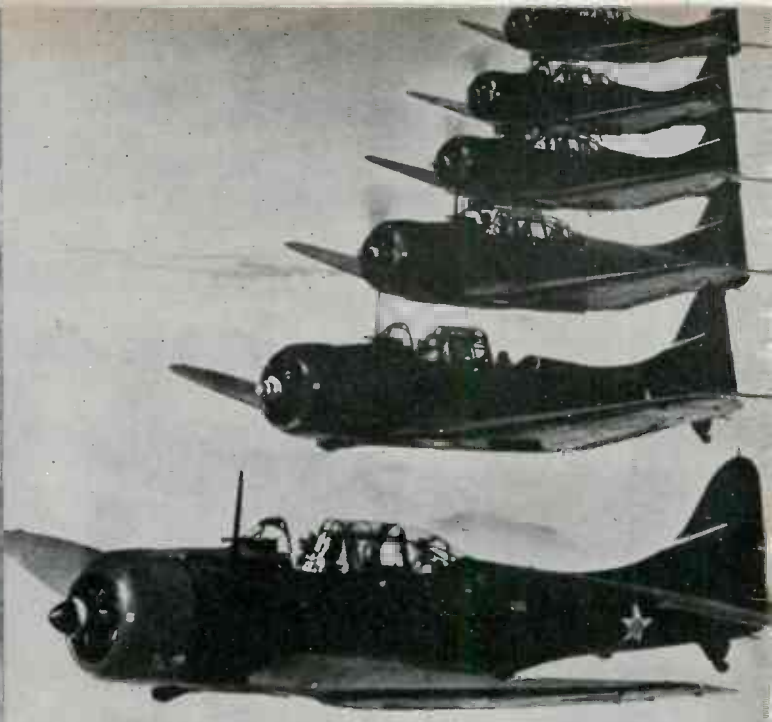
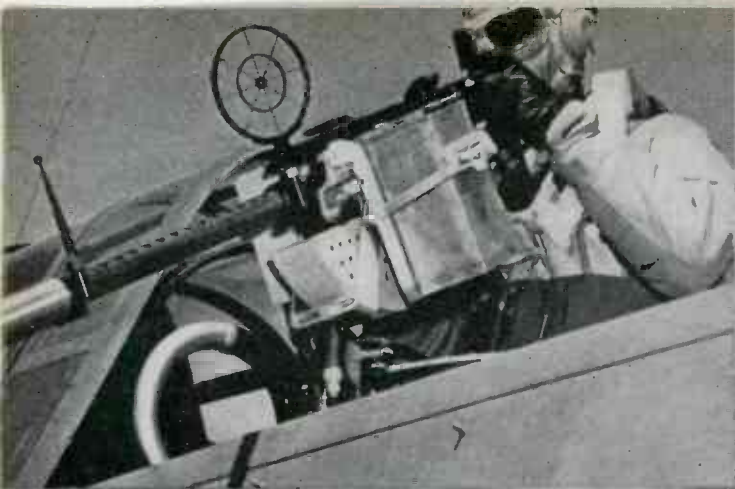

U. S. NAVY OFFICIAL PHOTOS

UTC CASE HISTORIES

Laboratory File No. S14-523



This unit helps "keep them flying." A UTC redesign combined two units in one . . . reduced quantity of critical materials 50% . . . reduced weight and size 40% . . . reduced installation time 60% . . . reduced possible trouble points 50%.

Laboratory File No. S14-312



This unit maintains ground communications at a more efficient level. Now plastic housed. Critical materials reduced 50%. UTC design reduced possible trouble points 50% . . . reduced difficulty of operation 50%.

Laboratory File No. T16-399



This unit is used at a number of points in aircraft communication. A UTC design reduced quantity of critical materials used 20% . . . reduced weight and size 20% . . . reduced possible trouble points 50%.

Laboratory File No. S9-474



This unit is a component in a piece of aircraft equipment. A UTC design reduced quantity of critical materials 60% . . . reduced weight and size 60% . . . made possible a similar reduction of size and weight in the complete equipment of which it is a component.

WHAT CAN WE DO FOR YOU?

UNITED TRANSFORMER CO.

150 VARICK STREET

NEW YORK, N. Y.

ELECTRONIC INDUSTRIES

O. H. CALDWELL, EDITOR

M. CLEMENTS, PUBLISHER

480 LEXINGTON AVE., NEW YORK, N. Y.

Technical "High Command"

One of the principles which "Electronic Industries" is promoting, as you may have noted, is the placing of executive responsibility in qualified engineers.

We feel that a "technical high command" is essential in business, as in military operations—that in the electronic field the executives who make the determining decisions must have full and expert knowledge of the behavior and possibilities of electronic devices. Without such expert understanding in the directing mind, certainly the operations of the whole organization are endangered under pressure of competition and economic strain. The same philosophy has also been discussed in detail in recent issues of "Fortune" and the "IRE Proceedings."

The rapid pace of electronic development and the difficulties which lay minds have in keeping up with the myriad new developments, are being illustrated every day. Our military and naval authorities have already recognized the new electronic techniques and have revolutionized their own fighting strategy. The same kind of technical high command must come, more and more, behind the lines, in our industrial plants.

Thorough electronic understanding is a requirement for future executive management.

The difficult we do at once, the impossible takes a little longer.—General H. H. Arnold.

Radio in Tropical Warfare

Word coming back from the tropical fighting fronts reveals the terrific conditions under which American radio equipment must operate. For, in the dank and humid tropics, shoes and clothing quickly disintegrate, matches won't light, tobacco turns into a soggy mold, guns rust in a few hours, and mechanical equipment becomes clogged with dirt and insects. Yet radios must work and keep on working.

And U.S. radio, coupled with U.S. resourcefulness, has outwitted even Japanese wile and treachery. Alert American soldiers on outpost duty often push ahead until they come within earshot contact with Jap forces seeking to break through in strength at some weak spot in the American line. Whereupon the Yankee scout, through his walkie-talkie, signals back to the men behind him, warning them to strengthen their defenses against an imminent attack.

Radio is a vital weapon in 1943 warfare.

The Little Man Who Wasn't There

Said the salesman-owner-president-chief engineer of a small manufacturing firm to one of our editors: "The trouble with the engineering societies and engineering magazines is that they only want to play with the Big Companies, when it comes to papers, articles and news. The little fellow hasn't got a chance."

We denied this on principle. And right then and there we cordially invited him to contribute some material for a forthcoming issue. He said he'd certainly try to find the time to do it for us. Weeks have gone by. But it hasn't arrived yet!

The pages of "Electronic Industries" are open to anyone who has something to say, something to show, or something to comment upon. If the "little man" isn't there often enough to suit him, it's only because he doesn't make the effort to supply us with pictures, information, diagrams, etc., of new electronic applications, new theoretical ideas and studies, and new techniques and methods on the production and assembly lines. "Electronic Industries" has a permanent "welcome" sign out, for any and all types of material that will interest radio-electronic engineers; it doesn't matter how "big" or "little" the fellow is who sends it in.

For a generation we have been living on the edge of a new world. We are only now beginning to realize it.

—Donald M. Nelson, Chairman WPB

Electronic Manufacturing Since Pearl Harbor!

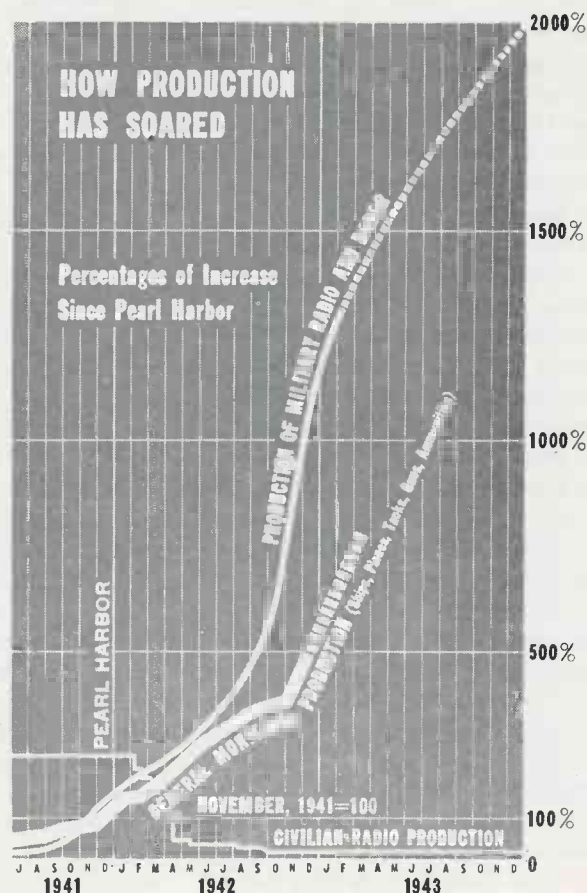



A session of the "board of strategy" of the Army-Navy Electronics Production Agency, to assign trouble-shooters

★ **Radio-Electronic WAR PRODUCTION**

How ANEPA Keeps

The Signal Corps has just issued a general report on the achievements of the Army-Navy Electronics Production Agency on the production fronts in keeping over four billion dollars worth of electronics equipment flowing steadily to vital war users.

ANEPA is the joint organization of Army and Navy officers and civilian specialists with long experience as engineers, radio technicians and industrialists. Its job is to keep production lines moving, remedy bottlenecks on materials and parts; in fact, to do anything and everything that is necessary to get the job completed on schedule.

ANEPA is charged with the responsibility of assisting contractors in all manufacturing phases of radio and related equipment that is being purchased by the War and Navy Departments. This embraces air-borne, ship-borne, ground, and vehicular equipment. In fact, it is charged with doing a huge job that not so long ago was thought impossible. Results have shown, however, that ANEPA is accomplishing

this gigantic task with increasing skill every day, and it has now rolled up an enviable record of results.

WPB's tribute

A recent report by WPB Chairman Donald M. Nelson stated that the production of radio equipment throughout the electronics industry had continued to increase and that the industry had shown a record percentage of gain over all previous months, and that the record had been greatly implemented by the efficient activities of Army and Navy.

As one example of its achievements, ANEPA had a recent urgent call requesting immediate shipment of a certain type of meters for installation in combat vehicle radio sets. These combat cars were due to be ready for a highly important unit embarking for overseas duty the next day. When it was found, unfortunately, that the type of meter needed was completely out of stock, ANEPA was informed. Although the time was late in the evening, ANEPA located the manu-

facturer of this type of meter in an Eastern State and dispatched a regional expediter to the plant.

There it was found that everyone had departed for the day except the plant manager, and further there were no stocks of that type of meter on hand. Acting quickly, the ANEPA expediter and the plant manager immediately contacted by telephone eighteen workers, all of whom came back to the plant to work through the night, with the result that by morning the meters were completed, inspected, packed, and on their way by fast express.

Production expediting

Up to August 27, 1941, the expediting of production was carried out by the commodity subsection of the Purchase Section of the Supply Division, Office of the Chief Signal Officer. Upon the recommendation of several civilian advisers to the Chief Signal Officer, a Production Expediting Section was established in August, 1941, in the Supply Division. By November.



George W. Parkin, ANEPA's chief production engineer

1941, the expediting section had continued to expand its activities to such an extent that it became necessary to divide the section into subsections in order to facilitate

Today, ANEPA is headed by a civilian Director, F. R. Lack, and two Associate Directors, one representing Army, the other Navy. The Director is also assisted by two Deputy Directors likewise representing the Army and Navy.

A well-organized regional set-up makes for efficient operation of ANEPA, with, for example, the Production Expediting Branch divided into three major groups, one for the East, one for the West and another headquarters staff in Washington. Eastern and Western Division region offices are located in Los Angeles, Chicago, Dayton, New York City, Philadelphia, and Boston.

Every region office has an officer in charge, a civilian district manager, office expeditors, field expeditors, and resident plant expeditors. The latter are attached to one plant where all contracts going through these plants are under their constant daily super-



Captain C. A. Rumble, U.S.N., deputy director and ranking military officer

Besides the highly-important Production Expediting Group are the Short-Range Materials Group, offering aid to prime and sub-contractors; the Wire and Cable

Electronic Production FLOWING

Army-Navy Electronic Production Agency has remedied bottlenecks resulting in record output

the handling of the multitude of details. With the tremendous increase in procurement of Signal Corps equipment, more changes were necessary by January 1, 1942, when it was decided to assign limited geographic sections to field expeditors and locate them at the nearest Signal Corps Procurement District office under the direction of a Central Expediter at the Washington Section. By mid-May 1942, the Region Office System, now in operation, was set up.

F. R. Lack, Director

The present Army-Navy Electronics Production Agency itself was formulated in August, 1942, after a series of conferences between Army and Navy officials.

vision. Field expeditors are concerned with several smaller plants in a particular region, while office expeditors work at the region office.

Group, spending its energies in the direction of keeping the Army and Navy wire and cable requirements running at an even keel; the In-

(Continued on page 134)



Expeditors meeting with C. E. Richardson, assistant chief production engineer

In the CHEMICAL

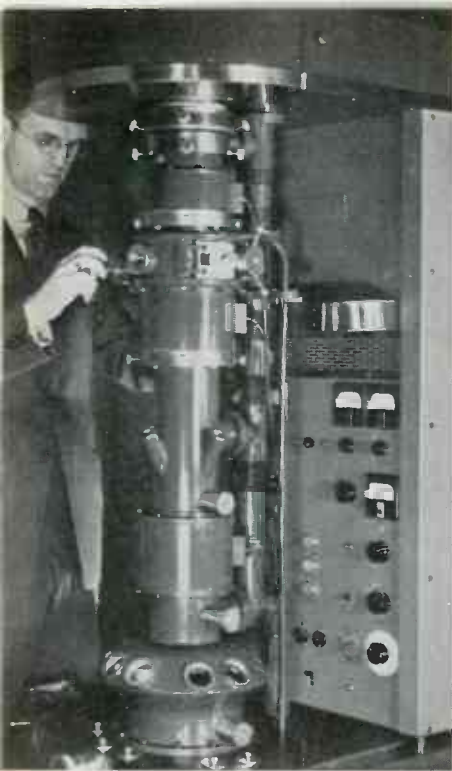

ELECTRON MICROSCOPE in research laboratories of Interchemical Corp., N. Y.

Those who are associated with the design and manufacture of the various types of tubes and component radio-electronic parts are quick to acknowledge the debt electronics owes to chemistry. Now, with the development of tube applications proceeding at an unprecedented pace, that debt is being repaid.

Electrochemical processes

The electrometallurgical reduction of aluminum and various electrochemical processes involving non-metallic substances require large blocks of direct current at voltages ranging from 250 to 1,000. Motor-generators were standard conversion equipment in this field for decades, but ignitron rectifying

units have been installed in very large numbers during the past five years.

Impetus for the trend towards rectifying equipment arose partly from material shortages. Copper and steel utilization in a typical 5,000-kw, 600-volt rectifier unit amounts to about 115,000 pounds. An equivalent motor-generator installation may require 180,000 pounds of copper and steel. However, the benefits of greater experience with mercury-arc equipment have resulted in other advantages over rotating converters. Higher efficiency, lower maintenance cost, wide-range stepless voltage control by phase-shifting in the ignitor circuit, and the ability to operate satisfactorily under heavy or overload conditions are a few points of superiority.

In the aluminum industry, the dependability of the ignitron is a most important factor. Failure of the continuous power-supply results in loss of vital wartime production and necessitates re-starting the plant, a difficult and expensive operation. With their reliability now well-established, ignitrons have become standard equipment in all major aluminum and magnesium plants.

Other war-chemicals

Electrochemical processes are involved also in the production of chlorine, caustic soda, hydrogen and sodium perchlorate. In addition to its well-known use in water-purification chlorine is employed in bleaching of textiles and paper, and as an essential element in rubber, plastics, and poison-gas manufacture. Sodium hydroxide, or caustic soda, one of the three basic industrial chemicals, is currently produced at a rate of better than 3,000 tons per day by electrolysis of salt. Many installations of ignitrons in new and expanded chemical process plants have consequently been made since the outbreak of war.

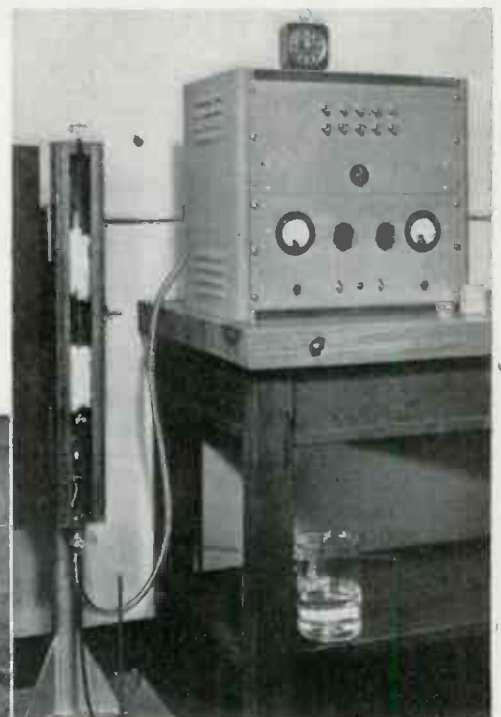

▲ **POTASSIUM** detection and measurement, by its radioactivity, with Geiger counter equipment used by American Cyanamid Company, Stamford, Connecticut

← **IGNITRON** rectifier installation in an Aluminum Company plant. Twelve banks of G-E 12-anode units provide total of 60,000 amps. at 645 volts. Master control-panel lower left, high-speed anode breakers along left wall, cathode breakers at extreme right



INDUSTRIES

by GILBERT SONBERGH

Electronic devices lower costs and speed production in reduction of aluminum and other products, in chemical analysis, electrostatic separation and precipitation



CHEMICAL COLORIMETER and → color grader made for Hercules Powder Co., Wilmington, Del., by Rubicon Co., Philadelphia. Single meter reading gives resin sample's ratio of transmission for light beams of two different colors

Studying physical structure

While the study of physical properties of elements and compounds might seem to be the exclusive business of the physicist, such is not the case. A number of recent advances in chemistry are the result of the utilization, in plant and laboratory, of electronic means of examination, measurement, and analysis, with the electron microscope, X-ray and electron diffraction equipment, and instruments measuring reflected, transmitted, or emitted light from various materials.

In the research laboratories of the American Cyanamid Company at Stamford, Conn., considerable work has been done on cellulose fibers. Cellulose is the base of many explosives. Among other important results of this work, use of the electron microscope has apparently settled a long-standing controversy concerning the existence of tiny particles or "bulbs" on the fibers. These are now regarded merely as an optical illusion introduced by the examination of the filaments with the light microscope. Diffraction rings are set up by the crossing points of two or more fibers. They are not seen in an electron-micrograph.

In order to facilitate comparison of equal-magnification photographs from the electron and light microscopes, American Cyanamid, using the first commercial electron microscope, developed a method of "bridging the gap" between the two types of instruments. By using

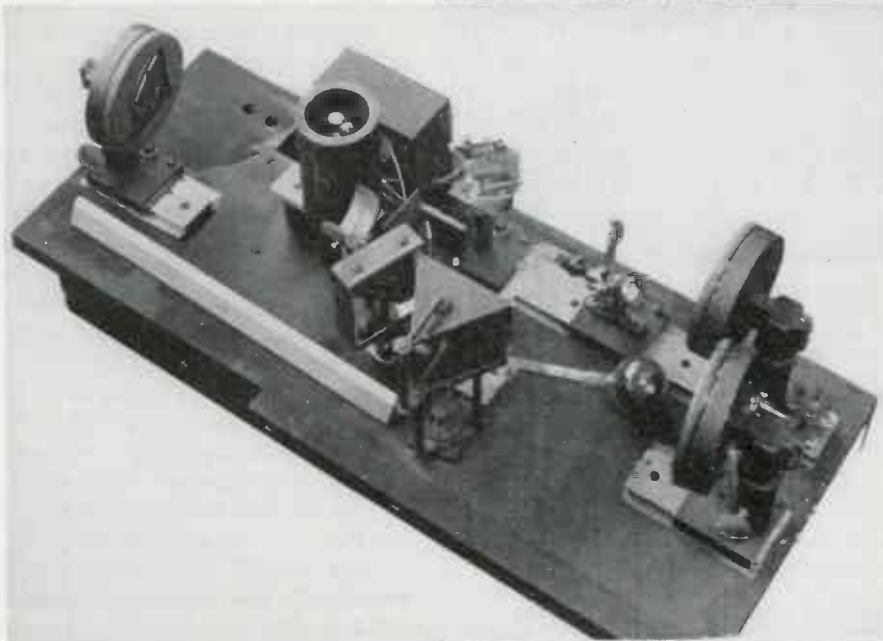

INFRA-RED spectrometer built by Porocel Corporation for American Cyanamid research laboratories, for spectral study of hydrocarbon mixtures. Graph at right shows per cent transmission vs. wavelength for a resin sample

specimen holders of various lengths, convenient manipulation of the electron microscope down to magnifications of 500 X or less was obtained.

In addition, a positive means of measuring the magnification was developed. A diffraction grating—a ruled reflecting surface which does the work of a prism wherever a precision light-spectrum is required—having 30,000 lines per inch is used. With collodion or Formvar, a thin, transparent nega-

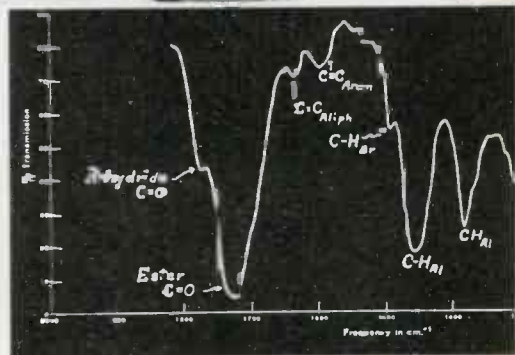

tive replica of the ruled surface is prepared and mounted on a 200-mesh wire screen specimen support, for examination in the electron microscope. Since the number of lines per inch of the diffraction grating is easily determined by spectral methods, the result is a

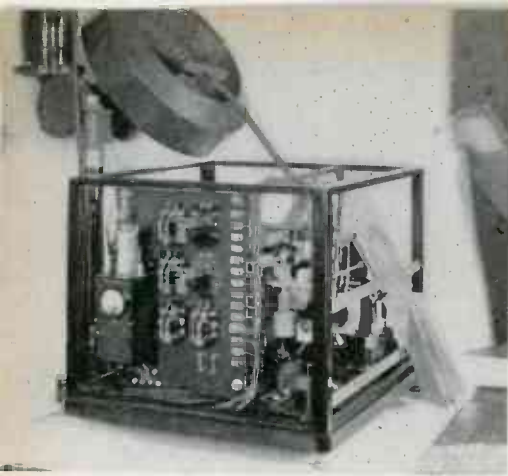

▲ **WEIGHING** and sorting small pellets automatically is accomplished by photoelectric means in this Toledo Scale Company unit, to accuracy of $\frac{1}{4}$ grain. Many applications of continuous weighing serve for powders, solids, and liquids. P-E amplifier is type 10, used on ne

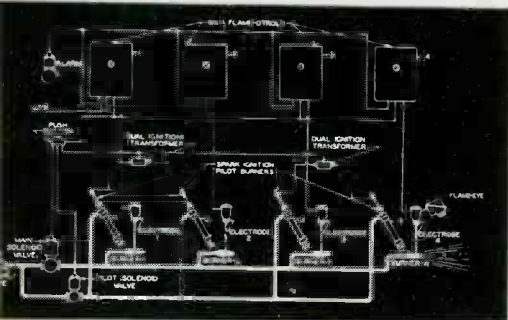

▲ **EXPLOSION** safeguards diagrammed for 4-burner oven or furnace. Electrode contacts flame to maintain grid voltage on tube which has fuel solenoid valve in plate circuit. No-flame or short cuts off fuel. Phototube (flame-eye) is alternative or additional safeguard in this system, engineered by Wheelco Instrument Co., Chicago, Ill.

SEPARATION of zircon from rutile aluminum oxide from silicon carbide, graphite from mica, etc., is accomplished quickly and economically by electrostatic equipment. Sutton, Steele, & Steele, Inc., Dallas, Texas, unit shown uses 4 STSs to supply 20,000 volts at .2 milliamper.

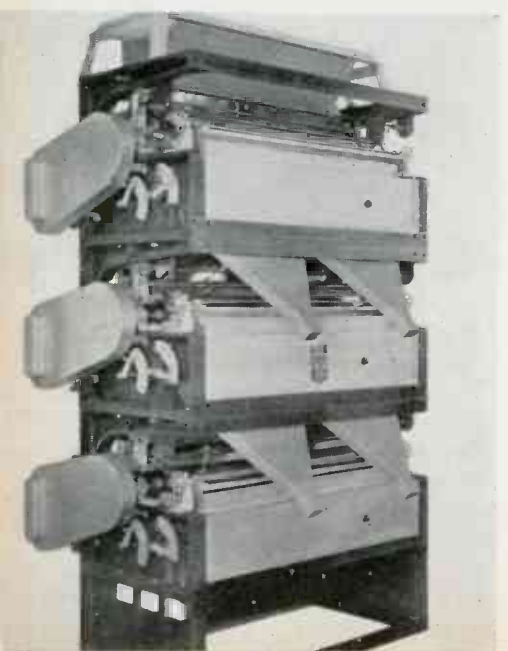

convenient "foot-rule" for the degree of magnification on the fluorescent screen or photographic film in the electron microscope.

New insight into the crystalline structure of matter is afforded by X-ray diffraction equipment, and by attachments to existing electron microscopes which enable taking of diffraction pattern pictures. Considerable aid has been given to research in the natural, reclaimed, and synthetic rubber fields. Diffraction patterns, the "fingerprints" of crystalline substances, are adding daily to the accumulation of knowledge in nearly every chemical industry.

Color in chemistry

Study, measurement, and control of chemical processes by light-analysis of chemical compounds usually involves some sort of photoelectric quantitative analysis of ultra-violet, visible, or infra-red light reflected from, passed through, or emitted by a hot sample.

The simplest type of equipment for such use is the colorimeter, or colorgrader. Basically, such a device consists of a phototube, a stage or two of dc amplification, and a millimeter. Provision for interposing a test-tube containing the chemical solution, between the phototube and whatever source of light may be employed, allows comparison of the light transmission with that of some standardized color filter or sample of liquid, gas, or solid, as the case may be.

Although all wavelengths of white, u-v, or infra-red light may be allowed to affect the photocathode, certain facts concerning the solution's composition can be determined, particularly if only one chemical variable is involved.

Spectrochemical analysis

Vastly greater usefulness is obtained from photoelectric light-transmission study if the device incorporates means for progressive analysis of the transmission of light of different wavelengths. Usually, automatic recording of the percentage transmission at each wavelength is provided.

Different elements and compounds and varying molecular

structure absorb certain wavelengths of light in the u-v and i-r regions in the same way that "coloring pigments" absorb certain portions of the visible spectrum. With known absorption-transmission (or absorption-reflection) ratios established, rapid analysis of chemical characteristics of a compound is made by comparing recorded spectral responses.

Infra-red or other light spectroscopy has two basic advantages over standard physiochemical and other methods of analysis. The first, from an economic standpoint, is speed. In many instances, spectrographic analysis can be performed in minutes instead of hours. The second, of inestimable laboratory value, is its high degree of accuracy when only minute traces of a chemical constituent are to be detected and measured.

Synthetic rubber control

An experimental infra-red spectrometer developed by the American Cyanamid Company for analysis and control of hydrocarbon mixtures involved in the production of synthetic rubber illustrates the possibilities of such equipment. Infra-red light is split up by means of a large salt-crystal prism and directed, by a system of mirrors and apertures, through the sample (gaseous in this case) to a thermocouple or infra-red phototube. The prism is motor-driven through suitable reduction gearing for continuously varying the i-r wavelength of the beam passed through the sample.

The output of the tube or thermocouple is amplified to a suitable level, and operates a galvanometer or inking recorder. If automatic control were desired, the absorption cell could be fed continuously from a small by-pass in the production line and suitable solenoid valves in the line operated by the amplifier in response to changes in the gas passing through.

Other spectrographic units

Another type of spectrographic analysis widely used in the chemical industries provides extremely rapid quantitative analysis of any known or unknown material. A very small sample of the material

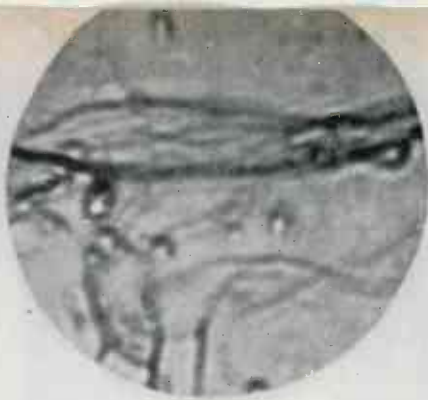
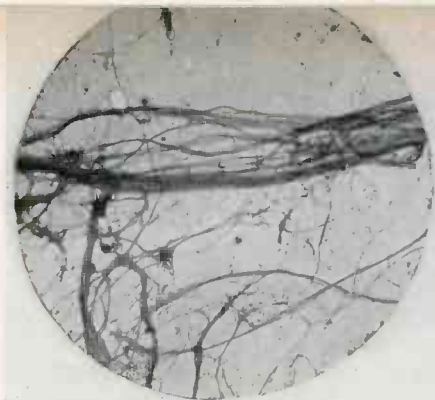

COMPARISON of photomicrograph (at right) and electromicrograph (about 2,000 X) of the same field of mechanically disintegrated cellulose, to prove diffraction disks (bubbles, or "particles") merely effect of light microscope

ELECTRONMICROGRAPH of activated charcoal on American Cyanamid's diffraction-grating replica to show use of grating as internal magnification scale

to be analyzed is evaporated or "burned" in an arc-gap. The material is sometimes in the form of a small pellet, sometimes intermixed with the material of the electrodes themselves. The gap is excited with dc, ac, or high-frequency ac, and the light emitted is analyzed into a spectrum, usually by a reflecting diffraction grating instead of a prism. This spectrum is recorded on a photographic film or plate of as near equal sensitivity to all wavelengths as the state of the photochemical art permits.

Comparison of the spectrogram thus obtained with a "master" spectrogram which consists of spectra of the known elements, serves to identify the composition of the material under test and gives a rough idea of the proportions in which various elements, wanted and unwanted, may be pres-

ent. Accurate quantitative data are then obtained by taking a densitometric reading of the spectral lines on the film. Lines resulting from the electrode material itself are easily identified and left out of the accounting. The densitometer used consists, in its simplest form, of a mixed light source, either with electronic voltage control or some other means of insuring stability, an optical system for passing a thin slice of light through the spectrogram lines, a stabilized phototube and an amplifier operating a recorder or galvanometer, whose deflection, of course, is proportional to the relative densities of the deposits of silver in the lines. Several such instruments are available commercially.

Another type of spectrographic equipment is the Hardy recording-spectrophotometer, built by Gen-

eral Electric and well-known as an instrument for analysis and specification of color. Operating in the visible range, this device is generally used to measure reflection, rather than transmission, at the various wavelengths, and its users in industry are more concerned with color as such than with chemical analysis of materials. To some extent, however, it can be used in determination of chemical properties as a function of light absorption-reflection ratios. The research laboratories of the Interchemical Corp., N. Y., have employed the spectrophotometer both ways, in study of pigments and vehicles for inks, paints, and other protective and decorative coatings.

Additional methods of detection and measurement of unknown chemical properties depend on re-
(Continued on page 136)

TEMPERATURE control of rotary cement kiln of Lawrence Portland Cement Co., Northampton, Pa. Phototube holder and optical system on standard to left of center in photo. This G-E pyrometer unit has double-chart recorder, amplifying equipment, and speed control contactors mounted in panel



SPECTROGRAPHIC analysis is simplified by automatic equipment for scanning and recording densities of spectrogram lines of unknown material. Unit shown made by Leeds & Northrup, Philadelphia, Pa.

MILITARY VEHICLE

Program



HALF TRACK, one of many types of military vehicles. Besides being completely radio-equipped, power plants and chassis of most such trucks involve numerous applications of electronics in their production. Photo by Signal Corps, Ft. Monmouth, N. J.

ROCKER-ARM action under "slow motion" study with Gen'l Radio Strobolux



Applications of electronic devices to the manufacture of trucks and other military vehicles are conveniently divided into three categories: Studies in research laboratories through performance and other tests; laboratory and production-line tests and spot checks of various components; and production methods directly or indirectly utilizing electronics.

Design research

Typical laboratory applications are the cathode ray tube, the stroboscope, X-ray diffraction analysis, and various methods of indicating

and measuring, through vacuum-tube amplification, surface irregularities of bearings, gears, and other parts.

Cathode ray oscillographic analysis of fast or complex mechanical actions, vibrations, and combustion chamber pressures is of infinitely more value than any older methods of study. In measuring combustion or detonation pressures, previous methods at best gave only an average curve representing the time vs. pressure relationship. The cathode ray oscillograph can provide a curve for each power stroke, and has demonstrated that many variations may exist.

Equipment used consists generally of special quartz crystal pickups inserted in the test cylinder, a voltage amplifier, some sort of horizontal amplifier to provide the time-base, and the oscillograph. The time-base is generally secured from the engine rotation itself in order to provide a uniform oscillogram at various speeds.

Pickups of the magnetic type may be used if an integrating amplifier is incorporated to maintain voltage output as a function of pressure despite varying engine speed.

An interesting combination of the oscillograph with stroboscopic equip-

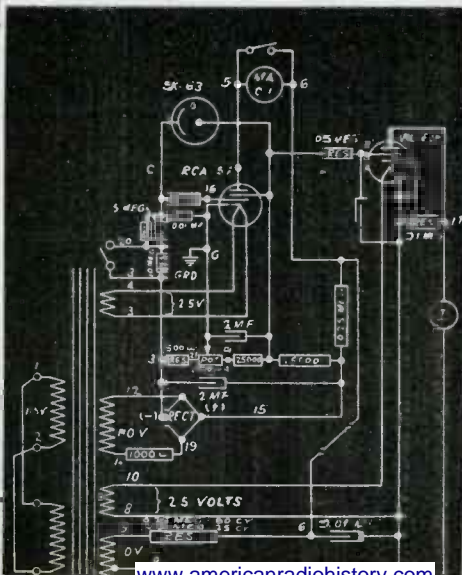

PHOTOELECTRICALLY controlled ACF resistance heater automatically delivers small stock hot, ready for upsetting. Left, schematic of Westinghouse control unit

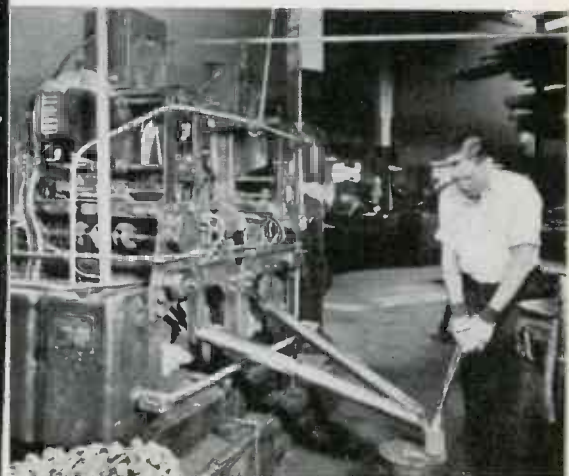



VALVE-MECHANISM testing setup, in Mack Truck Company laboratory, using stroboscope and cathode ray oscillograph



TORSIONAL VIBRATION study, to measure and analyze twisting effects of power strokes on crankshafts

ment for study of camshaft, lifter, and valve action is used by the Mack Manufacturing Corporation. A dummy engine is driven by a small electric motor, direct-coupled to the engine's camshaft. Between the motor and the camshaft is a flywheel graduated in degrees, and a small pulley which drives the dummy engine's timer through a belt arrangement. The timer triggers a General Radio stroboscopic unit, and its speed differs from the camshaft's speed by a few rpm to allow stroboscopic observation of a complete valve-cycle in about ten seconds at high engine speed.

The strobotac light source is mounted above the graduated flywheel so that the exact position of the cam is known at all times, and the more powerful strobolux unit flashes on the valves, lifters, and cams. Thus, any false motion of the lifters in not following the cams, etc., may be observed and measured.

At the same time, an actual valve-lift curve on the cathode-ray screen is obtained. One of the valves mounts a small magnetic pickup. Since its output varies with changes in the velocity of its armature, an integrating amplifier (visible at left of oscillograph in illustration) is incorporated.

Vibration analysis

All types of vibrations are easily studied by electronic methods. As a typical example, the Mack set-up illustrated uses Sperry vibration measuring equipment, consisting of pickup, calibrator, wave analyzer, integrating amplifier, and recording oscillographs. The torsional vibration pickup is mounted, in this case, in the space normally provided for

the cranking jaw at the front of the engine. The engine is run and the vibration, or variations in angular velocity represented by varying output of the pickup, is recorded on the oscillograph. There are several methods of securing a basis for comparison and interpretation of this variation. A very heavy flywheel may be mounted on the free end of the engine crankshaft or other shaft under test and the speed of rotation of this end assumed to be constant throughout each revolution, in which case some sort of time base is secured from the oscillograph's own sweep circuit, from an external ac voltage, or from movement of film in a recording oscillograph. An ac generator may be coupled to the free end of the shaft, in which case it is assumed that its speed and output are uniform. The correctness of such assumptions is immaterial, since the result is concerned only with the difference in angular velocity between one end of the shaft and the other.

Other vibration study with oscillographic equipment includes all types of stray vibrations in engines and mounts, as well as in other



TIMING spark with neon stroboscope

parts of the truck or vehicle. Stroboscopic equipment allows on-the-spot visual study of vibrations and other cyclic phenomena and has been particularly useful in analysis of valve-spring surge and oil throw-off from crankshafts, bearings, and other parts.

Other applications of electronic methods in the automotive laboratory include: X-ray and X-ray diffraction studies of metals before and after fabrication and of various parts after destruction in tests or breakage in use; polished surface analyses with crystal or magnetic pickups, voltage and power amplification, and moving-pen or other recording; and several schemes for fine measurement, as with the Fellows involute gear measuring machine.

Sound-level meters, recorders, and analyzers have many uses in laboratory studies of design and performance of automotive engines. Strain gages — with pickups of quartz, resistance wire, or magnetic construction—are used with indicating or recording oscillographs.

Various interrelated engine operations are timed with electronic

ELECTRONIC AIDS TO PRODUCTION

- Cathode ray analysis of motions**
- Stroboscope studies of cyclic phenomena**
- Photoelectric temperature control**
- Sound and RF noise measurement**
- Timing related engine functions**
- Dynamic balancing of crankshafts**
- Electrical components tests**
- Flat and curved surface analysis**

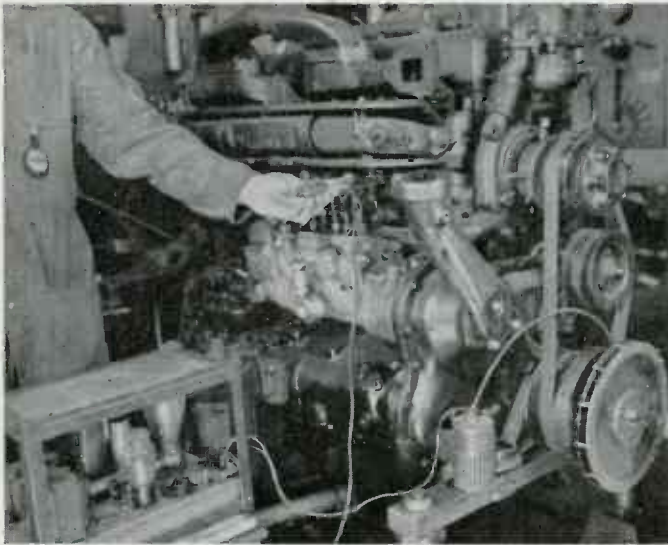

PICK-UP, thyratrons, coil, and neon indicator near fly-wheel time start and duration of injection in Diesel engine



ELECTRONIC coil tester in Cities Service laboratory

equipment. Stroboscopic apparatus, using mercury-vapor or neon tubes as the flashing lamp, has long been in use for ignition timing. Typically, the spark from a particular plug is made to operate a neon indicator, which is held close enough to the engine's flywheel to illuminate inscribed graduations as they pass a fixed metal pointer.

A high power timing lamp has been designed by the Cities Service Oil Company's Research Division to satisfy the industry's demand for a more intense flash of light of very short duration. The lamp is neon-filled, of spiral shape, and is mounted behind a curved Lucite rod to enable the light to be conveniently directed into difficult locations. A conventional power-pack charges a condenser through a series resistor. A cold-cathode gas-filled four-element tube is used to trigger the discharge of the condenser through the high power lamp, in response to a control voltage taken directly from a particular spark plug.

Parts tests

Another Cities Service device tests ignition coils by discharging a charged condenser through the primary. The discharge is triggered by a strobotron tube at a frequency of 3600 times per minute, in response to a 60 cycle voltage source. The performance of the coil is studied by noting the length of spark jump in air, appearance of discharge, etc. A small neon bulb

parallels the spark gap to indicate any "misses." This electronic interrupter does away with erratic behavior common to mechanical systems.

In ignition-type engines the number of sparks per minute is, of course, directly related to engine rpm. Another device used by Cities Service is so arranged that a gas-filled tube is triggered by the ignition spark. The output is fed through a measuring circuit to a moving coil meter calibrated directly in engine rpm. The instrument is self-regulated, so that no compensation for variations in line voltage is required.

Noise in many types of trucks is checked, on the production line, with standard sound-level meters. The instrument is used to determine amounts of noise produced by transmissions and various other components.

With modern military strategy and tactics so dependent on fool-proof radio communication, the radio-frequency noise level of trucks and other military vehicles equipped with or used near radio apparatus, must be kept low.

Standard procedure in some plants is to check each truck before delivery, using ordinary high fre-

(Continued on page 139)

MOTOR CONTROL, applied to arc-welding equipment used in fabrication of automotive axle-housings. Electrode is fed at pre-set rate





With Army and Navy now collaborating in many operations, as in the North African landing here pictured, it becomes of the utmost importance that radio equipment be interchangeable between the two services

ARMY-NAVY TUBE "SPECS"

Joint document specifies 288 types

After nearly a year's preparation, the Signal Corps and the Bureau of Ships have issued for the first time a "Joint Army-Navy Specification for Radio Electron Tubes." Some 288 types of receiving tubes, transmitting tubes, rectifier tubes, photo tubes, cathode ray tubes and voltage and current regulators, are included in the first issue of this new specification.

This new specification, which bears the issue letters JAN-1, was originally begun under the auspices of the Army-Navy Munitions Board and then carried to completion independently by the two services. Representatives of all major tube manufacturers have worked closely with the Armed Forces in drawing up this new specification.

Some idea of the magnitude of the work may be seen from the physical size of the specification which is a looseleaf bound book nearly two inches thick. It is expected that few additional tubes will be added to the joint specification by the Bureau of Ships and the Signal Corps Standards Agency in the near future, since efforts are being made by both Armed Services to restrict to a short preferred list the number of tube types being used in communications and electronic equipment because of the tremendous replacement and stocking problems which have arisen in

the field through lack of standardization.

While inapplicable to current contracts, the new specification will govern all future tube production. All technical problems relating to the new specification are being handled by a joint Army-Navy working group which has been set up to keep the specification up to date.

Governs future production

Specification JAN-1 has two main parts, one outlining the tests and requirements and the other consisting of a series of sheets giving the test limits for individual tubes. The tests have been divided into type approval tests, design tests and production tests and the necessary requirements and sampling for each test have been clearly outlined in the new specification in order to avoid confusion.

Four samples of tubes having a list price in excess of \$10 or six samples of tubes having a list price of \$10 or less will be required by the government agencies for joint type approval tests except in special cases. In addition, photographs and test data for the sample tubes will have to be submitted with all tubes submitted for type approval. This test data will be used by the Armed Forces to provide a degree of assurance that submitted tubes

will pass type approval tests and to provide a check on the accuracy and adequacy of the test equipment of the various tube manufacturers.

Tubes to be marked

As evidence of the securing of type approval, all tubes manufactured under this specification will be marked with the designation JAN followed by the manufacturer's code letters as signed by the Services and the commercial type number or the Army or Navy type number if there is no commercial designation for the particular tube.

Tubes bought by the Armed Services from manufacturers whose type approval tests have not been completed will have the manufacturer's code designation omitted. Design tests will be conducted on one per cent but not less than five tubes of any one type in one production lot, while life tests will be conducted on production samples as specified for the particular tubes.

Severe vibration, bump and salt-spray corrosion tests are included under this specification in addition to the customary tests for electron tubes. Another point of interest in the new specification is the standardization of shields used in measuring inter-electrode capacitances of tubes having various types of bulbs.

FACTORY

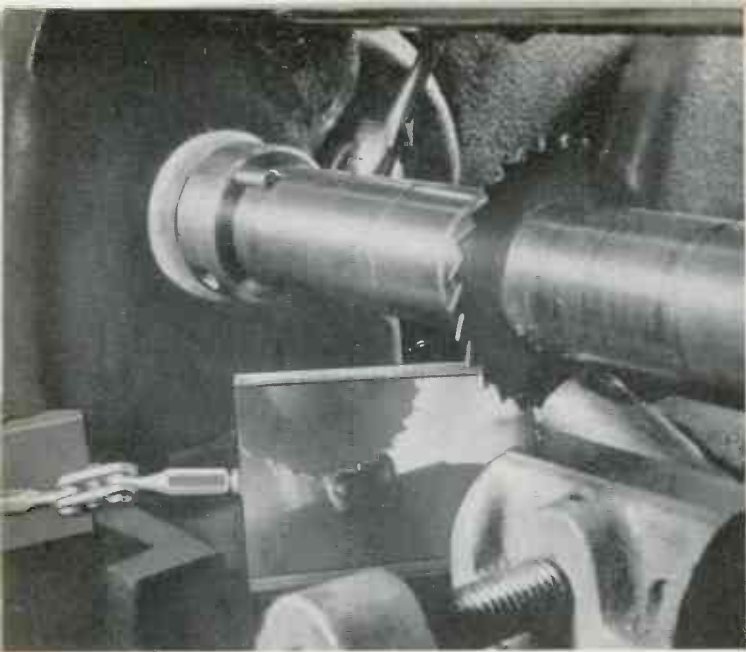

TWO VIEWS AT ONCE of same piece of work insure better results and speed production on milling machine or other factory operation. Small permanent magnet holds mirror unit made by Ullmann Products Corp., Brooklyn, New York

Combatting Absenteeism

A number of manufacturers have used an effective, graphic method of bringing home to the workers the importance of their production, as a preventive against absenteeism. A large chart is posted on the bulletin board in each department. Detachable cardboard symbols picture the product manufactured.

Every day, a sufficient number of the symbols are affixed to show the quantities of tubes, condensers, or what-have-you, that were lost to the Allied Nations forever, due to absenteeism the day before.

In one plant, the names of workers A.W.O.L. are posted.

In another, union leaders and fellow-workers themselves look in-

to the matter of a worker's absence, particularly if he "has the habit." These same workers set up a quick din of boos and catcalls when an employee comes in late. It works in one case, but problems of tardiness and absenteeism are often so specialized that careful thought must be given to plant conditions in order to work out satisfactory solutions.

Who Said "Handicapped"?

In many cases, the employment of blind, deaf, or otherwise handicapped persons is more than a short-cut around the manpower problem. Many factory operations are better performed by the lame, the halt, and the blind.

A Chicago metal-working concern was awarded a Navy contract



SPECIAL SOLDERING IRONS made to fit a particular job often speed work. Right-angle iron shown in use at Weston, Newark, N. J., plant

PRECISE LATHE WORK is facilitated by using neon lamp to signal contact of tool with work. In G-E plant, scheme eliminates human visual element and allows working within accuracies of .00005 inch. With equipment marketed by United Cinephone, Torrington, Conn., contacts mounted on lathe bed and rest actuate signal through an amplifier tube, on only three microamperes contact current

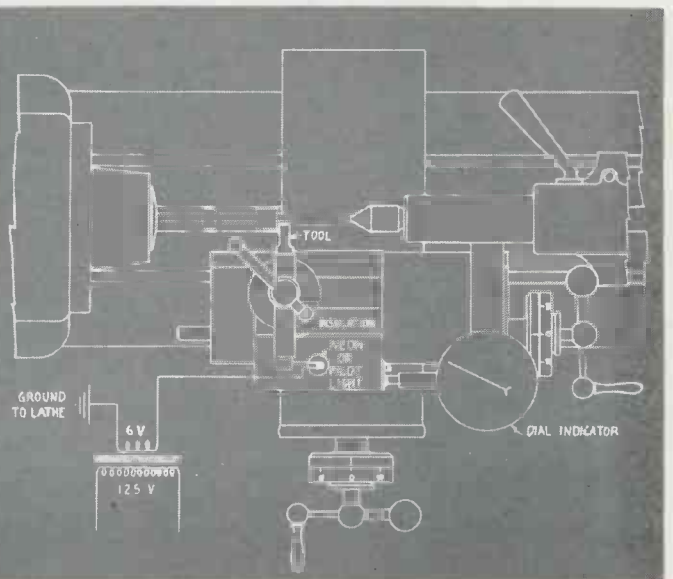

SHORT CUTS

which involved the use of the ear-splitting air-hammer. The firm employed, through the United States Employment Service, five deaf mutes as a test and checked their performance against that of seven normal men. Result: All the normal men are to be moved to some other task as soon as sufficient deaf workers can be hired.



GLANCE SHOWS SITUATION in production and materials programs at Emerson Radio plant in New York. Production board made by Wassell Organization, Westport, Conn., here gives due-dates of all materials, shows which are behind schedule and which are coming in on time



SAFETY FOR X-RAY WORKERS is provided by bit of film clipped to vest. Developed each week, film reveals whether worker is receiving dangerous amount of radiation. Idea comes from Westinghouse X-ray tube test department

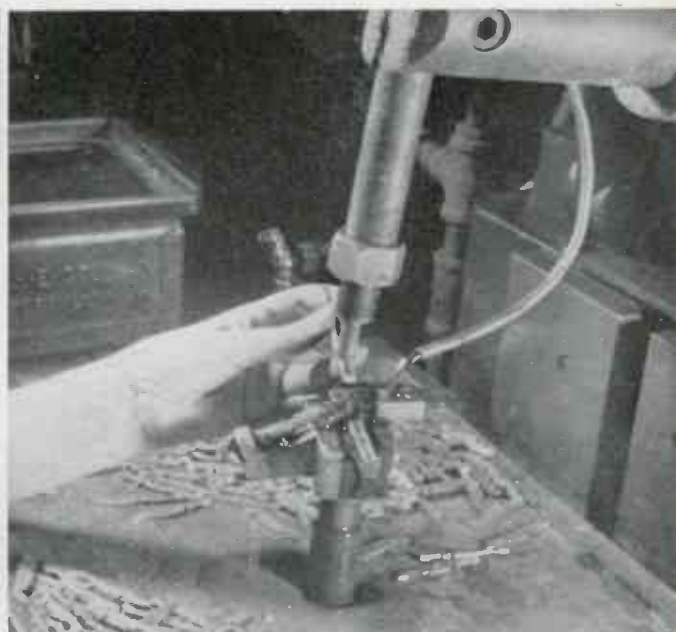

UNDERWATER WELDING results in faster production and better quality resistance welds, as well as saving in electrodes. Continuous stream of water plays across entire fixture in this set-up at Westinghouse plant

In general, the handicapped are excellent workers wherever they are used. Because work they are placed at is carefully analyzed beforehand to determine whether they have or can learn the necessary skills, they are usually physically and mentally happy.

Untangling Welding Cables

Where a number of welding machines are in use at the same time and place, operators sometimes waste time tracing their cables back to their own welder, for adjusting or trouble-shooting. If

each cable is identified with similar number or name tags at each end, taking a hint from color-coding in electronic devices, all such trouble is eliminated.

Effective Help-Wanted Ads

Apparently, two biggest present-day problems are personnel and materials. At National Union, Newark, N. J., the problem is to find enough girl-workers. Ed DeNike, director of advertising and publicity, tried display advertising without results. Next experiment was

to "humanize" classified ads, make them interesting reading, and base appeal on patriotic and love-motives; response to the ads has been up to two or three times greater than from ordinary help-wanted space.

The "story" is featured, not the name of the company. The fine results may be due in part to cumulative effect of the appeals; many girls mentioned that they had followed the advertising before applying for work. When possible, DeNike uses two-column width. The most effective and the most recent ads are reproduced on page 132.

SHRINKAGE in RESISTOR MANUFACTURING

Effect of humidity in cutting output of units requiring close tolerances. Air-conditioning expected to raise production

Today when shortages exist in materials and labor, every avenue of possible saving must be investigated to find ways by which production can be increased and made more efficient.

Army and Navy specifications are putting new demands on produc-

Ellis, director, and S. K. Wolf, in charge of components—has been conducting a survey of the resistor industry. Conclusions from this survey indicate that manufacturing shrinkage in fixed composition resistors is much higher than is the case with other types of resistors. This is mainly due to kinds of materials used, to the effect of close Army and Navy tolerances, to moisture problems in the production line, to the need for protection against "moisture pick-up" once the resistor is made, and probably also to the need for more care of electrical test equipment when the weather is humid.

% Tolerance	% Yield
20	89
10	50.5
5	33.5

At first glance one would assume that this decrease is entirely due to the severity of the new tolerances. If such were the case the problem of shrinkage reduction in fixed composition resistors would be quite simple.

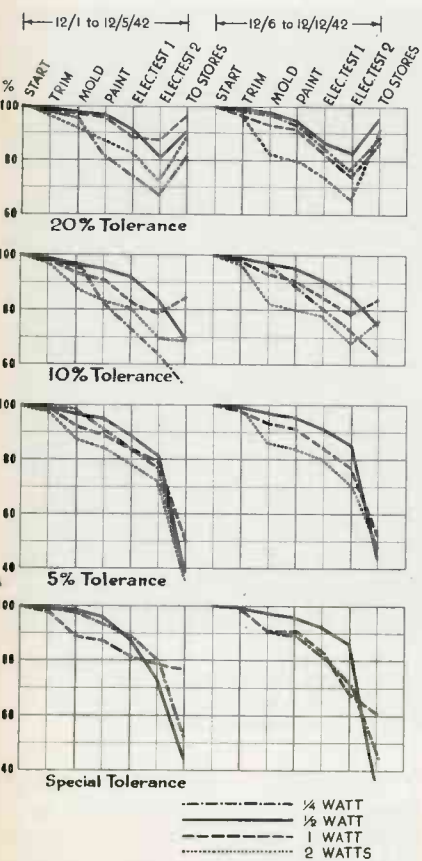

Shrinkage for fixed composition resistors. Tests covered two separate periods as shown, different resistor groups being separately recorded

Narrower tolerances

Today the old +20 to -20 per cent tolerance has been succeeded by +10 to -10 per cent tolerance, +5 to -5 per cent tolerance, the +2 to -2 per cent tolerance and many varieties of special tolerances. The majority of electronic resistors now have to meet the 5 or 10 per cent tolerance.

Data from the resistor industry indicate that, in dry weather (December 1942) the shrinkage or yield of fixed composition resistors is about as follows for resistors from 1/4 to 2 watt size.

% Tolerance	% Yield
20	90
10	75
5	45
2	20

Actual data are shown in charts accompanying. Statistical analysis of these data, covering 1/4 and 1/2-watt types, shows that fixed composition resistors from the same source, of the same type and produced in dry weather, will follow the yield pattern given here:

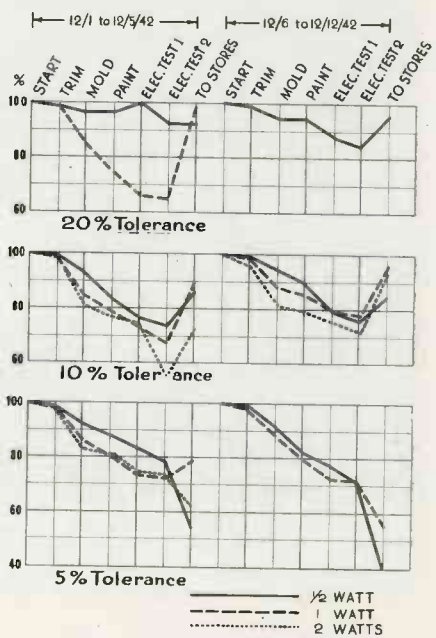

Wire-wound resistor shrinkage, at various tolerance requirements. Performance of various rating groups shown by coded lines in graphs

But the WPB survey has shown quite conclusively that yield for any tolerance is always higher in dry weather and low in humid months. One manufacturer had records that showed high yield in specially dry weather, while two companies, who have used air conditioning in the summer months for their mold rooms over several years, state that they would be forced to shut down for from 3 to 4

tion lines, and in meeting these severe requirements, some unexpected factors have been found to affect production results to a surprising degree.

Recently the Radio Division of the War Production Board—under the general supervision of Ray C.

months each summer without humidity control. Furthermore some of the large manufacturers who make capacitors (which, in the fixed composition field, require much the same materials as resistors) use moisture elimination methods throughout capacitor production. These facts would be sufficient to indicate the need for the introduction of moisture-elimination methods.

Results of moisture

But there is other evidence. Most composition resistors are made of powdered resistance materials (often metallic in structure) with a phenolic binder. It has long been an established fact that low relative humidity and high insulation resistance are definitely related. For example, in the telephone field, a controlled low relative humidity was found to increase the average insulation resistance of toll telephone cable from 900 to 2700 megohms per mile.

Furthermore the phenolic binder introduces "case hardening" problems which add to the problems of the resistance materials. The reasons for these marked differences are due to the effect of relative humidity on dielectric materials. These differences include porosity, structure of the material and the tendency of such materials to case harden. The relative humidity effect on moisture content of insulating materials can be visualized through data compiled by Urguhart & Williams on cotton regain shown in accompanying curve. In addition Rutan, while discussing insulating materials, stated that their required chemical properties included resistance to moisture. He pointed out that surface leakage can be augmented by surface moisture and also that, in porous materials, or those containing appreciable moisture, the volume resistivity decreases. "Surface insulation resistance is dependent upon the conducting power of a thin film of moisture on the surface of the insulating material."

The seriousness of the case-hardening problem with phenolic materials has been pointed out by technical representatives of both the Bakelite and Durez Companies who emphasize the need of drying

phenolic materials on receipt and state that, if phenolic compounds enter the mold with a moisture content, nothing can be done to remove the moisture.

"Relative humidity"

What is this thing called relative humidity? As air is heated it expands. Conversely when it cools it contracts. As air expands, its ability to hold moisture increases and as it contracts its ability to hold moisture decreases. Therefore air at a high relative humidity, when cooled sufficiently, will lose some of its moisture content by this squeezing process. In the outside atmosphere this means rain, snow, hail, sleet or fog. By the cooling process air-conditioning equipment removes excessive moisture and then reheats the air to obtain the desired humid, or moisture, content. The relation between the amount of moisture in the air and the amount of moisture which that air "could hold," is known as the per cent of relative humidity.

An alternative method of humidity control exists which consists of removing moisture from the air by means of silica-gel. In this case two or more silica-gel tanks or containers must be used. When one "bed" of silica-gel becomes saturated with moisture it must be removed from the "line" and reactivated into dry silica-gel by means of heat. In the meantime a second tank or container of silica-gel is introduced in the air circuit. Another method consists of passing the air over dessicators containing calcium chloride, lithium chloride or some similar drying agent.

Therefore the maintenance of a fairly low relative humidity, during the production of fixed composition resistors, would affect the results of electrical tests on resistors and would improve yields for composition resistors of the fixed type under severe tolerances.

Dry materials

Careful consideration of the production process and the application of a fixed relative humidity, will quickly lead to the conclusion that the materials entering the mold must be dry, the molding process must be under a controlled humidity, the molded resistor must be protected against regain of moisture by the application of some type of insulation and the electrical testing equipment could very well be located in a controlled atmosphere.

The fact that most electronic fixed-composition resistors carry 5 or 10 per cent tolerance very definitely limits the overall yield in dry weather to 50 per cent. In humid weather a yield of 35 per cent is very likely to result. The waste, in either case, of labor and materials is entirely beyond reason. Comparisons with wire-wound resistors of small sizes indicate that wire-wound yields are between 5 and 10 per cent better than yields for the same sizes in fixed composition resistors (see charts).

The questions naturally arise as to (1) how much improvement can be obtained through control of the relative humidity and (2) what per cent of relative humidity should be used. A glance at the shrinkage, or

(Continued on page 134)

Effect of relative humidity on cotton regain, from data compiled by Messrs. Urguhart and Williams

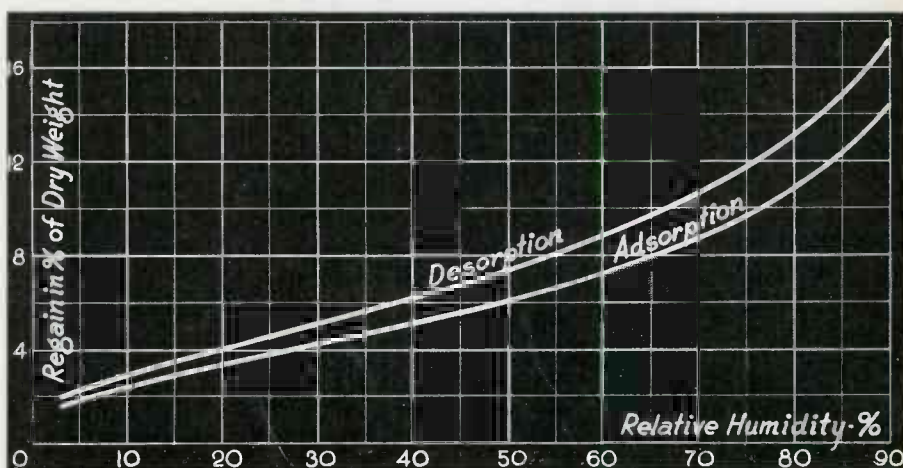

The CATHODE RAY OSCIL

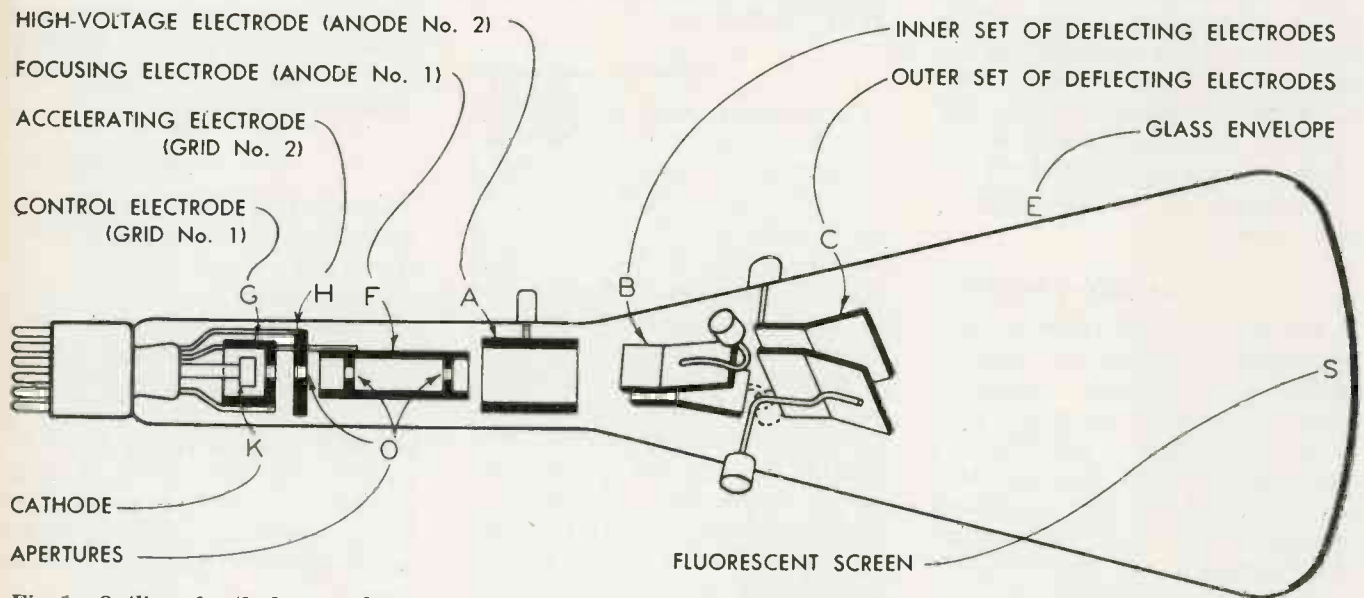

Fig. 1. Outline of cathode ray tube

It has been said that most of the most important scientific advances of the twentieth century have been based on principles dealing with the movements of electrons in evacuated space. Most of these applications have depended on the control of the amount of electricity, determined by the speed and density of the electron movement inside of the vacuum tube. All the ordinary radio tubes: diodes, triodes, pentodes, etc., fall into this classification.

A cathode ray tube uses another electronic principle: that of controlling the direction of the electron's movement. It finds its principal application in the field of measurements and in television. This tube might be thought of as a "meter" that has no moving parts except a jet of electrons which acts as a "pointer" that is free to move in either or both of two directions. It can therefore delineate the resultant of two movements such as the variation of one electrical quantity with respect to another, and can follow those movements so rapidly that it can be used at frequencies of many megacycles per sec.

Fool proof

Besides its use in an oscillograph it can also serve in replacing simpler instruments, such as voltmeters and ammeters. It is practi-

cally fool proof in spite of its appearance, since the deflection circuit cannot be overloaded. Overloads that would destroy an ordinary instrument have no deleterious effect on the cathode-ray tube.

Terms defined

An oscillograph is a term applied to a device that draws a graph of an oscillation. The oscillation is usually that of an electrical current (or voltage). A picture of an alternating current wave with respect to "time" would therefore be an "oscillogram." Such a graph showing relative effects must be, therefore, a two dimensional picture—"time" being represented by horizontal distances and "voltage" or "current" values by vertical distances.

An oscillogram also refers to the delineation of any electrical effect with respect to any other electrical effect: such as the relation of current to voltage, impedance to frequency, and many similar conditions. The process has been extended to refer to the delineation of pictures of the variations of non-electrical factors as well. In some descriptions the term "oscilloscope" refers to identical equipment, since certain writers reserve the term "oscillograph" for equipment that makes a permanent record of the oscillogram.

Cathode ray tube construction

All tubes of the heated-cathode class include a source of electrons—the cathode (K), and a high voltage electrode or anode (A) to attract these electrons and to give them an axial velocity along the tube. This anode also is associated with auxiliary accelerating and focusing electrodes (H) and (F) which provide means for focusing these electrons into a fine jet. (3) means for deflecting the jet or ray so as to make it useful in recording. (4) the fluorescent SCREEN that makes the point of impact of the ray visible. Electrons and their movements are normally invisible. To render the effects of the movements visible to the eye the inner surface of the screen is coated with a fluorescent material that glows whenever and wherever the ray impinges. Items (K), (G), (H), (F) and (A) are collectively known as the ELECTRON GUN. Control grid (G) is used to vary the intensity of the ray. The layout of these parts in a typical tube is shown in Fig. 1. Item (H) is omitted in some tubes.

Classifications

Cathode ray tubes may be classified in several ways, such as:
—by size. This is the most obvious and general of all classifications.

LOGGRAPH in INDUSTRY

by R. R. BATCHER

Consulting Editor, Electronic Industries

See also large chart in colors (sent as supplement with this issue) showing applications of cathode ray tube

The most important dimension is the screen diameter.

—by screen fluorescent characteristics. Different materials that are used have different colors, different light intensities, etc.

—by deflection arrangement. Most tubes are equipped with electrostatic deflection plates mounted within the tube but a few are arranged so that they need external magnetic deflection coils only.

—by the focusing method. There are three main types here: gas-focused, magnetically focused, and electrostatic lens focusing. Only the latter type are used in oscillographs.

Complete oscillograph

Oscillograph requirements in hundreds of diverse fields of application have provided manufacturers with a definite knowledge of what features any oscillograph must provide. The first need, of course as with all other types of electronic devices, is the power unit, to supply all of the necessary voltages. The next is a pair of deflection amplifiers which can be connected in at will, to provide increased voltage sensitivity of the deflection plates in both horizontal and vertical directions. Another "must" is a linear time base, to provide the horizontal movement of the ray, when any particular conditions are to be analyzed with respect to time. Apparatus that supplies this latter feature is referred to in the field by various designations, such as a saw-tooth oscillator, sweep circuit, timing oscillator, time base, and in television applications, a scanning oscillator. All of these terms represent the same apparatus: the means for producing a known base deflection. This means for timing an oscillogram is needed since there is nothing in the cathode ray tube itself that is capable of indicating or recording time intervals.

In a typical oscillograph, such as the model pictured in the center of the chart sent as a supplement with this issue, all of the above items are permanently installed in one unit and connected to switches for easy manipulation. **For the vast majority of applications in industry no additional equipment will be needed.** As shown in the chart some auxiliary equipment and certain accessories are convenient, and sometimes necessary, in certain specific tests.

Electron switch

General items include an Electron Switch, which permits two (or more) oscillograms to be superposed simultaneously and with correct phasing for direct comparison. Typical oscillograms taken with an electron switch are shown in the chart. In some tests a linear time base which will operate at some extremely low or high frequency will permit certain tests to be more accurately analyzed.

The same holds true with other tests, at frequencies below 30 cycles or above 100kc, where deflection amplifiers that are efficient at those frequencies must be used. Then again, some tests are more easily studied when a Circular Time Base is used, so that successive recurrences of a condition are shown in "polar" form. An audio frequency oscillator having a good waveform, and a simple resistance-capacitance phase shifting circuit will

provide the circular trace, as in Fig. 2. The chart also shows other auxiliary items that are often effective in oscillographic tests of a specialized nature.

In quite another class, there are certain devices that are known as "Accessories." These are of particular utility in industrial work. An oscillograph handles and illustrates variations in electrical potentials, (or on occasion, magnetic field variations). The Chart, therefore, shows several common accessories which are used to convert mechanical movements, sound, vibrations, light sources, and other conditions into the electrical potentials needed to produce the oscillogram. These units are the well-known vibration pickups, microphones, photocells, magnetic field search coils, etc.

Camera recording

Since a cathode-ray oscillograph will record such extremely rapid variations, the eye cannot follow or analyze many kinds of oscillograms directly. A camera (with fixed or continuously moving film) is used to provide a record that can be analyzed at one's leisure. Certain other accessories shown are sometimes convenient to provide a deflection calibration in terms of voltage, phase, current, frequency, pressure, etc. Of these the simplest type, a transparent scale marked with appropriate divisions will per-

Fig. 2. Method of producing a circular time base

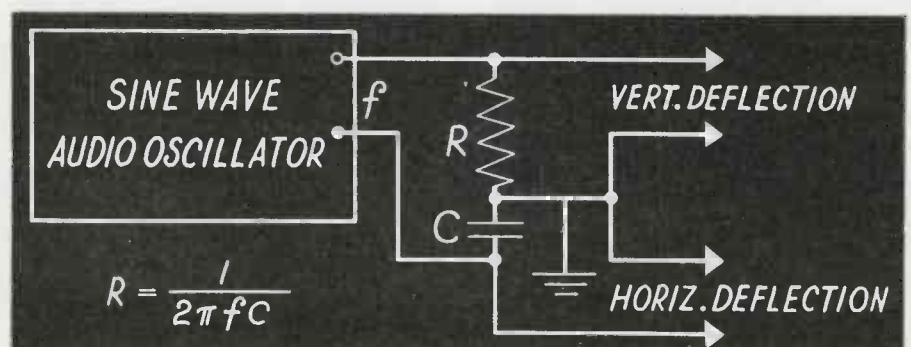

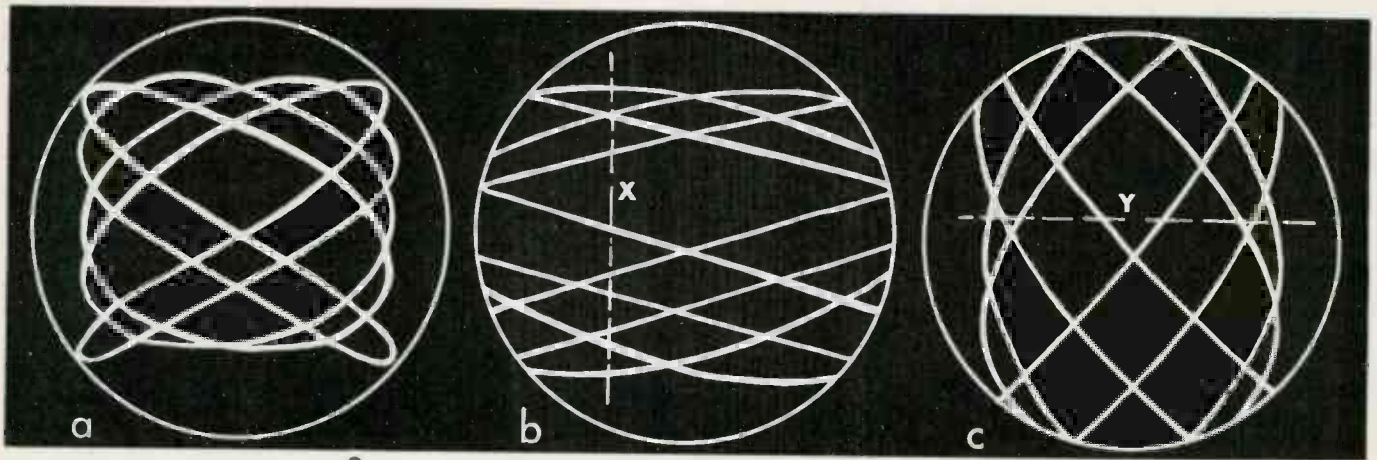

Fig. 3. Analyzing Lissajou figures

mit the deflection to be analyzed in terms of linear movements that permit calibration.

Sometimes a source of standard frequencies, as from a tuning fork, or a suitable electron tube oscillator, will provide a time axis having known characteristics. The use of such an oscillator for a circular time base has been mentioned. It will also provide a sinusoidal time base, which is basic for Lissajou figures. A specialized oscillator of this type is commonly used in servicing radio receivers, to permit all tuned circuit adjustments to be made in a manner so as to obtain resonance characteristics that are required for quality of reception.

Modulation of cathode ray

All cathode ray tubes are provided with an intensity control grid, whereby the brilliance of the spot can be adjusted at will. This feature provides the fundamental feature in television application of cathode ray tubes. A number of the deluxe types of oscillograph have a modulation amplifier permanently connected to this grid, whereby the starting or stopping of some factor under test causes the intensity of the trace to be instantly altered. This feature, sometimes known as Z axis control, is valuable in providing a simple and accurate time scale in what might be a complicated type of oscillogram. The spot is deflected in the usual way but at definite intervals the brilliance is momentarily blocked out. What results is an interrupted line with gap spaces arranged at known intervals.

Typical commercial tests

In any research or industrial test problem, when effects are found that cannot be stated by a simple reading from an electrical instrument, a complete statement of the conditions can only be expressed as a curve. These are the effects that are best analyzed with a cathode ray oscillograph. There are hundreds of actual applications in research testing. A few typical uses will illustrate this versatility.

Analysis of Musical Tones. The study of pitch, timing, tonal quality, and volume are visually delineated as an aid to instruction. A singer cannot hear his own voice accurately, but can become acquainted with the visual equivalents of the various effects and in this way practice control. The oscillogram also shows the form and amount of distortion present, when the music, etc. is transmitted by an audio amplifier system.

Ballistics. In the investigation of the momentary pressures associated with artillery firing, recoil forces, speed of the projectile, and in other tests, an oscillograph is a standard item of experimentation. Numerous styles of vibration converters or pickups are available for this work.

Broadcast Station Modulation. In all major broadcasting stations, a cathode ray oscillograph is continually available to check the per cent modulation. At the same time it shows the carrier level, the existence of abnormal distortion, and other effects. Here the vertical deflection plates are connected to a small antenna or a tuned circuit,

loosely coupled to the radiated field of the transmitter. The audio modulation frequencies applied to the transmitter are also connected to the horizontal deflection system. The resulting diagram is in the trapezoidal form oscillogram #10 on the chart. From this diagram the per cent modulation is indicated by measurements made on the diagram appearing on the screen of the oscillograph.

Engine Cylinder Pressures. Piezo electric pressure converters or similar devices are applied to the cylinder in a steam or gas engine so as to be actuated by the internal pressure. These devices generate electric potentials proportional to the pressure or to the rate of change of the pressure. Such potentials are amplified and applied to the vertical deflection plates. The horizontal deflection is controlled by the rotation of the machine. The typical oscillograms are shown on the chart.

Electron Tube Tests. The rapid delineation of the characteristic operating curves of an electron tube sometimes assists in speeding up inspection tests. With suitable switching, many superposed characteristic curves are shown in a second, each being a record of some set of operating conditions and all being made consecutively.

Hysteresis Curves. These curves show the relation between the magnetization forces (H) and the resulting flux (B) in a magnetic material when the former is produced by alternating currents. The vertical deflection can be produced by the flux from the specimen itself,

while the horizontal deflection is an alternating potential applied synchronously with that used to produce the magnetizing field to the specimen.

Ignition Tests for Gas Engines. Testing the efficiency of the spark plugs and other parts of the ignition circuit, timing studies, etc., provides important information as to engine economy. Other effects such as studies of the efficiency of interference suppressors, breaker gap spacing, condenser values, have also been made.

Frequency comparisons

When two waves that are essentially sinusoidal are applied to a cathode ray tube deflection system, Lissajou figures result. If the frequencies are steady and bear simple ratios (represented by low order integers) to each other, the diagram can be analyzed as to the exact ratio by simple inspection.

Many lists of pictures have been published showing some of the simpler forms, but the writer finds that such comparisons are tedious and inconclusive, especially since the usual diagram obtained is not identical with those depicted. A simple rule however is to stretch the Lissajou figure, Fig. 3a, in the horizontal direction by opening up the deflection amplifier gain control so that it extends beyond the edge of the tube—Fig. 3b.

Count the number of horizontal lines that cross a vertical line as at "x" that is marked anywhere on the sketch. (Take note of points where two lines intersect and count both.) Next restore horizontal gain and extend the vertical deflection in a similar way Fig 3c. Now count the lines that intersect a horizontal reference line "y". The ratio of these two counts is equal to the ratio of frequencies: that is frequency connected to vert. plate: frequency connected to the horizontal plate = line count with vertical gain expanded: line count with horizontal gain expanded.

Radio Direction Finders. A visual delineation of the resultant of two signals picked up on two crossed loops points out the direction of incoming signals, static, etc. This application has received much attention in England. The tube can record radio echoes, where the

For a graphic presentation of the many uses of the cathode-ray tube, characteristic patterns, etc., see also large chart in colors

THE CATHODE-RAY OSCILLOGRAPH

sent as supplement with this issue

signal bounces back from ionospheric levels above the earth.

Medical Analysis. The muscular activity of the heart generates electrical potentials of one or two millivolts. These potentials are picked up by electrodes strapped against the skin, and (amplified) are applied to the cathode ray tube. The horizontal deflection is proportional to time. The resulting waveform assists in the diagnosis of heart disorders. Such apparatus is known as an Electrocardiograph.

Vibration in machinery. Piezoelectric and other forms of pressure

converts give the intensity of any vibration in a machine and so assist in the location of any abnormal eccentricity. The time base, for these studies must be controlled accurately by the movement of the machine under test so that the position of this unbalance can be determined.

SUPER-REGENERATION RE-DISCOVERED

Though invention is both varied and complex, inventors are of two general types—the theorist who envisions a goal and steers for it and he whose practical ability produces a system first and the theory afterward. This is the conclusion of Edwin H. Armstrong, interviewed by T. R. Kennedy, Jr., well-known radio writer of the N. Y. Times.

Oddly, Major Armstrong exemplifies both. As an inventor, Major Armstrong is perhaps one of the few men who have produced something new, failed to recognize it, then had the good fortune to reproduce it again and recognize it as a new principle, years later, before the march of progress caught up. The tale became known for the first time when the American Institute of Electrical Engineers awarded him the 1942 Edison medal for outstanding radio work. Had Major Armstrong kept the tale to himself the world might never have known.

Began in 1915

The sequence of events began back in 1915 when he published a paper on the principle of "regeneration." Among the many circuits shown was a super-regenerative one, which Major Armstrong had used but not recognized as such, and although the paper was reprinted in many languages all over the world no one else recognized it either. Then came 1920. Priority

(Continued on page 144)

Syphilis Germ Revealed

Originally photographed at 54,000 diameters by the electron microscope, here is an unpublished picture of *treponema pallidum* which causes human syphilis. Wavelengths of light are shown on same scale. Photo taken by Dr. Katherine Polevitsky, University of Pennsylvania, and Dr. T. F. Anderson, RCA Fellow, Natl Research Council

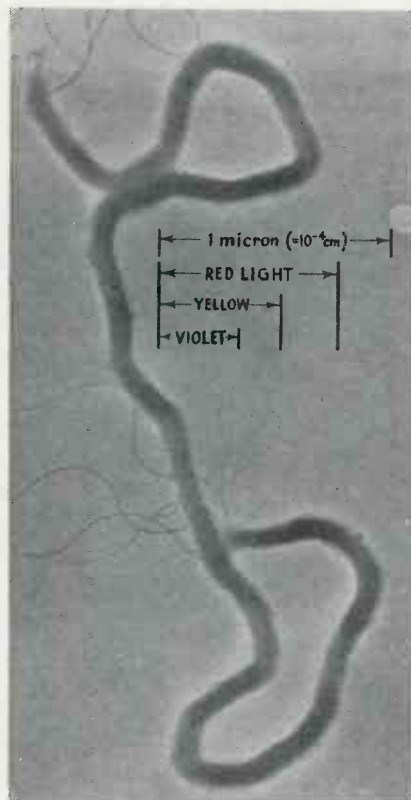

The TELEPHONE STEPPING SWITCH in Electronic Applications

by C. J. DORR & L. N. GALTON*

American Automatic Electric Sales Company

Many engineers designing electronic devices have found themselves sometimes faced with situations in which, apparently, there was no other way to do a job than to use large numbers of relays—so many that the devices became impractical from the standpoints of size, cost, and maintenance; so many, too, that what had started out to be an electronic device ended up by looking like anything but that!

Today more and more engineers are finding that automatic telephony has produced a simple solution to such problems. It is called the stepping switch. Actually, it is a relay which, instead of having two, has many positions. With this switch, common circuits can be transferred, one at a time, to many secondary circuits, with the number of such circuits almost unlimited.

Typical stepping switches are shown in Fig. 1. As in a relay, the

switch has a coil and an armature; unlike the relay, however, the armature does not actuate contact springs mechanically by means of an arm, but instead its arm rotates a ratchet-wheel and shaft. On the wheel and shaft unit, there are a number of wipers so arranged that they sweep over a semi-circular bank of contacts, touching each of them in turn. The switch illustrated is arranged so that the wipers rotate in one direction only; as one end of the wiper leaves the end of the bank, the other end of the wiper steps on to the beginning of the bank. Thus, continuing impulses repeat the successive contacting cycle.

Effective, simple

The simplicity and effectiveness of the switch can best be illustrated by a typical case in which, if desired, either relays or the switch might be used to accomplish a desired action.

Let's say that you have a problem in which you want to select any one of 20 circuit paths—a situation often encountered in remote control of radio transmitters. Fig. 2 shows how a 25-point rotary switch with 3 control relays will do the job.

Closure of the impulsing device K operates relay A, which in turn operates relay B. Subsequent closely spaced short interruptions of the impulsing device's contacts produce similar pulsations of relay A. Relay B however is slow-release and so does not release on these short circuit-openings. The rotary magnet RM is then impulsed from back contacts on the A relay through make contacts on the B relay. Simultaneously, relay C is energized in parallel with the rotary magnet, and, being slow release, holds its contact open during the pulsing sequence. Power is thus removed from the control level of the rotary switch.

As soon as the impulsing sequence is concluded, as indicated by permanent closing of the impulsing device's contacts, the C relay releases and the desired controlled circuit is energized. Release is accomplished by opening the impulsing device's contacts. The rotary magnet is then energized from power at the contacts of relay A, through the homing level and the interrupter contacts on the rotary magnet. It then generates its own impulses to restore the switch to the home position, where the homing circuit is opened at the home contact of the homing level.

Such switches are used in four broad types of situations: selection, distribution, counting, and totalizing.

*A companion article on "Telephone Relays in Electronic Applications" by the same authors, appeared in "Electronic Industries" for March, Page 68.

Fig. 1. The 11 point rotary switch

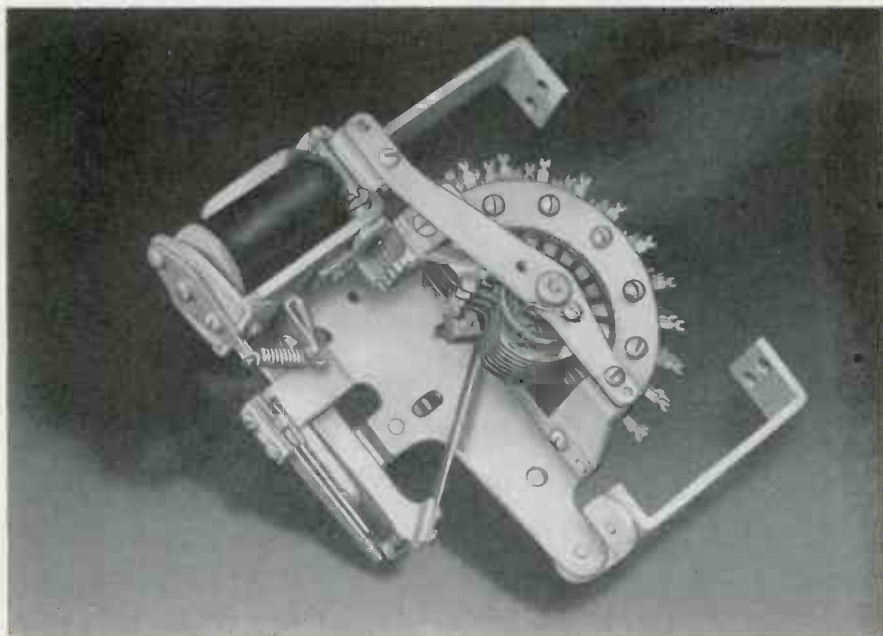

Selection

Selection is most commonly employed in remote-control functions when a number of things must be performed over a minimum of wires, usually two. Selection is often used in conjunction with electronic equipment as, for example, in the previously mentioned radio transmitters. The typical circuit arrangement was shown in Fig. 2, where individual controlled circuits are selected at will by means of the impulsing device, usually a telephone-type dial. Where the control is over extremely long distances, it is sometimes desirable to use audio frequencies generated by electronic equipment from the impulse source. At the receiving end, these tone impulses operate another electron tube, in the plate circuit of which is the line relay (relay A in Fig. 2).

In this circuit a separate bank of contacts is used (homing level) which is wired in groups so as to advance the switch around to the starting position. The switch will stop at any point where the jumper wire is left off that particular point on the homing level contacts.

Distribution

Distribution is, in reality, automatic selection. In automatic telephony, for example, a certain number of trunks or links are used to

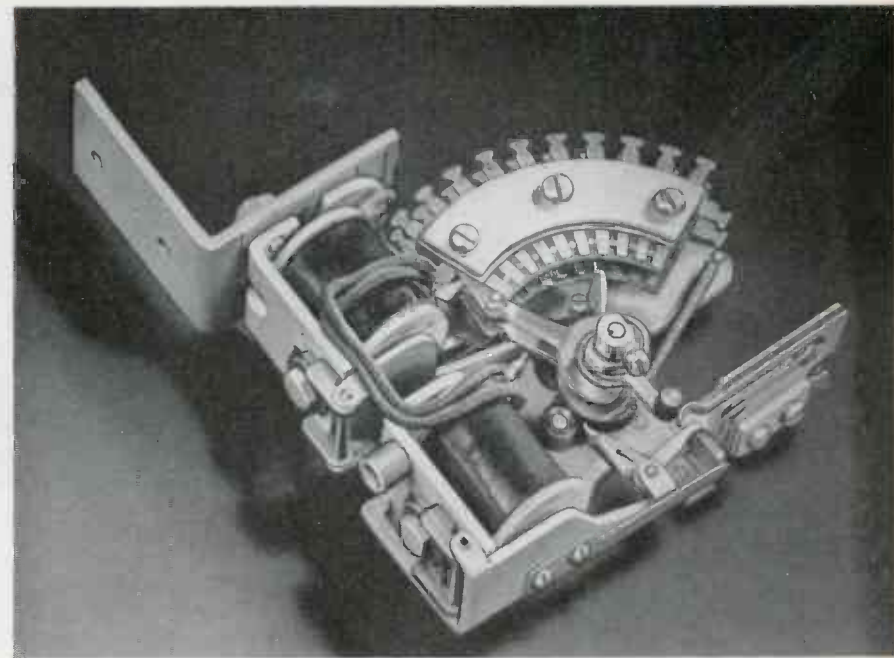

Fig. 3. The minor switch which uses separate rotary and release magnets

serve every 100 telephones. To make a call, you must obtain a trunk line or link (signified by "dial tone"), after which you may dial through to the called line. Now some haphazard arrangement could be used, of course, to enable you to find any idle trunk. Such haphazard assignment, however, would mean that a few of the links would do most of the work. Therefore, to avoid unequal assignment where even distribution of traffic is desirable, a mechanism is used which

automatically assigns the links in sequence. A busy link is, of course, skipped, but on the whole all links carry approximately the same amount of traffic.

Such distribution arrangements often serve useful purposes in non-telephone applications. One example is the switching of a conveyor successively from one bin to another in a factory. Or again, the successive performance of various operations by complex machine tools. In the common automatic turret lathe or screw machine, for instance, various operations are performed in sequence and the cycle automatically repeated. Here distribution is accomplished mechanically. In the sequence welder the control discussed in the first article was accomplished with relays, primarily because the number of steps was low. However, when the number of steps is high (5 or more), the rotary switch becomes very adaptable.

A typical distribution scheme employing a stepping switch is shown in Fig. 4.

Various functions

Operation of the start key will step the switch from the normal position, whereupon subsequent closures of this switch or of the leads (A) across it will advance the switch one step at a time. The A leads can be controlled by the con-

Fig. 2. Circuit using stepping switch to effect various controls

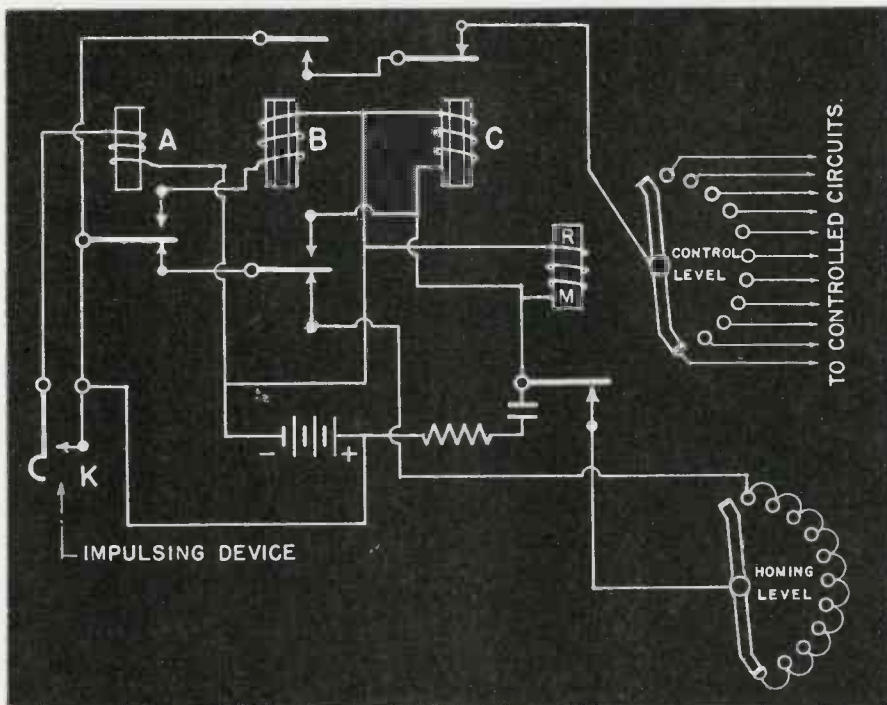

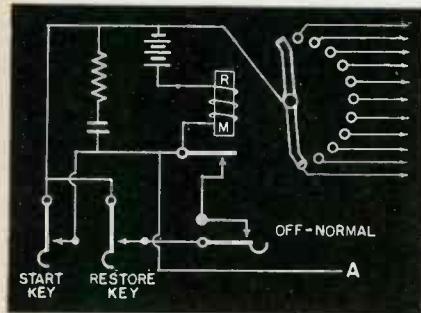

Fig. 4. Typical distribution scheme

tacts on the machine or device itself. The operation of the restore key will close the magnet circuit through the OFF-NORMAL springs on the stepping switch. This causes the switch to step around immediately to the starting position. These cam-operated off-normal contacts may be seen at the bottom of Fig. 3.

In Fig. 4 the contacts on the switch are connected to various functions to be controlled as for example on a machine-tool setup, or a pre-set series of test conditions.

Counting

Counting is one of the most common electronic applications of stepping switches. In practically every manufacturing operation it is desirable to have some counting means. Ordinary mechanical counters are a familiar sight. In many cases, however, automatic reset or variable group counting is necessary,

Fig. 5. Circuit for counting in groups and units

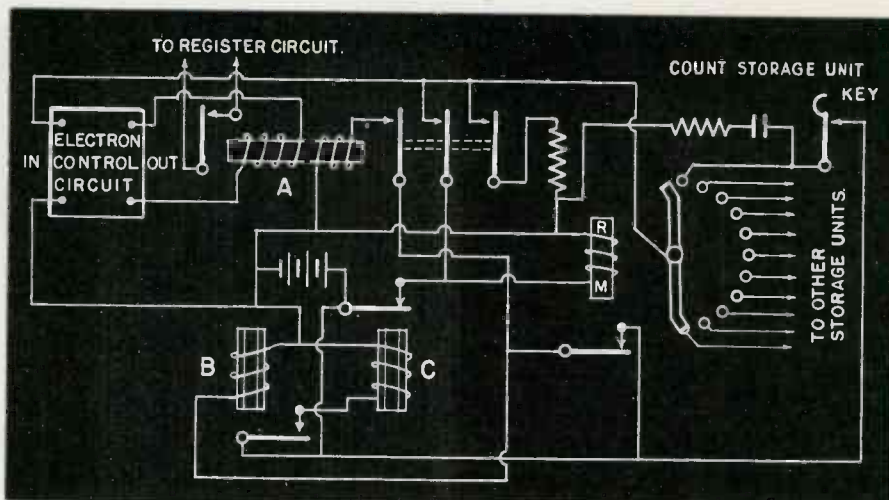
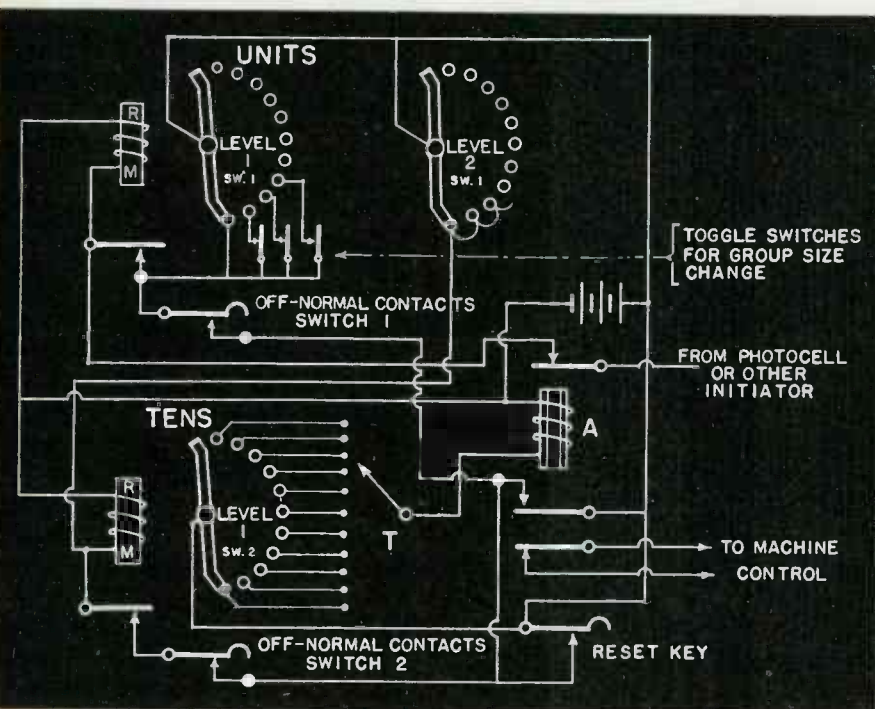

Fig. 6. Totalizing circuit with count storage

and it is here that the stepping switch is most useful. Combinations of stepping switches can be so wired as to count in almost any imaginable group size, as well as total count. A typical circuit is shown in Fig. 5.

It will be noted that when switch number 1 reaches the tenth contact, it automatically steps to the eleventh contact. At the same time switch No. 2 is advanced one step to register the tens group. It is obvious that several of the contacts on switch No. 1 could be connected to the self-stepping circuit through toggle switches to permit rapid change of the group size: i.e., the switch could count in groups of 9's, 8's, etc., stepping automatically

from the 9th, 8th or any desired contact to the 11th.

Level 1 of switch No. 2 is connected to relay A through a tap switch, T, and thus relay A can be connected to operate after any predetermined number of groups has been counted. Such operation restores both switches to normal. At the same time, it opens the machine control circuit as well as the initiating impulse circuit. Additional levels of the switches can be connected to pilot lamps, if desired, for remote indication of the count. The circuit to relay A could of course, be varied by the use of another tap switch and a level on switch 1 so that relay A would not be energized until the desired part of a given group had been counted.

A typical application of such a circuit is the folding machine used in many printing plants. With the conveyor operating at a continuous rate, folded pieces of literature drop on to the conveyor and are spaced equally. If, however, the folder is stopped momentarily at the end of every 25 operations, a longer space between pieces will result after each group of 25. It is then very simple for an operator to pick-up the bulletins in stacks of 25, with no chance for a human error. He is thus able to tend several folders.

Totalizing

Totalizing is a continuation or elaboration of counting. For example, it is often desirable to accumulate or totalize the count from several different machines on one master counter. Fig. 6 shows a totalizing counter employing an

electronic device for detection of the count.

Here machine operations are registered by closures of initiating contacts K and stored on individual condensers associated with each initiating switch. The stepping switch RM actually functions as a distribution, since it successively connects to the various condenser circuits under control of relays B and C, and by means of an electron tube circuit operates the A relay if a count has been stored on the condenser. The contacts on the A relay in turn operate the master register or counter, thus furnishing a total count.

The stepping switch must connect to each condenser sufficiently often to insure that two initiating contact operations have not occurred between connections, thus losing one. This is obtained by proper selection and adjustment of relays B & C to generate impulses at the required rate. The circuit from the contact of the C relay through the contacts of the A relay to the wiper destroy the stored closure as soon as it has been registered, as indicated by the operation of the A relay.

Fig. 7. The Strowger 2 motion stepping switch with control relays as used in automatic telephony

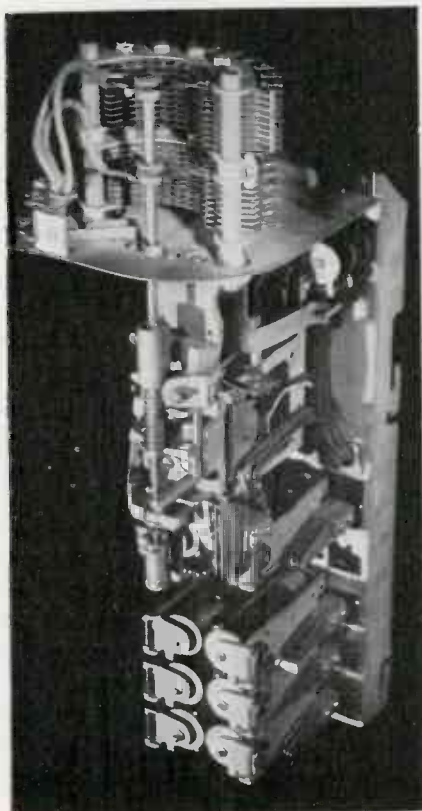

Characteristics	Strowger Two-Motion Switches Vert.	Rotary	11-Point Rotary Switch	25-Point Rotary Switch	Minor Switch
Maximum Theoretical Impulse Speed, Steps/Second	25.5	39	30.5	36.5	35.5
Min. Length Impulse at 10 p.p.s. in per cent make	25%	20%	23%	22%	16%
Max. Length Impulse at 10 p.p.s. in per cent make	87%	94%	94%	95%	90%
Ideal Impulse Ratio at 10 p.p.s. (make)	68%	76%	78%	80%	60%
Average Self-Interrupting Speed Steps/Second		43	52	50	
Release Magnet Operate Time, Seconds	.019				.0085
Total Rotary Release Time from 10th Contact, seconds	.042				.030
Total Release Time Including Shaft Bounce and Contact Chatter, seconds					.058
Vertical Dropping Time From 10th Level, seconds	.104				
Total Release Time From 10th Contact on 10th Level, seconds	.146				
Minimum Expected Life	1,500,000 cycles of five vertical and five rotary steps	5,000,000 half revolutions of wipers	5,000,000 half revolutions of wipers	3,500,000 ten step cycles	
48 Volt Operating Magnet Resistance	57 ohms total for rotary or vertical	100 ohms	100 ohms	155 ohms inductive winding	
Magnet Spark Protection	1MF-200 ohms	1MF-200 ohms	1MF-200 ohms	900 ohms non-inductive winding	

Figure 8. Performance Data for 48 Volt Switches

The interlock circuit from the stepping switch springs through the contacts and coil of the A relay hold the A relay operated until the stepping switch passes on to the next contact, thus insuring a long impulse for proper registration. Furthermore, if an initiator contact is closed when the stepping switch picks up that circuit, the magnet will be held operated until the initiating contact opens, thus insuring that one closure will not be registered twice. Negative potential or battery through the resistor and contacts of the relay A discharges the storage condenser, and thus destroys a stored count as soon as it has been registered.

Switch sizes

There are a variety of stepping switches available for use in selection, distribution, counting, and totalizing in electronic applications.

First it should be noted that stepping switches are available on the basis of what might be termed size: i.e., number of contacts per wiper, or the number of successive secondary circuits that can be handled.

There are switches with 10, 11, 25, 50 and 100 contact capacity. These are commonly spoken of in terms of points rather than contacts, thus, a 25-contact switch is called a 25-point switch.

Up through the 50-point switch, single motion of the wiper is used, and because the motion is rotary these switches are also known as rotary switches. The 100-point switch (Fig. 7), however, employs two-motion operation of the wipers. The first series of impulses received by the switch mechanism steps the wipers in a vertical direction to reach the desired tens group, while the second set of impulses rotates

(Continued on page 140)

NEW

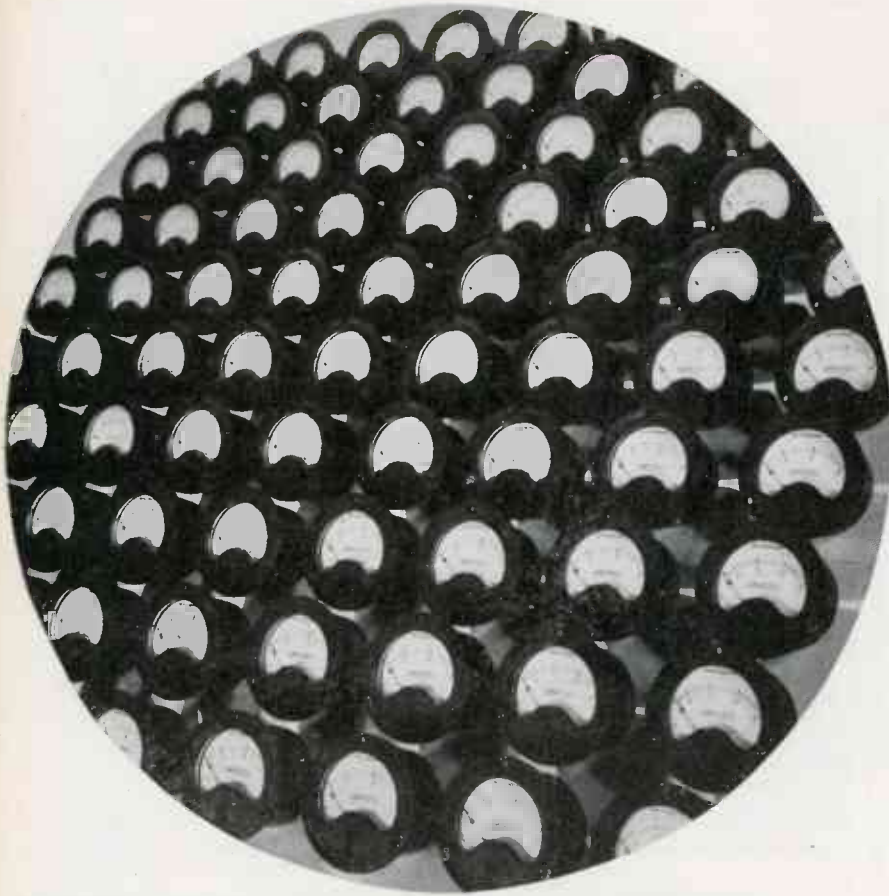

Round meters are now War Standard; rectangular cases are "out"

ments and the equipment using them and will avoid the necessity for unduly large stocks of spare instruments in repair depots of the Armed Forces spread over the face of the globe from Iceland to the jungles of the South Pacific.

No "square" meters

Conspicuous by their absence from the new standard are rectangular or "square" faced meters. Originally furnished by instrument manufacturers as a result of peacetime pressure from equipment designers seeking "streamlined eye-appeal," this style of instrument was unanimously discouraged for war-time use by both the Armed Forces and the instrument industry. Compared to round, flush-mounting, molded-case instruments which have been set up as standard for war-time usage, the rectangular instruments use more molding material, take longer to mold, use additional brass in mounting studs, necessitate extra drilling of equipment panels and are often cracked by unequal tension on the mounting studs.

Likewise omitted from the new standard as unnecessary under war-time conditions are both front-of-board mounting and clamp-mounting narrow-rim instruments, since equipment can usually with little trouble be designed to avoid their use.

Metal-cased instruments are not included in this standard since simple lightweight shields used with the standard molded-cased instruments can serve adequately in the few cases where shielding is necessary. The use of metal-cased instruments where no question of shielding was involved has wasted much brass and necessitated many additional replacement instruments since this type of case has a tendency to incur cover-glass cracks through adjuster openings.

With a tremendously increased demand for electrical indicating instruments far exceeding the pre-war capacity of the American instrument industry, manufacturers of electronic and communications equipment have found themselves handicapped in securing alternate sources of supply for meters because of lack of interchangeability of instruments made by different manufacturers. This problem has been most serious in the case of 2½- and 3½-inch panel-type instruments.

Upon occasion when attempts have been made to divert instrument production to urgently needed equipment from that having a lower priority, it has been found impossible to do so because of lack of instrument standardization. Instrument production has at the same time been handicapped by a multiplicity of orders for instruments basically the same but varying in the superficial details of external design which make for mechanical interchangeability.

As the situation grew more serious last summer, the War Production Board requested the War

Committee on Electrical Indicating Instruments of the American Standards Association to find a solution for the problem. This has now been done in a new American War Standard for Electrical Indicating Instrument (2½- and 3½-Inch Round, Flush-Mounting, Panel-Type) C39.2-1943, which has already been adopted by the Signal Corps Standards Agency to replace former Army specifications for procurement purposes. Likewise, the Bureau of Ships of the Navy Department has authorized the acceptance of panel-type instruments for naval use when made to the new American War Standard rather than to existing Navy specifications.

The new standard, written in Federal Specification form so that it may be used directly for procurement by all government agencies not only provides for interchangeable instruments, but also sets up a single performance specification for instrument manufacturers to comply with instead of the numerous specifications issued by prime contractors and government agencies in the past. Its use will facilitate production of both instru-

COMPACT 50-KW POWER AMPLIFIER



Steerable short-wave antenna directed at Rio de Janeiro or Buenos Aires

Radio-frequency amplifiers which must operate on high power and high frequencies are most stable and efficient when they have short direct rf connecting leads, construction is simple and certain circuit elements are lumped and com-

pact. This is particularly true of amplifiers which must operate on several widely different frequencies.

The problems requiring a satisfactory solution are conflicting. One is to build the circuit elements close to each other to minimize the

by **RAYMOND F. GUY**

Radio Facilities Engineer,
National Broadcasting Co.

Efficient short-wave unit of NBC's broadcasting stations WRCA and WNBI

length of the connections. Another is to provide adequate insulation and arc-over distances with a satisfactory safety factor. Another is to feed dc and cooling water in and take rf power out without complicating the design and adding parasitic reactance.

The design of the neutralizing capacitor is directly involved in this problem since it must normally be built to withstand the sum of the dc plate voltage and the rf voltage. Compressed-air neutralizing capacitors were used by NBC engineers to solve this problem in the WRCA and WNBI power amplifiers. These units, of which there are three, handle over 200 kw each on modulation peaks.

Single streamlined assembly

The approach to the problem was direct. Engineer Carl Dietsch, who developed and built the equipment, combined the anode circuits, the neutralizing capacitors and the tuning capacitor into one streamlined assembly and combined dc, tank current and cooling water in one metallic connecting circuit.

The tank circuit inductance consists of dual one-inch-square bronze pipes which also carry distilled water to and from the tube



At left—Main transmitter room, with power-amplifier panel in background. Below—Horizontal section through amplifier shows electrical & water circuits

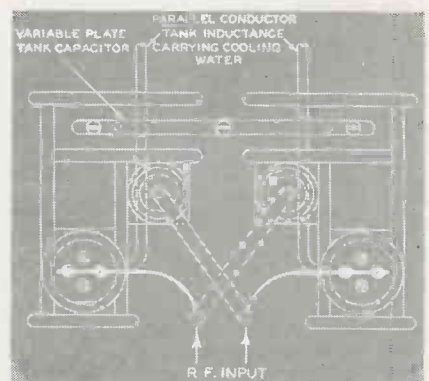



The 50-kw power amplifier unit as installed in panel in main transmitter room. Close-up at right shows unit before installation

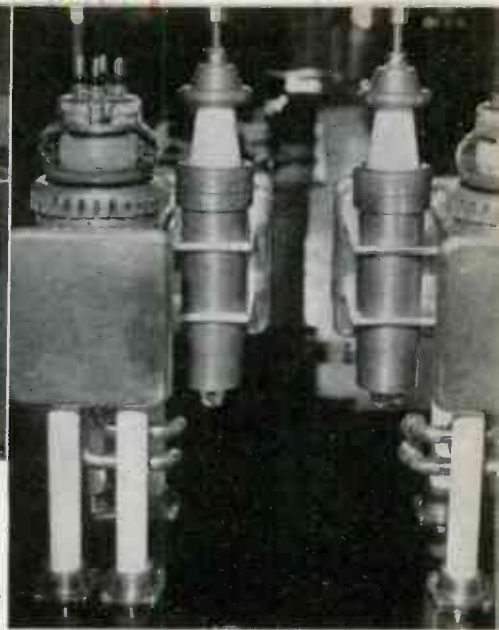

anodes, for cooling them, and modulated dc for the plate circuits.

The illustrations show the interesting amplifier circuit assembly used in the NBC stations. The amplifiers are push-pull units utilizing two RCA type 880 tubes of the "folded-back" high-frequency design. The essential parts of the tank circuit assembly are shown in the photographs and diagram. Duraluminum plates of one inch thickness are used and all corners and edges are carefully rounded and polished. The variable tank tuning capacitors consist of a single movable plate sliding vertically in the U shaped chambers on each side of the assembly as shown in the drawing. This plate may be grounded.

By this arrangement the reactances of all circuit elements to ground are perfectly balanced and stray capacitance is reduced to a low value. A wide range of tuning is accomplished by sliding the movable plate vertically by means of a counter-weighted mechanism controlled from the front of the amplifier.

Compressed-air capacitors

The compressed air neutralizing capacitors are kept at an air pressure of 150 lbs. per square inch but could be operated on a pressure as low as 60 lbs. per square inch. Their capacitance is variable and may be adjusted with the use of a socket wrench with a long insulated handle wrench to turn the threaded end rod which varies the length of a bellows in the pressure chamber. This type of compressed air capacitor was developed by RCA Communications, Inc. and adapted for broadcast use by NBC.

The tank circuit was designed for operation at full power up to 21 megacycles. It is very stable in operation and does not require neutralizing adjustments of any kind when frequencies are changed several times daily because of varying path conditions or because the stations shift beams to different parts of the world. It was not necessary in this design to resort to complex neutralizing bridge cir-

cuits to neutralize parasitic reactance in the circuit elements as it is sometimes necessary to do in high powered, high frequency transmitters.

Two of these transmitters have been operated for long periods synchronized to operate on the same frequency, thus producing a carrier power of 100 kw.

Array of short-wave antenna structures for international station WRCA

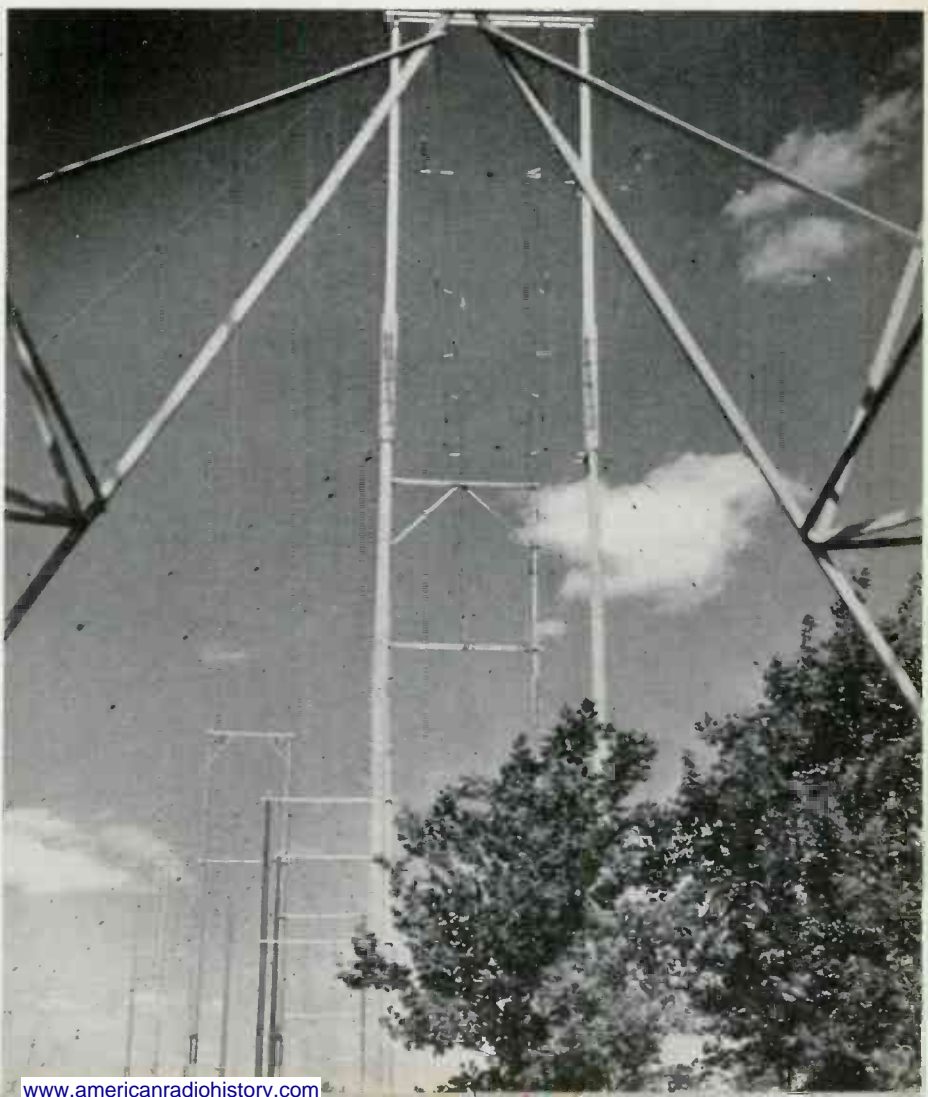

DECOUPLING FILTER

by H. JACOBOWITZ

Design factors for isolating R-C coupled amplifier stages

It is a well-known fact that in the design of high-gain amplifiers of more than two stages difficulties arise due to regeneration and degeneration. Regeneration or positive feedback occurs between an odd number of stages, since every other stage will have its plate currents flowing in phase through the common power supply impedance. The plate currents will be out of phase for an even number of stages resulting in negative feedback or degeneration. Regeneration leads to instability and may give rise to low frequency oscillations—"motor-boating"—due to the fact that at low frequencies the power supply impedance (largely capacitive) and therefore the feedback voltage, increases and may reach the critical value which satisfies the condition of oscillation. Degeneration results in loss of gain, which, however, is far less serious than the instability produced by regeneration.

"Brute-force" filter

While recently a new method of decoupling stages and preventing regeneration has been pointed out by Wen-Yuan Pan,¹ simple resistance-capacity combinations are still widely used as decoupling filters, since in most cases they are adequate for the job. The easiest way of designing a filter of this type is by use of an isolation resistor, the value of which may be as high as one is willing to sacrifice voltage developed across it, and a by-pass con-

denser the value of which in the upward direction is only limited by physical size. However, "brute-force" methods are not very popular at this time; large capacities mean large amounts of metal and other critical materials. The smallest value of capacity which does the job is the best.

Condition for stability

One may be reasonably sure that any high gain amplifier with more than two stages will require a decoupling filter. It is easy enough, however, to check up on this point by investigating, how well the amplifier in question will fulfill the following condition for stability, which holds for regeneration in a three-stage amplifier²:

$$A_{2n} \mu_n Z_{pp} \div \left[R_{L1} (R_{p1} + Z_{L1} + Z_{pp}) \left\{ \left(\frac{1}{R_{L1}} + \frac{1}{R_g} + \frac{1}{R_{p1}} \right)^2 + \left(\frac{1}{R_{L1}} + \frac{1}{R_{p1}} \right)^2 \div (R_g \omega C_c)^2 \right\}^{1/2} \right] \leq 1 \quad (1)$$

where;

$\omega = 2\pi f$; f = lowest frequency to which amplifier responds.

A_{2n} = gain from grid of 2nd tube to grid of last (third) tube.

Z_{pp} = magnitude of equivalent series impedance of the power supply (see Fig. 3).

μ_n = amplification factor of last (third) tube.

R_{p1} and R_{pn} = plate resistance of first and last tube respectively.

For the remaining symbols see Fig. 1.

This expression should be much less than "1" for high stability. In most cases it will probably be found that the expression is too close to or larger than "1" and decoupling becomes therefore necessary.

Time constant of filter

Fig. 2 shows the equivalent circuit of the amplifier of Fig. 1 with the decoupling filter R_f and C_f and the equivalent series impedance of the power supply Z_{pp} referred to the last stage under consideration. Coupling effects of intermediate stages are neglected in the following analysis, since they are small due to the low gain and tend to work in the opposite direction.

The impedance of the decoupling filter (R_f , C_f) is very high compared to the equivalent series impedance of the power supply Z_{pp} at the lowest frequency to which the amplifier responds and may therefore be assumed to have a negligible shunting effect on Z_{pp} .

$j \omega C_f + R_f \gg Z_{pp}$ and hence, $Z_f \approx Z_{pp}$.

let T = Time constant of decoupling filter = $C_f R_f$.

We can now derive the time constant "T" of the decoupling filter in terms of the maximum allowable rise in gain due to regeneration between alternate stages or the maximum allowable loss in gain due to degeneration between adjacent stages, and of the circuit components and tube characteristics.

The ratio of the voltage developed across the common supply impedance Z_{pp} , to the output voltage is equal to,

$$\frac{e_f^1}{e_o} = \frac{I_o Z_{pp}}{I_c Z_{L1}} = \frac{Z_{pp}}{Z_{L1}}$$

The voltage e_f developed across the filter condenser C_f is fed back to the plate of the first stage and equals,

$$e_f = \frac{e_f^1 j \frac{1}{\omega C_f}}{R_f + j \frac{1}{\omega C_f}} = e_f^1 \frac{1}{1 + j \omega T} \quad (2)$$

The feedback factor F ,

$$F = \frac{e_f}{e_o} = \frac{e_f^1}{e_o} \times \frac{1}{(1 + j \omega T)}$$

$$F = \frac{Z_{pp}}{Z_{L1}} \times \frac{1}{1 + j \omega T} \quad (3)$$

Fig. 1. Circuit of a multi-stage amplifier, in which the first and the last stage are to be decoupled by means of plate isolation filter R_f and C_f

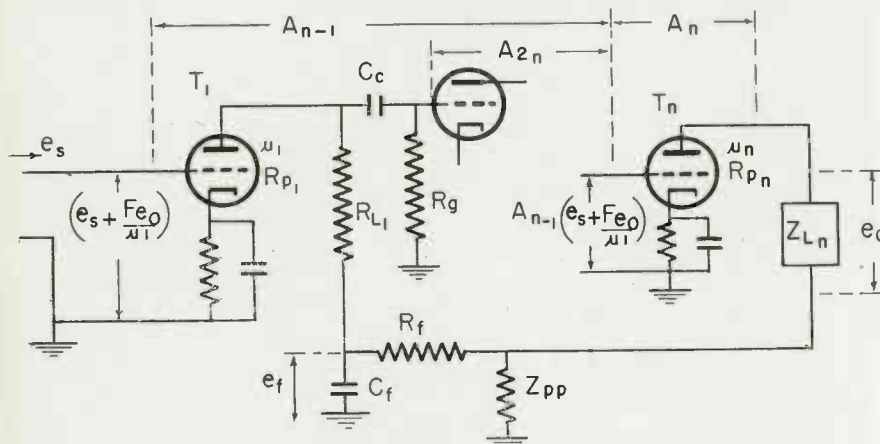

for PLATE ISOLATION

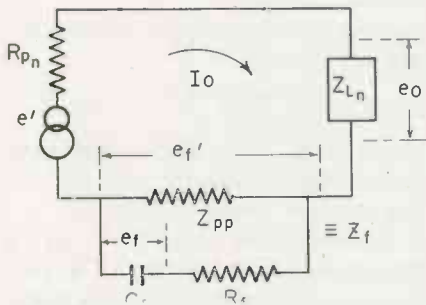

Fig. 2. Equivalent circuit of multi-stage amplifier, neglecting coupling effects except between first and last stage

(F is positive for regeneration and negative for degeneration.)

The voltage appearing in the plate circuit of the last stage (Fig. 2)

$$e^1 = \left[A_{n-1} \left(e_s + \frac{F e_o}{\mu_1} \right) \right] \mu_n \quad (4)$$

where: A_{n-1} is the gain from the grid of the first stage to the grid of the last stage. And $F e_o / \mu_1$ is the equivalent feedback voltage acting in grid circuit of tube 1. The output voltage,

$$e_o = \frac{e^1 Z_{Ln}}{R_{pn} + Z_{Ln} + Z_{pp}} \quad (5)$$

substituting (4) and rearranging

$$e_o = A_n A_{n-1} e_s + \frac{A_n A_{n-1} F e_o}{\mu_1} \quad (6)$$

where,

$$A_n = \frac{\mu_n Z_{Ln}}{R_{pn} + Z_{Ln} + Z_{pp}}$$

A_n is the gain of the last stage including Z_{pp} and (6) may be written,

$$e_o = A e_s + \frac{A F e_o}{\mu_1} \quad (7)$$

where $A = A_n \times A_{n-1}$ = the overall forward gain of the amplifier not considering the feedback through the filter R_f, C_f .

The gain taking into account feedback is

$$G_f = \frac{e_o}{e_s} = \frac{\mu_1 A}{\mu_1 - A F} = \frac{A}{1 - \frac{A F}{\mu_1}} \quad (8)$$

Let the ratio of the gain without feedback to the gain with feedback equal

$$N = \left| \frac{A}{G_f} \right| = \left| 1 - \frac{A F}{\mu_1} \right| = |M| \quad (9)$$

where,

$$M = \frac{A F}{\mu_1}$$

and $N = 1 / \text{Antilog} \left(\frac{\text{db gain}}{20} \right)$, in the case of

regeneration and is less than "1". The "db gain" is the maximum allowable rise in gain expressed in decibels due to regeneration.

$N = \text{Antilog} \left(\frac{\text{db loss}}{20} \right)$ in the case of degeneration, and is larger than "1". The "db loss" is the maximum allowable drop in gain due to degeneration.

The vector M may be written in trigonometric form:

$$M = |M| \cos \Theta_m + j |M| \sin \Theta_m \quad (10)$$

$$N = 1 - M = 1 - |M| \cos \Theta_m - j |M| \sin \Theta_m$$

$$|N| = \sqrt{(1 - |M| \cos \Theta_m)^2 + |M|^2 \sin^2 \Theta_m}$$

$$|N^2 - 1| = -2|M| \cos \Theta_m + |M|^2 \quad (11)$$

$$M = \frac{A F}{\mu_1} = \frac{A Z_{pp}}{\mu_1 Z_{Ln} (1 + j \omega T)}$$

A, Z_{pp} , Z_{Ln} , are vector quantities having a magnitude and a phase angle. Therefore

$$M = \frac{|A| / \Theta_A \times |Z_{pp}| / \Theta_{Z_{pp}}}{\mu_1 |Z_{Ln}| / \Theta_{Z_{Ln}} \times \sqrt{1 + \omega^2 T^2} / \Theta_T} \quad (12)$$

where: Θ_A , $\Theta_{Z_{pp}}$ and $\Theta_{Z_{Ln}}$ are the phase angles of A, Z_{pp} and Z_{Ln} and $\Theta_T = \arctan \omega T$.

Equation (12) may be rewritten

$$M = \left| \frac{A \times Z_{pp}}{\mu_1 \times Z_{Ln} \times \sqrt{1 + \omega^2 T^2}} \right| / \Theta_K - \Theta_T \quad (12a)$$

where: $\Theta_K = \Theta_A + \Theta_{Z_{pp}} - \Theta_{Z_{Ln}}$ and $\Theta_K - \Theta_T = \Theta_m$.

From equation 11,

$$N^2 - 1 = -2|M| \cos (\Theta_K - \Theta_T) + |M|^2 \quad (13)$$

Since,

$$\cos \Theta_T = \frac{1}{\sqrt{1 + \omega^2 T^2}}$$

and

$$\sin \Theta_T = \frac{\omega T}{\sqrt{1 + \omega^2 T^2}}$$

Let

$$M = \frac{H}{\sqrt{1 + \omega^2 T^2}}$$

where

$$H = \left| \frac{A Z_{pp}}{\mu_1 Z_{Ln}} \right| \quad (\text{see } 12a)$$

Then (13) may be written,

$$N^2 - 1 = \frac{-2H \cos \Theta_K}{(1 + \omega^2 T^2)} - \frac{2H \sin \Theta_K \omega T}{(1 + \omega^2 T^2)} + \frac{H^2}{(1 + \omega^2 T^2)} \quad (14)$$

or,

$$T^2 \left[\omega^2 (N^2 - 1) \right] + T(2 \omega H \sin \Theta_K) + \left[(N^2 - 1) + 2H \cos \Theta_K - H^2 \right] = 0 \quad (15)$$

solving (15) for "T", we derive

$$T = \frac{\left[(H \sin \Theta_K)^2 - (N^2 - 1)(N^2 - 1 + 2H \cos \Theta_K - H^2) \right]^{1/2} - H \sin \Theta_K}{\omega (N^2 - 1)} \quad (16)$$

(it may be shown that only a positive sign preceding the square root will give the correct solution).

where: $\Theta_K = (\Theta_A + \Theta_{Z_{pp}} - \Theta_{Z_{Ln}})$

and Θ_A = overall phase shift of the amplifier at "ω"

$$H = \pm \left| \frac{A Z_{pp}}{\mu_1 Z_{Ln}} \right|$$

H is + for regeneration, first and last stage separated by an odd number of stages: 1, 3, 5, n,

- for degeneration, first and last stage separated by an even number of stages: 0, 2, 4, n-1, n+1.

$$|Z_{pp}| = (R_{pp}^2 + X_{pp}^2)^{1/2}$$

where R_{pp} and X_{pp} are the equivalent series resistance and series reactance of the power pack (see Fig. 3).

$\omega = 2\pi \times$ lowest frequency to which amplifier responds.

(Continued on page 150)

Fig. 3. Equivalent series impedance of power supply

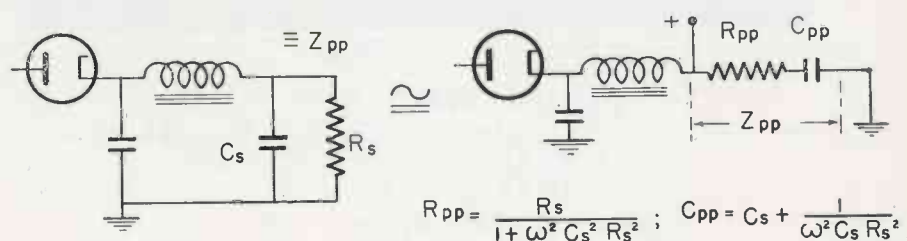

FUSE PROTECTION of

A transformer may be protected from overload damage by installing some device in the primary circuit to disconnect it whenever the current exceeds a predetermined safe value. Fuses are often used for this purpose due to their simplicity and ability to give protection when they have been properly selected. The fuse may also serve to prevent damage to a load drawing abnormally high current, and to prevent overheating the primary supply line in case of complete failure of the transformer.

Satisfactory operation of the equipment demands that the fuse shall continuously carry the normal primary load current; that it shall

blow only when the transformer is actually in danger; and that the initial current inrush when the transformer is first energized shall not blow the fuse.

Normal load

The normal primary load current of a transformer is dependent upon the connected load, the efficiency of the transformer, and the primary voltage. A reactive load will require consideration of power factor. The usual transformer efficiencies will vary from about 80 per cent for 20 VA units to about 97-98 per cent for 5 KVA dry-type units. The approximate primary current of the loaded transformer

may be calculated from the following expression:

$$I_p = \frac{(\text{Secondary}) EI}{k E_p \cos \theta} \text{ amperes.}$$

where k is a constant expressing transformer efficiency, and $\cos \theta$ is the primary power factor.

Shorting the secondary of a transformer can result in a primary current of from 5 to 50 times normal load current, depending upon the internal impedance of the transformer windings. This impedance varies from 20 per cent for very small units of 10-20 VA to about 2 per cent for air-cooled dry type units of 5-7 KVA, and depends upon the design of the transformer. This variation of impedance exists because the losses per unit volume must be decreased as the transformer becomes larger.

The radiation of heat depends upon the surface area, and the ratio of area to volume decreases as the dimensions of the unit are increased. A reduction in losses per unit volume requires the use of larger wire, and consequently the current density in amperes per square inch of conductor is reduced. The larger wire will result in decreased winding resistance and so the primary current can reach higher values when the secondary is short circuited. It also follows that a small transformer designed to have either very good regulation or very low temperature rise will be expected to have a high ratio of primary short circuit to load current.

Current density

The current density in the windings is usually kept between the limits of 700 to 2700 amperes per square inch in commercial design practice. An approximate estimation of the usual corresponding relation between current density and VA rating has been noted along the abscissa of the chart, Fig. 1. This, of course, is only approximate, and subject to many design variations.

The family of curves given in Fig. 1 is derived from Equation (6)

Fig. 1. Temperature rise vs. overload factors

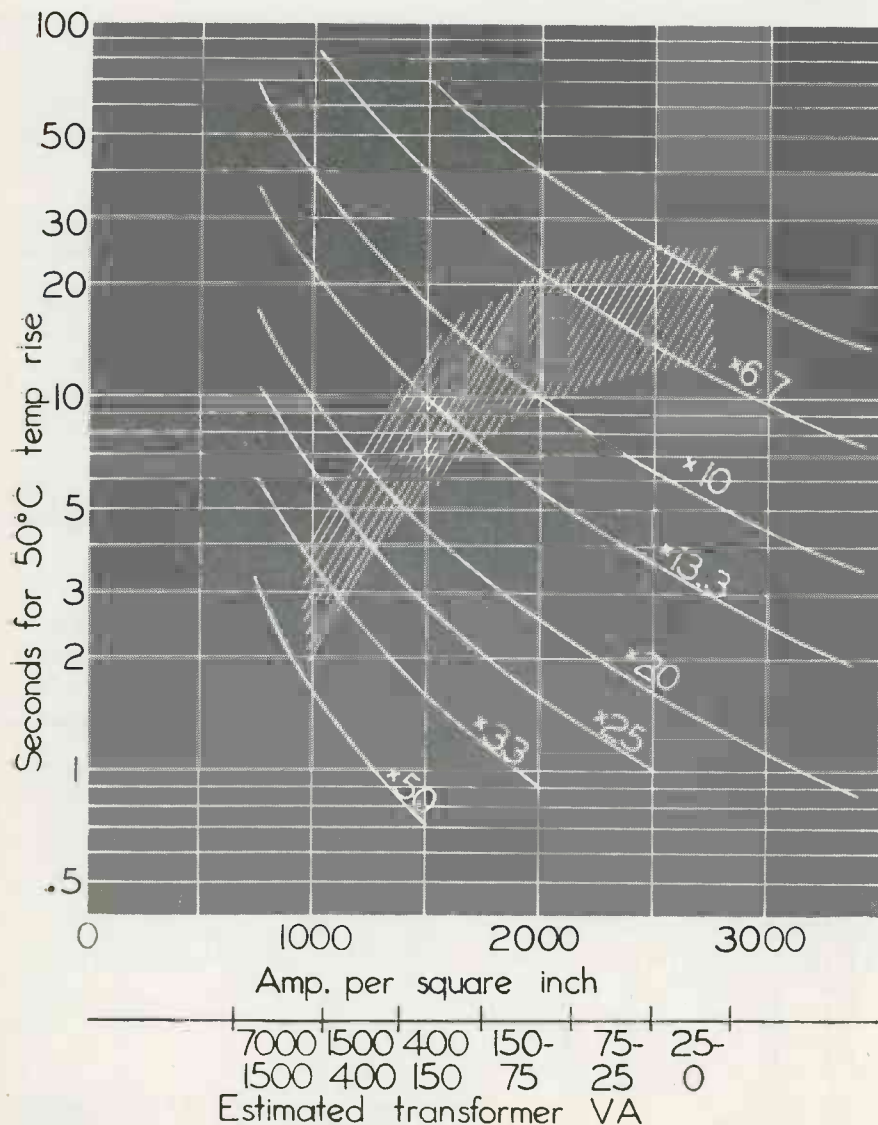



23 MUSICAL TONE PICTURE. STUDY OF MUSIC AND SOUND CHARACTERISTICS AND PITCH.



24 FIRING STRESSES IN GUN BARRELS CAN BE DELINEATED USING STRAIN-GAGES.



25 CYLINDER PRESSURE DIAGRAM IN DIESEL, BASE LINE REPRESENTS 120° SHAFT ROTATION. GAS-ENGINE INDICATOR DIAGRAM SHOWS RATE-OF-CHANGE IN CYLINDER PRESSURE.

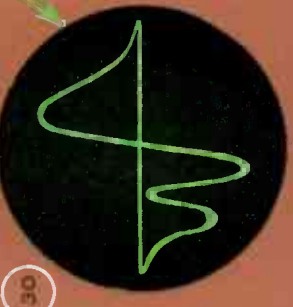

26 SQUARE WAVE CHECKED WITH INTERRUPTED TRACE, TIMED BY "Z" AXIS CONTROL.



MICROPHONE



FILTER



PRESSURE PICK-UPS



27 5000-CYCLE SQUARE-WAVE MEASUREMENTS ON AN AMPLIFIER, LIGHTLY LOADED.



28 SAME TESTS AS NO. 27. SHOWS SPURIOUS RESONANCE WITH OUTPUT UNLOADED.



29 SQUARE WAVE CHECKED WITH INTERRUPTED TRACE, TIMED BY "Z" AXIS CONTROL.



30 SURGE VOLTAGES, TRANSIENTS APPEARING ON HIGH VOLTAGE TRANSMISSION LINE.

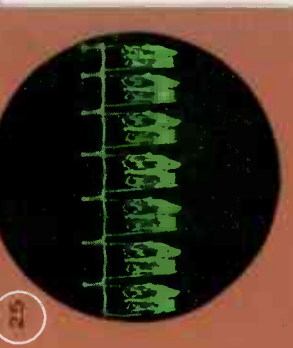

31 SEVEN LINES OF TELEVISION PICTURE SHOWING HORIZONTAL SYNCHRONIZING PULSES.



POWER UNIT and BEAM CONTROLS



INTENSITY MODULATION AMPLIFIER

IMPEDANCE TRANSFORMER

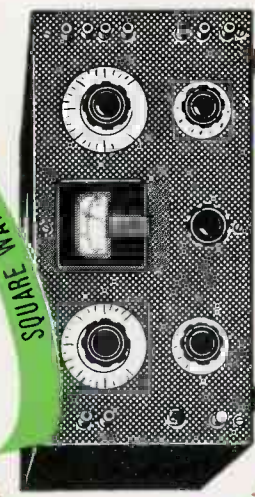

SQUARE WAVE OSCILLATOR

VERTICAL DEFLECTION AMPLIFIER



THE CATHODE

in the physical sciences, education in center, with some accessories, has become the ever de

COMPILED BY R. R. BATCHER OF "ELECTRONIC INDUST



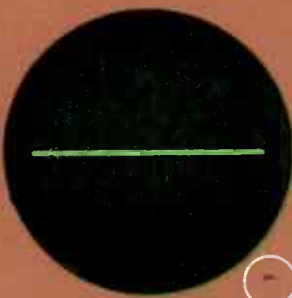

1 USED AS VACUUM-TUBE VOLTMETER, READS PEAK VOLTS AT ANY FREQUENCY.



2 DOUBLE TRACE USING ELECTRONIC SWITCH, SINE-WAVE FREQUENCY COMPARISONS.



3 DOUBLE TRACE USING ELECTRONIC SWITCH, SINE & SAWTOOTH WAVES COMPARED.

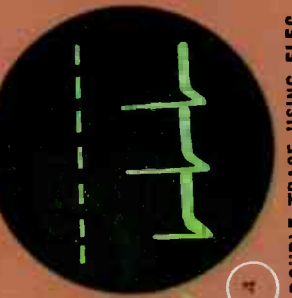

4 DOUBLE TRACE USING ELECTRONIC SWITCH, PULSE FROM NERVE STIMULATOR.



5 WAVE STUDIES WITH TEST WAVE APPLIED TO AN ELLIPTICAL TIME BASE.

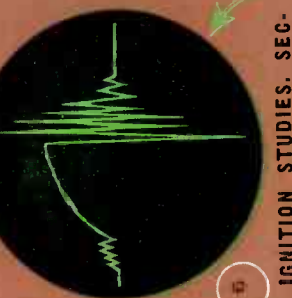

6 IGNITION STUDIES, SECONDARY POTENTIAL WAVE ACROSS SPARK PLUG.

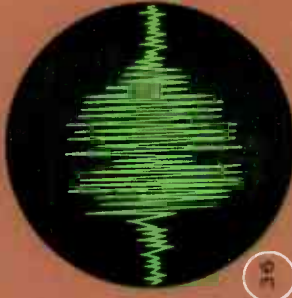

36 VIBRATION STUDY IN MACHINERY, PRELIMINARY TO DYNAMIC BALANCING.



35 MUSICAL TONE, WITH VIBRATION PICK-UP APPLIED TO MUSICAL INSTRUMENT.



34 GEOPHYSICAL EXPLORATION.



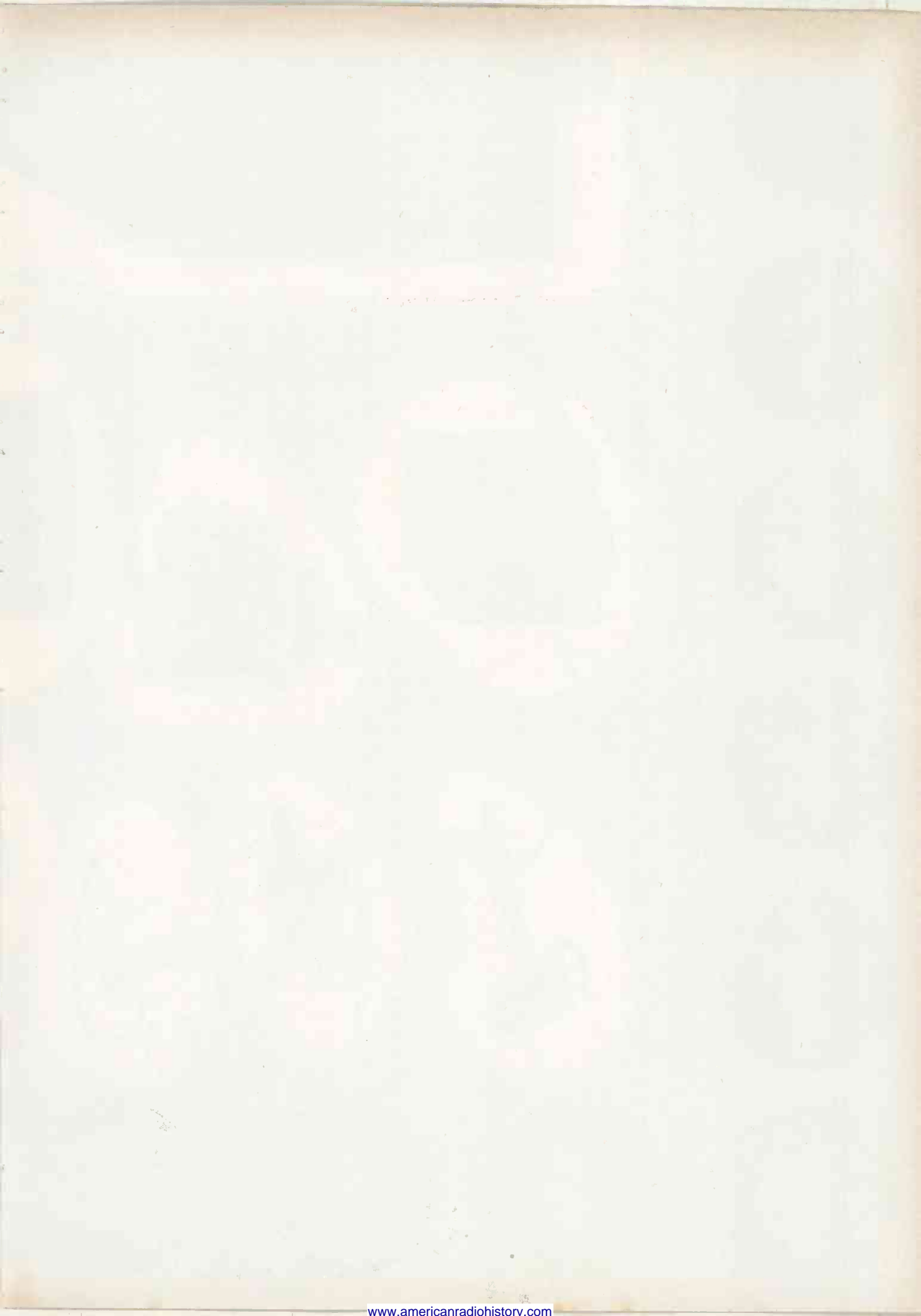

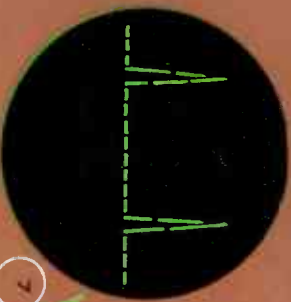

7 BALLISTIC STUDIES. BEAM MODULATION OR "Z" AXIS GIVES TIME DOTS ON LINES.



8 RADIOPHONE TESTS SHOWING R. F. LEAKAGE INTO AUDIO AMPLIFIER SYSTEM.



9 MODULATED R.F. SIGNAL, USING LINEAR TIME BASE IN THE OSCILLOGRAPH.



10 MODULATED R.F. SIGNAL, USING AUDIO MODULATING TONE AS THE TIME BASE.



11 SIMILAR TO 10 (at left) BUT WITH A PHASE SHIFT SHOWING IN AUDIO SYSTEM.



12 LISSAJOU FIGURE, TWO SINE WAVES APPLIED TO DEFLECTION PLATES WITH 5:1 RATIO.



13 AN AUDIO-FREQUENCY TONE WITH STRONG 15th HARMONIC OR OVERTONE SUPERPOSED.



14 OUTPUT FROM CLIPPER AMPLIFIER IN A TYPE OF WAVE SHAPING CIRCUIT.



15 CIRCULAR OSCILLOGRAM, APPLIED VOLTAGE MOVES RADII.



SPECIAL SWEEP



PRECISION FORK



AUDIO OSCILLATOR



ANGULAR SWEEP



PHOTO CELLS



HORIZONTAL DEFLECTION AMPLIFIER

TIME BASE GENERATOR

FREQUENCY-MODULATED OSCILLATOR

MAGNETIC SEARCH COILS

TO VERTICAL AMPLIFIER

MAGNETIC COMPARATOR

RECORDING CAMERA & TIME BASE

RAY OSCILLOGRAPH

tion and industry. The oscillograph, frequently associated apparatus and most versatile measuring instrument used by science.

"S" IN COOPERATION WITH ALLEN B. DUMONT LABORATORIES, INC.

TELEVISION SYNCHRONIZATION SIGNAL FOR HORIZONTAL SCANNING CONTROL.

A TELEVISION SIGNAL DE-LINEATED, DUMONT SYSTEM SYNCHRONIZING SIGNAL.

IONOSPHERE ECHO, TIMING OF REFLECTED RADIO SIGNAL USING CIRCULAR TIME BASE.

ELECTROCARDIOGRAM, DE-LINEATES ELECTRICAL SURGE GENERATED BY HEART BEAT.

MAGNETIC COMPARISON, IDENTICAL CHARACTERISTICS GIVES STRAIGHT HORIZONTAL LINE.

ADJUSTING I-F TRANSFORMERS, BETTER, BUT RESONANCE CURVE UN-SYMMETRICAL. MAGNETIC HYSTERESIS OR B-H CURVES OF A TRANSFORMER LAMINATION SAMPLE.

OSCILLOGRAM OF THE STRAY MAGNETIC FIELD RADIATED FROM AN ALTERNATOR.

ADJUSTING I-F TRANSFORMERS, SHOWS MISALIGNMENT AS TO FREQUENCY SETTING.

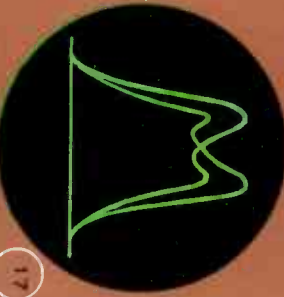

Small Power Transformers

by ROBERT M. HANSON*

Factors controlling type and rating of primary fuses for transformers of single and multiple secondaries

(given later in this discussion), and gives the time after the secondary is shorted for the winding to attain a temperature rise of 50 deg. C. Normal operating current densities are plotted as the abscissa, and curves are given for various short circuit currents of from 5 to 50 times normal load current. The value of 50 deg. C. temperature rise was selected as a permissible short time increase of winding temperature that would not unduly reduce the life of the equipment. The life of the types of insulation generally used in small transformer construction is a function of temperature. A reasonable increase in temperature for a short period will cause only a very small decrease in life providing this temperature does not cause charring or other physical deformation.

Limits of operation

The shaded area of the chart, Fig. 1, represents an estimate of the usual limits of operation resulting from normal design practice. The chart is useful in selecting the proper fuse because it gives the permissible duration of the short circuit current (before attaining 50 deg. C winding temperature rise), and also indicates the probable magnitude of this current. If data regarding the operating current density and the ratio of short circuit to primary load current are known, the chart may be used as a reasonably close figure of the time for the winding rise to approach 50 deg. C. If these data are not available, the approximate VA distribution abscissa may be used as a rough guide for the current density and the shaded area as a guide to the probable short circuit current ratio.

For example, a 125 VA transformer (see picture) will probably have a current density around 1800 amperes per square inch, and the short circuit current may be about 8 to 13 times normal load current.

If the ratio is 8 the circuit must be opened in 20 seconds, or if the factor is 13, the circuit must be opened in 8 seconds. This information is very useful in the selection of fuses having a time lag.

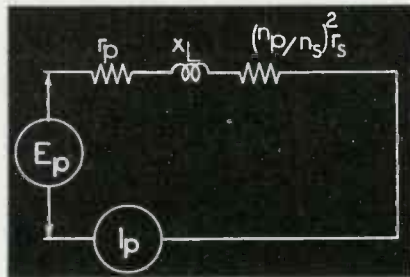

Fig. 2. Equivalent primary for shorted secondary

The short circuit current of a single secondary transformer is determined by the equivalent circuit shown in Fig. 2. The exciting current should be negligible and will not be considered.

- r_p —resistance of primary wire
- r_s —resistance of secondary wire
- N_p/N_s —turn ratio primary to secondary
- X_L —leakage reactance referred to primary
- E_p —primary line voltage
- I_p —primary current

If the leakage reactance (usually very small) is neglected the short circuit current will be expressed as follows:

$$I_p = \frac{E_p}{r_p + (N_p/N_s)^2 r_s} \text{ amperes. (1)}$$

In most transformer designs the primary resistance r_p will be approximately equal to the equivalent secondary resistance $(N_p/N_s)^2 r_s$.

Fig. 3. Equivalent primary for loaded secondary

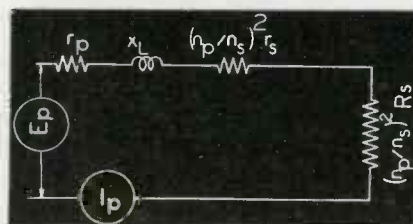

A similar equivalent circuit Fig. 3, may be used to determine the normal load current. R_L is the load resistance in ohms.

$$I_p = \frac{E_p}{r_p + (N_p/N_s)^2 (r_s R_L)} \text{ amperes. (2)}$$

The ratio of short circuit primary current to normal primary load current may be found by dividing equation (1) by equation (2). Dividing and simplifying we have:

$$\frac{I_p \text{ (short circuit)}}{I_p \text{ (normal load)}} = 1 + \frac{(N_p/N_s)^2 R_L}{r_p + (N_p/N_s)^2 r_s} \text{ (3)}$$

The total equivalent winding resistance of the transformer as represented by the denominator of Equation (3) will vary from 2 per cent to 25 per cent of the equivalent load resistance given in the numerator. This establishes the limits for the ratio of short circuit current to normal load current as being between 5 and 51.

Temperature rise

The temperature rise caused by short circuit of a transformer secondary winding may be calculated with reasonable accuracy after assuming that all heat will be stored in the copper and then none will be radiated. This assumption is reasonable because the short time of permissible operation on short circuit does not permit conduction of appreciable amount of heat from the winding. The final temperature of the copper will be determined by the amount of heat energy delivered to it, and in watt seconds this will be equal to $I^2 R T$.

A relationship may be expressed between the temperature rise, winding current density in amperes per square inch, and the time in

*Robert M. Hanson was born at Plains, Montana, in 1914. Graduated from Montana State College in 1936 with degree of B.Sc. in Electrical Engineering. Studied radio engineering at RCA Institute, Chicago, and obtained radio telephone first-class license. Joined engineering department of Thordarson Electric Mfg. Co. in 1936 and specialized in broadcast equipment development and high-power audio transformers. Now serving Thordarson as research and design engineer. Has been regular member of Ohio State University Broadcast Engineering Conference.

seconds. The development of this expression is as follows:

Temperature rise after short circuit of windings, assuming all heat to be stored in windings, and neglecting the increase of resistance due to the temperature coefficient of resistance.

$$\text{Energy} = k_1 m (t_2 - t_1)$$

$$i^2 R T = k_1 m (t_2 - t_1)$$

and:

- k_1 = Specific heat
- A = Area of conductor
- L = Length of conductor
- $m = k_2 A L$ or mass of copper
- $R = \frac{k_3 L}{A}$ or resistance of copper.

substituting:

$$\frac{i^2 k_3 L T}{A} = k_1 k_2 A L (t_2 - t_1)$$

or:

$$(i/A)^2 T = k (t_2 - t_1)$$

Evaluation of constants:

- i amperes
- A conductor area in sq. in.
- t_2 final temp. in degrees Cent.
- t_1 start temp. in degrees Cent.
- T time in seconds

$$(i/A)^2 T = 0.813 \times 10^8 (t_2 - t_1)$$

$$T = \frac{0.813 \times 10^8 (t_2 - t_1)}{(i/A)^2} \text{ seconds} \quad (4)$$

$$i/A = 0.9 \times 10^4 \sqrt{\frac{(t_2 - t_1)}{T}} \text{ Amperes per sq.} \quad (5)$$

$$(t_2 - t_1) = 1.23 \times 10^{-8} T (i/A)^2 \quad (6)$$

An inrush of current approaching the short circuit current in magnitude may sometimes occur when the primary circuit of a transformer is closed. The presence of this surge depends upon the magnetic state in which the transformer core material was left when the unit was previously turned off, and upon the part of the voltage cycle applied when the circuit is again closed. The dura-

tion of this transient surge is usually only a few cycles, and it is not expected to occur every time the power is turned on. This condition makes it difficult to use ordinary fuses of a current capacity that will give overload protection, and still not blow occasionally when the primary switch is closed. There are several types of thermal cutout devices available having a long time lag for large transient currents, and still retaining the ability to blow before a small steady overload can damage the equipment. As an example, one such type of commercially available fuse is rated to open in approximately 10 seconds on 5 times rated current and to open in 1 hour with 130 per cent rated load.

Slow-action fuses

Fig. 4 gives the overload-time characteristics of one type of slow action fuse. Such fuses might be selected for use with the 125 VA transformer previously mentioned. Assume a 125 volt line.

Fig. 4. Fuse action time vs. overload factor

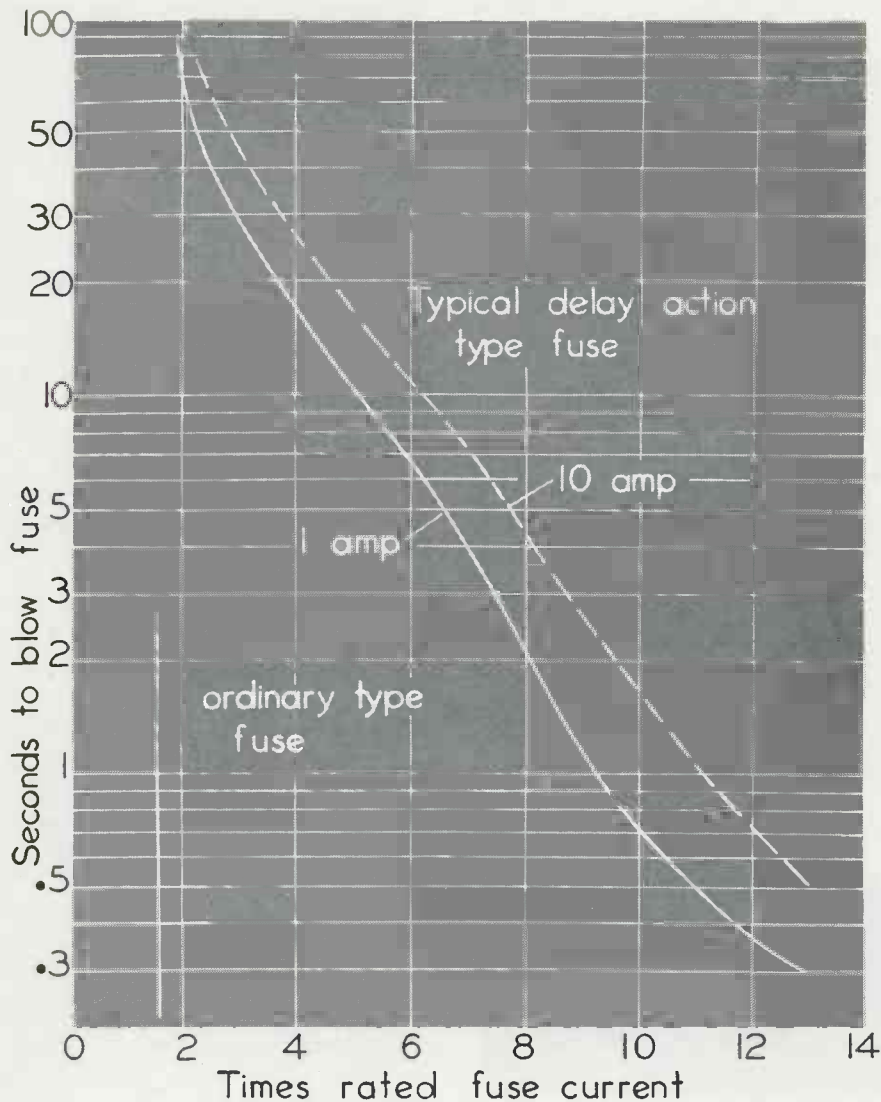

Pri Amps Normal	Shorted	Seconds Limit	Fuse Rating	Fuse Opening Time-seconds*
1.0	8	20	1.0	2.0
1.0	8	20	1.6	20.0
1.0	13	8	1.0	0.4
1.0	13	8	1.4	0.8

*Data taken from fuse manufacturers published data.

It is apparent that the time-temperature characteristics of this type of delayed action fuse is quite similar to that of the transformer, and that the wide variations in short circuit current of 8 to 13 would make only a slight difference in the fuse to be selected. The first commercial size of this type of fuse, larger than the primary current, would be the proper one to use. The time delay will be adequate to prevent opening from the initial current surge, and the opening time will also be well within the permissible time limit to prevent overheating and damage to the transformer.

Fuses of this type depend upon I^2R losses heating the element for their operation. Consequently they may be expected to introduce resistance into the primary circuit and lower the supply voltage available at the primary. This voltage drop may be as high as 10-20 volts

for the very small fuse ratings, and would require suitable primary winding taps if the transformer is to deliver the proper secondary load voltage.

Multiple windings

Small power transformers are often constructed with several secondary windings. A very frequent combination is three windings, one to supply high voltage to the rectifier plates, a second to supply power to the rectifier tube filament, and a third to supply power to filaments of amplifier tubes. It is obvious that any practical fuse protection arrangement must be capable of opening the circuit whenever any one secondary is shorted.

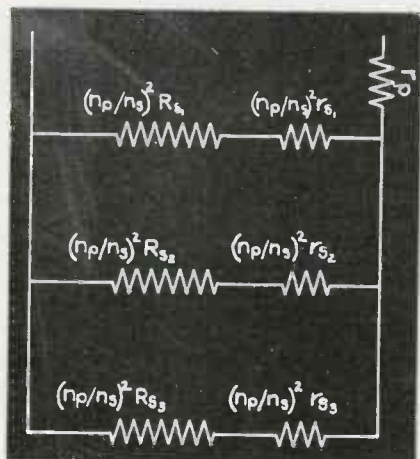

Fig. 5. Equivalent primary with multiple secondaries

The equivalent circuit of such a transformer is given in Fig. 5. Such a multiple secondary transformer will exhibit only a small increase of primary current upon shorting a winding having a power rating proportionately much lower than the other windings. This condition can be shown by studying a typical design.

Primary—125 V at 0.506 amp normal load

Primary winding resistance—12.5 ohms

Sec. No. 1—250 V at 0.05 amp and 250 ohms res.

Sec. No. 2—5 V at 3 amp and .085 ohms res.

Sec. No. 3—6 V at 5 amp and .06 ohms res.

The turns ratio primary to each secondary would be as follows: No. 1, 0.455; No. 2, 22.7; No. 3, 19. The total primary current will be the sum of the components for the

three secondaries: No. 1, .11 amp; No. 2, .132 amp; No. 3, .264 amp, or 0.506 ampere.

Analyzing circuits

Now if the normally loaded transformer were to have Sec. No. 1 shorted, the total primary current would increase to 2.2 amperes, or 4.3 times normal load. However the current in the shorted secondary would increase to 0.85 ampere, or an increase of 17 times. A $\frac{1}{2}$ ampere fuse of the characteristic shown in Fig. 4 would require 17 seconds to open. From Fig. 1, assuming 2250 amp. per square inch, the primary at 4.3 times rated current would require about 40 seconds to reach 50 deg. C rise. In 17 seconds the rise would be approximately 22 deg. C. But the shorted secondary at 17 times rated current will reach 50 deg. C rise in 3 seconds, and in the 17 seconds the rise would be around 300 deg. C and the transformer would very likely be ruined.

In similar manner if the normally loaded transformer were to have Sec. No. 3 shorted, the primary current would increase 7.5 times to 3.8 amperes, and the current in the shorted secondary would increase 13.6 times to 68 amperes. Fig. 4 shows that at 7.5 times rated current the $\frac{1}{2}$ ampere fuse would open in 7 seconds. Referring again to Fig. 1, and assuming a current density of 2250 as before, we find that the primary would require about 14 seconds to reach 50 deg. C rise. As the fuse opens in 7 seconds we would determine the approximate primary

temperature rise to be 25 deg. C. The secondary with a short circuit current 13.6 times normal would reach 50 deg. C rise in about 4.4 seconds and in the 7 seconds the winding rise would increase to about 80 deg. C. The transformer would probably not be seriously damaged before the fuse opened the circuit.

To get full protection

It is apparent that the primary fuse would protect the transformer from damage when the highest power rating secondary was shorted, but would offer no protection when only the high voltage winding was shorted. This is typical of the situation where a transformer has several secondary windings and one of them has a VA rating much lower than any of the others. The only way to protect this low power winding is to place an additional fuse in series with the secondary.

However, if the transformer design engineer is aware that complete fuse protection is required he can increase the conductor size of the low power winding over its normal operation requirement. This will result in higher primary short circuit current, increased thermal capacity of the secondary, a lower normal operating temperature rise of that particular winding, and make fuse protection possible. This is not customary commercial design practice and should be specified when the transformer is ordered. The possibility of complete fuse protection will be obtained at the expense of increased size, weight and cost of the unit.

The Electronic Era

Remember Electronics—the bright new science of America.—Frazier Hunt.

There is always good that comes out of everything. In production know-how, war has advanced the country many years.—Henry Ford.

The biggest thing that's coming out of this war is that we're being jarred out of the ruts. We'll never go back to the old way. Everything that's made will be made better. We'll not shrink back to the old dimensions.—Charles F. Kettering.

To say that broadcasting, and radiotelegraphy, and marine radio, and the design and manufacture of apparatus, went forward side by side is an understatement. They went forward hand in hand, each helping the other over the humps, each exchanging with the others the knowledge gained in practical everyday operation, each pointing out enthusiastically to the others the room beyond, opened by its research.—Gen'l James G. Harbord.

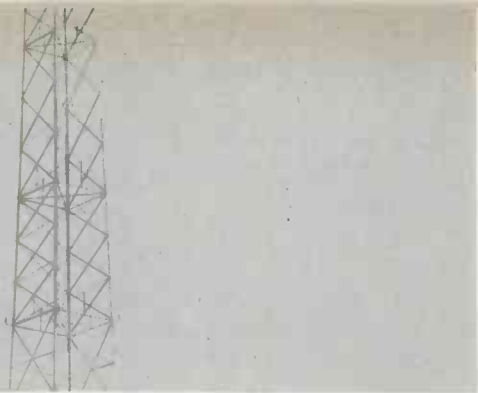

When Engineer is BOSS



WQXR's transmitter house and tower at Maspeth, L. I.

Among the nine hundred broadcasting stations in the United States, WQXR of New York has the distinction of being engineer-owned and engineer-controlled. With its operation and management wholly in highly-qualified engineering hands, the station is an example of what can be achieved under engineering control and supervision that never needs to yield to the vagaries of commercial or advertising men. For at WQXR it is an engineer who is the Big Boss!

Since its inception this station has been of special interest to other radio engineers also because of its high-fidelity operation on a 20-kilocycle channel with enough separation from nearby frequencies to permit really wide-band operation. This frequency assignment at the lower end of the broadcast band, arose from the response accorded early high-fidelity tests made by

John V. L. Hogan, veteran radio engineer, with his experimental station W2XR, to furnish the radio public highest quality recorded music with a cultural background. The subsequent achievement of substantial commercial success, based upon such high technical and musical standards, has called for the application of a high degree of foresight, skill and courage on the part of the organizers of the station.

Maspeth, L. I., site

WQXR operates on a frequency of 1560 cycles from its transmitter and tower located at Maspeth, Long Island, N. Y., with a schedule from 7 A.M. until midnight daily, and on Sunday from 8:30 A.M. to midnight. (Affiliated is FM station W2XQR operating on a frequency of 45.9 megacycles, from 5 P.M. to midnight daily from its own trans-

Station WQXR, New York, owned by John V. L. Hogan, radio pioneer, achieves notable success in high-fidelity transmission of music

mitter atop the Chanin Building on 42nd Street in midtown New York City.)

At the Maspeth, L. I., WQXR transmitter site, a coaxial feed line of about a hundred feet connects the compactly arranged transmitter with the 300-foot tower aerial pictured with this article.

The frequency response of the station is essentially flat from 30 to 12,000 cycles, with an overall harmonic distortion at 1000 cycles of about 1 per cent—using high-level modulation and with hum level exceedingly low. This range is possible because of the absence of interfering signals on adjacent bands in this channel. Substantially, WQXR has been specially designed by Mr. Hogan and his chief as-

Chief Engineer Valentine with Amertran Class B modulation transformer (foreground) and final power amplifier plate reactor



sistant and engineer Russel D. Valentine. A construction permit and call letters W2XR for an experimental television-sound station was granted by the Government to John V. L. Hogan personally in 1929. This was a time when television was just beginning to appear as an interesting outgrowth of sound broadcasting which had occupied the attention of Mr. Hogan during the previous twenty years back to the days when he assisted Dr. Lee deForest in 1906 in early experiments with the newly invented three-element vacuum tube.

Grew from experiment

One day while Hogan was at work in his laboratory trying to synchronize the television of images with sound signals, he desired to co-ordinate the sight of falling water with its sound. Not having sound effects or other means of imitating the fall of water, the idea occurred to use a phonograph record for this purpose and thereupon one was obtained from a neighborhood music shop. Its title was Handel's "Water Music."

The combination of images and music went out, the music on the 1,550-kilocycle channel, a hitherto unused wave band which had been assigned to Mr. Hogan for his experiments. At that time the regular broadcast band ended at 1,500 kilocycles and it was believed that the 1,550-kilocycle mark was far enough removed from the scheduled broad-

cast band to avoid any interference of signals. However, many radio receivers of that day were not so accurately designed or calibrated as those of the present, and many of the sets in use reached beyond the limit of their supposed reception into the unknown region where the unscheduled music was pouring forth. Soon fan mail and reports began to pour into W2XR as other additional music records were added to the list and periodic renditions of them went out over this "off-wave" channel as innumerable image-sound tests were being made. Despite the fact that these initial tests used but 100 watts of power, listeners throughout a wide area from New York City began keeping their receivers dialed to W2XR and depending upon the music of the new station for their daily entertainment, and the flow of fan mail increased in volume and praise of the quality of sound.

Quality the watchword

"Why was the quality then, and why is the quality of the present WQXR so good?" was asked Mr. Hogan in a recent interview.

"Simple," he replied, "Mr. Valentine and I have been very careful of every detail of planning and placing of parts . . . being generous with equipment, often using 'over-size' units in order to prevent the slightest overload of any part, trivial though it may seem. Proper shielding where this is necessary



Rear view of final power amplifier, showing blowers

. . . short leads . . . good grounds . . . operating always within safe limits, and sparing no pains in watching the slightest details are the essentials," continued Mr. Hogan.

Keenly sensitive to every new improvement advanced by the industry and to every new angle observed by them, the station has progressed as changes have been made from time to time.

On December 19, 1933, the Federal Communications Commission assigned channels 1530, 1550 and 1570 as Commissioner T.A.M. Craven then coined the phrase to "high-fidelity" and thus christened Mr.

Control desk. Dark panels house 1-kw auxiliary transmitter. Bright panels—exciter rack, final power amplifier, and modulator rack

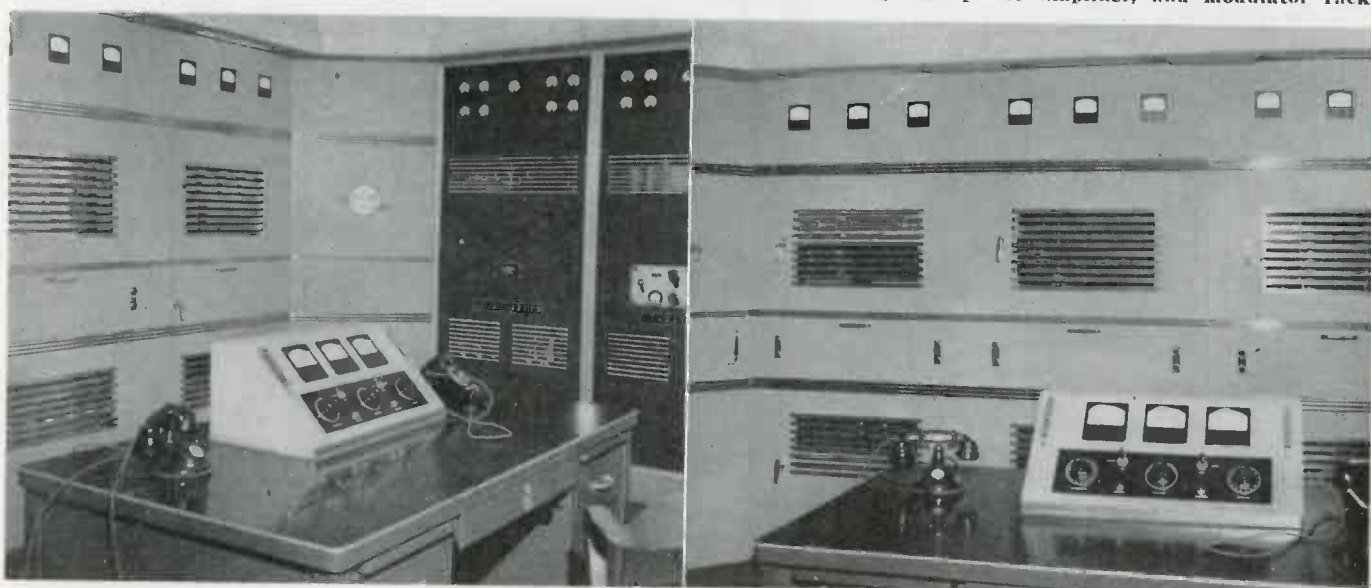

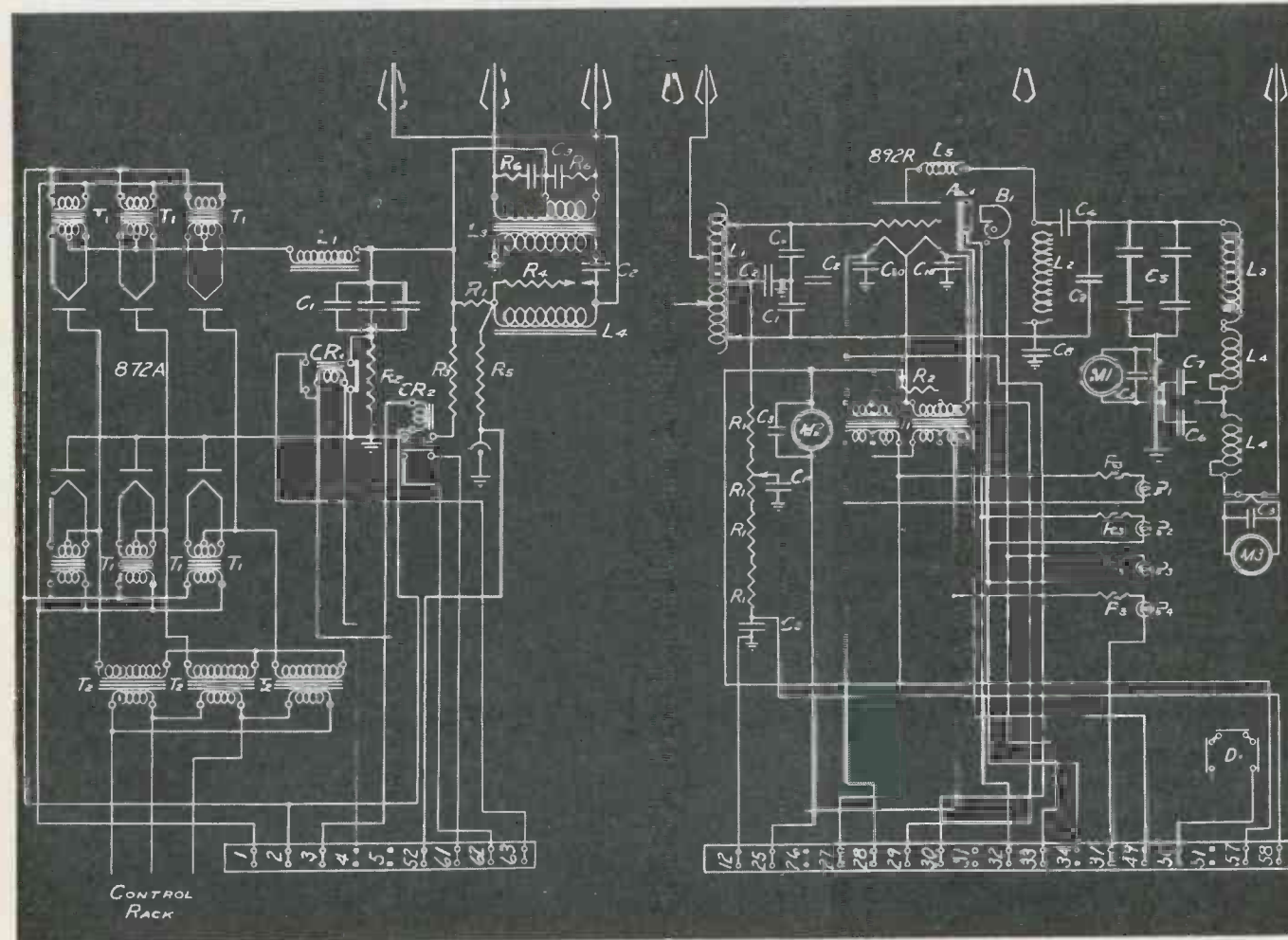
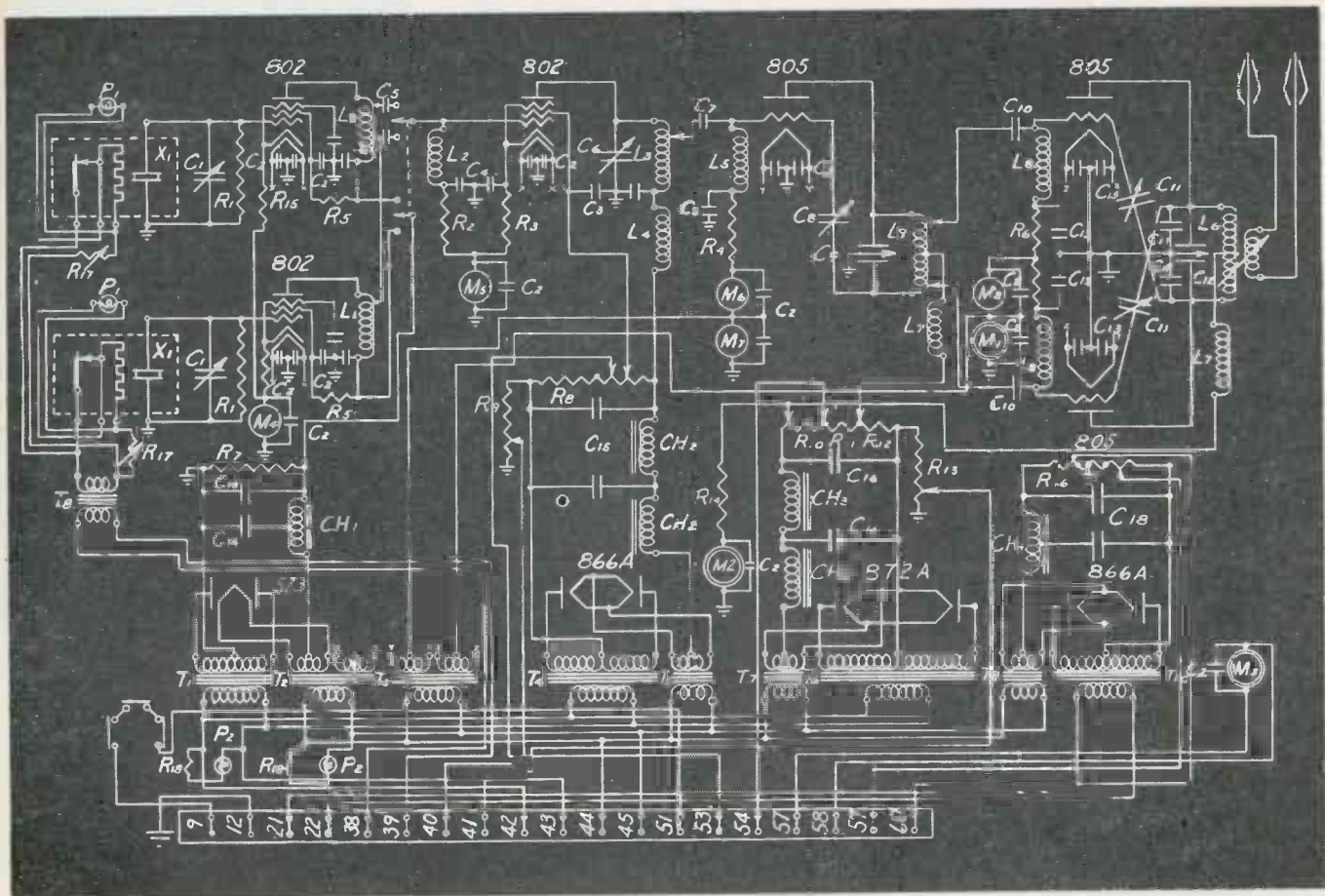

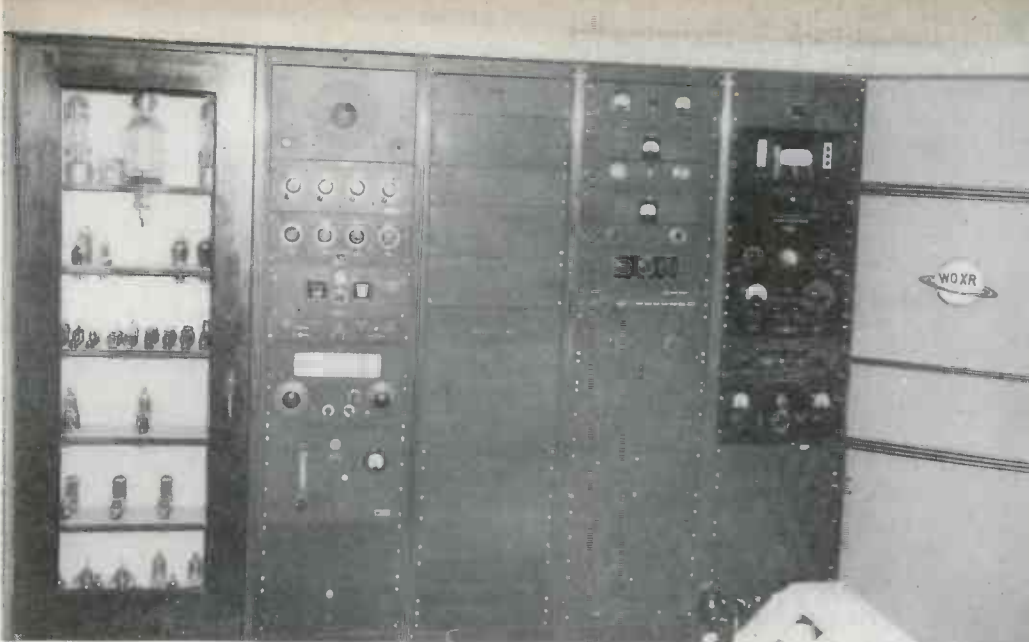

Panels, left to right—Tube cabinet, secondary frequency standard, telephone rack, speech-input equipment, monitoring and measuring. Right-hand photo shows rear view of control rack

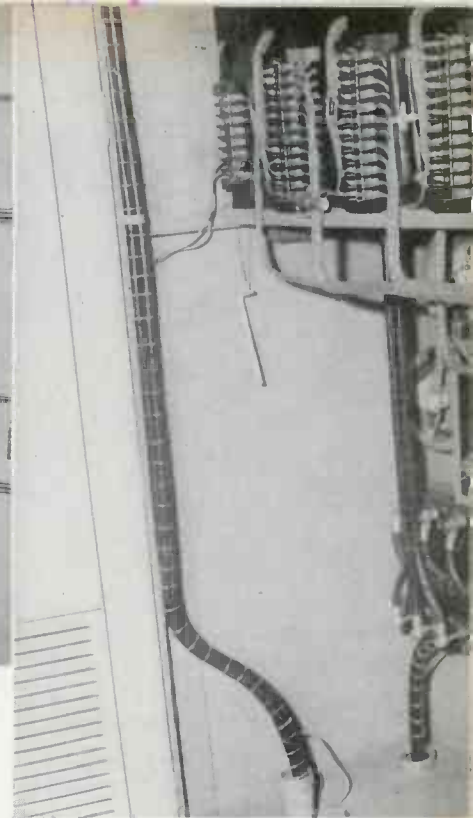

Hogan's experiments. On January 16, 1934, application was filed for permit to build a new "high-fidelity" station . . . hearing was had on April 4, 1934 . . . commission adopted the application favorably on May 18, 1934, then on April 20, 1934, construction permit was granted and two months later the license was received, and on July 2, 1934, official broadcast operations began. On December 3, 1936, the call letters of the station were changed to those of the present, namely WQXR. During the process of these changes the station has advanced in power from 50 watts to 250—500—1000—5000—and 10,000 watts.

Station layout

In the general layout of WQXR transmitter station the grouping of cabinets and panels are compact with clear open arrangements of parts behind or within easy reach on the panels for the purpose of ease and quickness in getting to any parts for repairs or exchange. Two complete transmitters are provided, the main transmitter having an output of ten kilowatts and the auxiliary transmitter rated at one kilowatt. Either may be operated

separately on the regular antenna system. Any change over, due to disruption of the high powered transmitter apparatus or burned out tubes may be made instantaneously and automatically without the slightest interruption of service. Arrangements are also provided for relaying programs through FM transmitter W2XQR on the Chanin Building in case of an emergency breakdown of the telephone lines connecting WQXR studios with the Maspeth transmitter. As far as known this is the only broadcasting station equipped with such precautionary measures. A complete, accurate and automatic system of air raid signal pick up and monitoring with key station WOR is constantly in service and ever on the alert ready for instant action if neces-

sary, prepared to give instant broadcast service if needed.

Owing to the close proximity of LaGuardia airport to the tower antenna and the flying overhead of many airplanes, it is very necessary that the protective flashing lights on the tower function properly and be under constant view of the operator. This is accomplished by means of a small 6-volt red pilot lamp mounted on the control panel which flashes in unison with the two 500-watt red beacon lamps atop the tower, the flashing of which changes at the rate of 40 flashes per minute.

In the operating room at the transmitter, eleven upright panel
(Continued on page 147)

On left-hand page, WQXR circuit diagrams. Top—Exciter unit, lower left—power supply, lower right—power amplifier. On this page, at right, is shown block diagram of WQXR layout

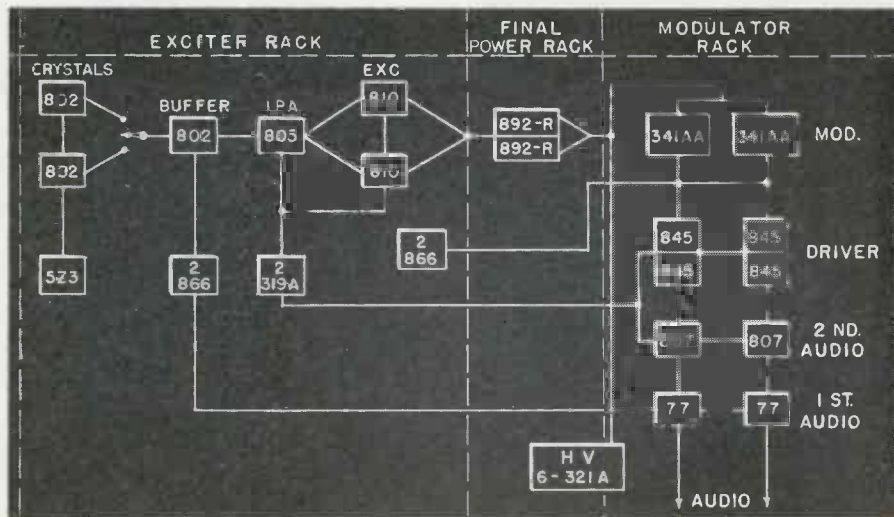

The SELENIUM RECTIFIER

by CAROLE A. CLARKE

Federal Telephone & Radio Corp.

Source of continuous current works satisfactorily in planes at high altitudes and under conditions of severe cold

The introduction of the I. T. & T. selenium rectifier into the United States in 1938 aroused great interest in this device because of its economy, flexibility and general serviceability in converting alternating current to direct current. Further, it possesses the valuable property of operating satisfactorily in airplanes at great heights—conditions under which direct current generators and other rectifiers fail because of the rarefied atmosphere and intense cold. And, fortunately, most of the world's selenium is found in the North American continent in abundance.

The question is often asked, "How does the selenium rectifier operate?" This article answers the question in terms of mechanical analogy and indicates some of the properties and uses of this rectifier.

Direct current

Electricity was applied originally in the form of direct current, such as produced by wet cells comprising a liquid (electrolyte) and pairs of electrodes of different materials. When the electric generator was developed, a commutator was added in order that the current delivered would always flow in the same direction—direct current. Later, alternating current generators and motors came into being, so that in time power companies quite generally furnished consumers only with alternating-current power; hence means were required locally for converting the alternating into direct current. This was accomplished by an alternating-current motor driving a direct current generator or by rectifiers. Some of these latter included chemical solutions or high-speed vibrating parts;

others, vacuum tubes, etc.—all of which have serious drawbacks such as limited life, inefficiency (the introduction of large power losses), causing radio interference, etc. None, including the selenium rectifier are reversible: they convert alternating current to direct current but not the reverse.

Early observations

Early investigators found that current could be established in a continuous loop composed of two different metals by applying heat at one of the junctions. Subsequent observations on the junction of certain metals showed also that for some reason, not completely explained today, current will flow more readily in one direction than in the other. Selenium in one of its various forms and in association with other materials was found to possess this peculiar characteristic but its other properties such as its

light sensitivity, as in selenium cells, long diverted attention from its rectifying action.

Selenium rectifier plate

The selenium rectifier developed by the International Telephone &

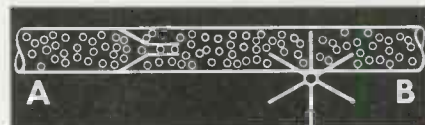

Fig. 2. Mechanical analogy of rectifier operation, shown by marbles in pipe blocked by funnel

Telegraph group of companies in the early nineteen thirties, is a simple device in which the main element is the selenium rectifier plate which performs the actual rectification. As shown in cross-section in Fig. 1, each plate consists of a sturdy metal supporting member, which may be steel or aluminum, coated on one side with selenium with another metallic coating spread over the selenium surface. The result is a sandwich in which the supporting member and the metal coating over the selenium serve to make electrical contact with both surfaces of the selenium. Processing changes the selenium to the form suitable for its service as a rectifier.

Mechanical analogy

Fig. 2 shows a mechanical analogy of the action of a single rectifier plate. If a funnel were fastened in a pipe and marbles of size small enough to go through the funnel were forced in at the end marked A, they would all pass through towards B, thus doing useful work such as turning the blades of a wheel. If, however, marbles were pushed in at end B, they would

Fig. 1. Cross-section of rectifier plate

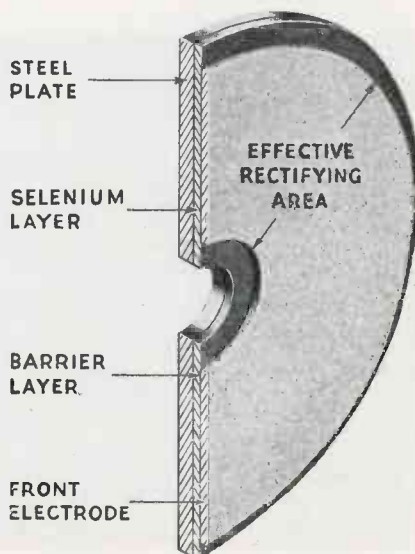

-And How It Operates

jam in the pipe and very few would pass into the small end of the funnel; thus, the wheel would not be rotated.

This is the action of the single selenium-rectifier plate shown in Fig. 1. Electrical current can flow readily from the supporting element through the selenium layer to the front metal contact and then through electrical equipment to do useful work. Flow in the opposite direction is limited to a negligibly small leakage current.

The use of a single rectifier plate in this manner is not a recommended practice. Half the energy of the alternating current would be lost and useful work would result only from that part of the current which flows in the A to B direction.

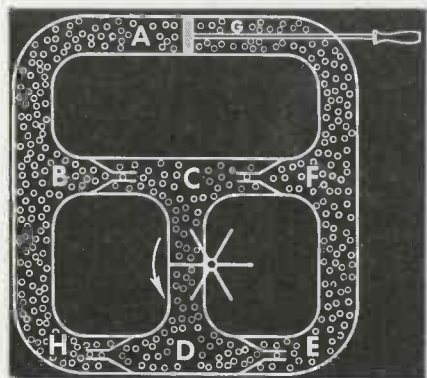

Fig. 3. Mechanical equivalent of four-element rectifier. Oscillating motion at the piston is converted into continuous flow at the paddle wheel

To avoid this loss, several arrangements or combinations of plates are in common use. Fig. 3 shows a mechanical equivalent of one of them. A piston is shown at the top of the figure. Motion of the handle back and forth will cause the marbles in the pipe to move back and forth and simulate an alternating current. When the handle moves towards A, marbles are forced towards B and H but can only pass the funnel at B. Having arrived at C they can only pass towards D, turning the wheel, and thus to E and back up to G. If the handle is then pulled towards G, the action continues. Marbles flow from G to F, thence to C and D, continuing to turn the wheel in the same direction, and return through

H back to A. Reciprocal or alternating movement of the marbles at A and G thus has been converted to continuous motion of marbles in one direction from C to D. Likewise, the selenium rectifier converts the reversals of an alternating current to one which always flows in the same direction.

Advantages

Briefly, the selenium rectifier is a rugged, metallic current-rectifying device capable of withstanding severe shocks and vibration. It does not deteriorate so that long life is assured. It operates instantly in very hot or very cold temperatures and is not affected by high altitudes; it has, in fact, performed normally when subjected to the extreme conditions existing at elevations of 50,000 feet above sea level. High efficiency, good regulation and stable performance are among its outstanding characteristics. Its efficiency is practically constant with changing current demands, and its power loss at no load is negligibly small. There are no moving parts to replace, repair or adjust; also, no chemicals or moving contacts causing radio interference. The rectifier is silent in operation and small in size and weight for its power handling capacity.

A large selection of plates and associated components makes it

practicable to assemble rectifiers for any required voltage and current. Their range is from a few volts to thousands of volts and from milliamperes to thousands of amperes.

Applications

In addition to usefulness in the electroplating field, now particularly important in the case of tin plating because of the shortage of this metal, airplane applications of selenium rectifiers are particularly significant. Their small size, light weight, and ability to withstand rough usage are uniquely advantageous. Their chief attraction in aeronautics, however, is their normal performance at high altitudes where ordinary generators and other rectifiers will not function. For general applications to war products and processes, the fact that selenium rectifiers offer a great saving in vitally needed copper over most other conversion equipment is adding to their ever increasing use.

To enumerate the manifold uses of the selenium rectifier in the communication and power fields, such as in battery charging and as power supply units, would unduly expand this article. For the electroplating industry alone, selenium rectifiers with a total power handling capacity of well over two million watts are in production.

Reference Data for Engineers

Technicians and plant men are often called upon to estimate temperature of glowing filaments and other objects. The chart below will aid in making rough approximations

APPROXIMATE DETERMINATION OF TEMPERATURE BY COLOUR

Dark Red—just visible	900° F.	500° C.
Blood Red	1050° F.	575° C.
Full Red	1375° F.	750° C.
Bright Red	1550° F.	850° C.
Orange	1725° F.	950° C.
Yellow	1825° F.	1000° C.
Yellow—light	1975° F.	1100° C.
White heat	2200° F.	1200° C.
White welding heat	2600° F.	1400° C.
White—dazzling	2800° F.	1500° C.



Left—Complete set-up in master control room

Below—Compact console table used in Studios B, C and D

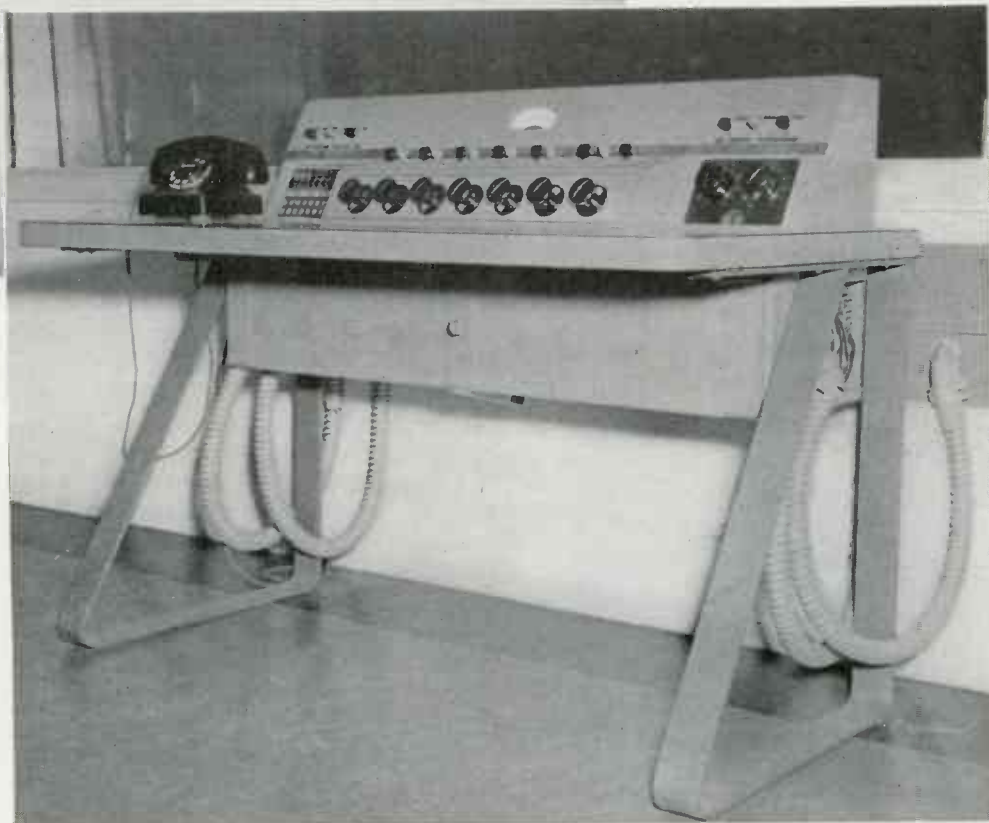

WIBG's "Stop- Look & Listen" STUDIO

by FRANK E. BUTLER

The planning of a new broadcast-station layout is now dependent on what can be done to convert existing parts and equipment into a system that will provide the quality and reliability standards the broadcast industry of this country has fostered. Not everything can be done now that might be desired, because of material restrictions.

It is of interest, therefore, to examine the details of one of the last completely engineered stations that was finished before this ban was made effective.

When the owners and designers planned the transmitter and studio equipment of WIBG broadcasting station in down-town Philadelphia, they recognized the trend toward frequency-modulation and higher fidelity of transmission and were able to prepare for these features

in their studio apparatus. Advantage was also taken of the unusual location to provide the innovation of popularizing the technical aspects of broadcasting by installing a ground-floor studio and control room where passersby on the busy street can "stop, look and listen" to a broadcast program being put on the air.

Western Electric 23-C type consoles were selected for the control rooms of B, C and D studios. Each of these consoles employs eight low-level inputs and two output lines. The new Western Electric 25-A console which is shown, is used in WIBG's master control console and also in control room A. This console provides a complete intercommunication system to all control rooms, to the transmitter, throughout the studio building, as

well as private lines to the local telephone company. Next in line on this console board is an order-wire panel which is used to communicate with all of the remote broadcast points associated with the station.

Pre-set panel

The principal feature of the console is the pre-set panel. With this arrangement an operator may set up a program in advance. Upon the receipt of a proper signal, all that is necessary, is to press one switch to make a complete program change. This console is also equipped with four VU meters which are on the four normal outgoing lines. There is also a test VU meter which enables the operator to check the level of any studio control room and also any

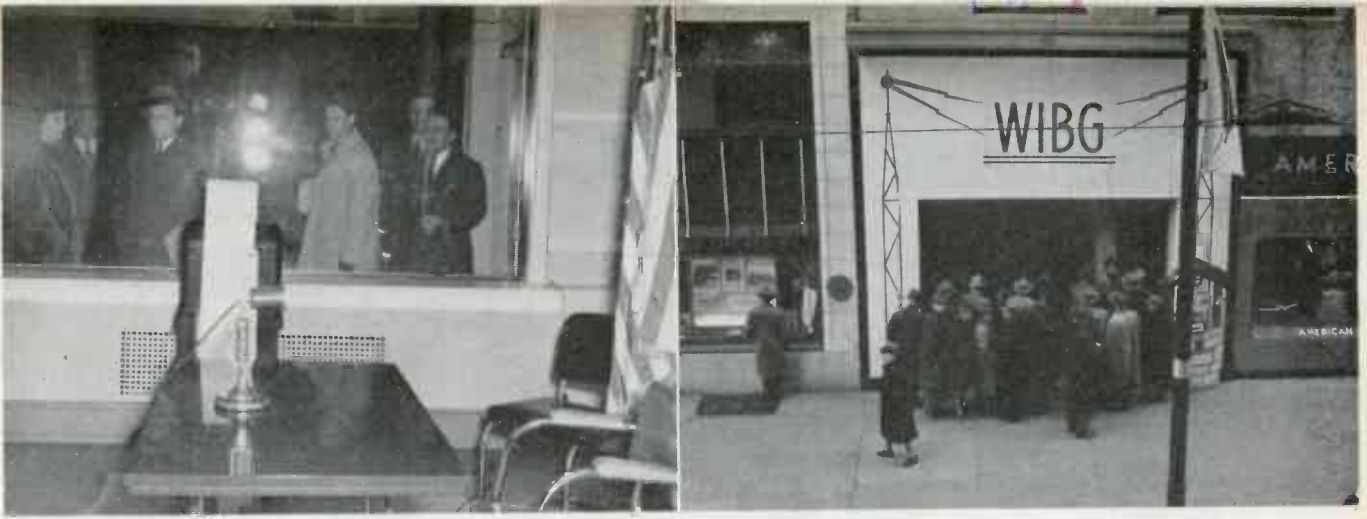

Studio on ground floor facing the street, and sidewalk audience watching a broadcast

remote broadcast before it is going on the air.

Also used here is a special cue selector panel, built by the staff engineers. By using this equipment the operator in charge is able to monitor all circuits in the building in addition to any other incoming line to the master control. The Western Electric 25-A console is used in the master control to take care of low level circuits such as those that might originate in Studio C. By the use of relays, the low level circuits from Studio C may be switched from control room C console to the 25-A console in master control, so as to be able to put on transcribed "spots" during station breaks and to handle all-night record programs.

There are also five racks in master control which contain six Western Electric 106-A amplifiers which feed the six out-going lines. Eight Western Electric 120-B isola-

tion amplifiers are used to feed the monitor circuits which run throughout the building. Three Western Electric 124-E amplifiers are used to feed the audition room, the lobby and the extra monitor in master control. All telephone lines also terminate in the racks, in addition to the line equalizers.

30 to 15,000 cycles

Due to the high fidelity of the installation, 30 to 15,000 cycles, special care had to be taken in regard to wiring and suitable "ground" conditions in order not to pick up stray noises and hum. The lines running between master and studio control rooms are made up of Graybar type GB-211 coaxial cable. This is a single conductor cable with a braided shield and a rubber insulation overall, grounded only at the receiving end. A special "ground" was installed in master control consisting of a four-inch

copper bus bar running from a common ground terminal to the basement where it is attached direct to the city water mains. There is a special ground strip which runs from a common terminal in master control to each of the other control rooms.

In order to make the entire installation more flexible, each studio control room is equipped to handle "remotes" in addition to master control. If, in the event the master control is tied up with one or more programs and a "remote" is coming up, the operator can assign another control room to take the "remote."

WIBG's monitoring system is made up of sixteen pairs of lead-covered cable running from master control to each control room and studio, in addition to all the offices and lounges attached to the station. At each monitoring point a selector switch is installed with a

(Continued on page 149)

Schematic diagram of signal circuit, Station WIBG, Philadelphia

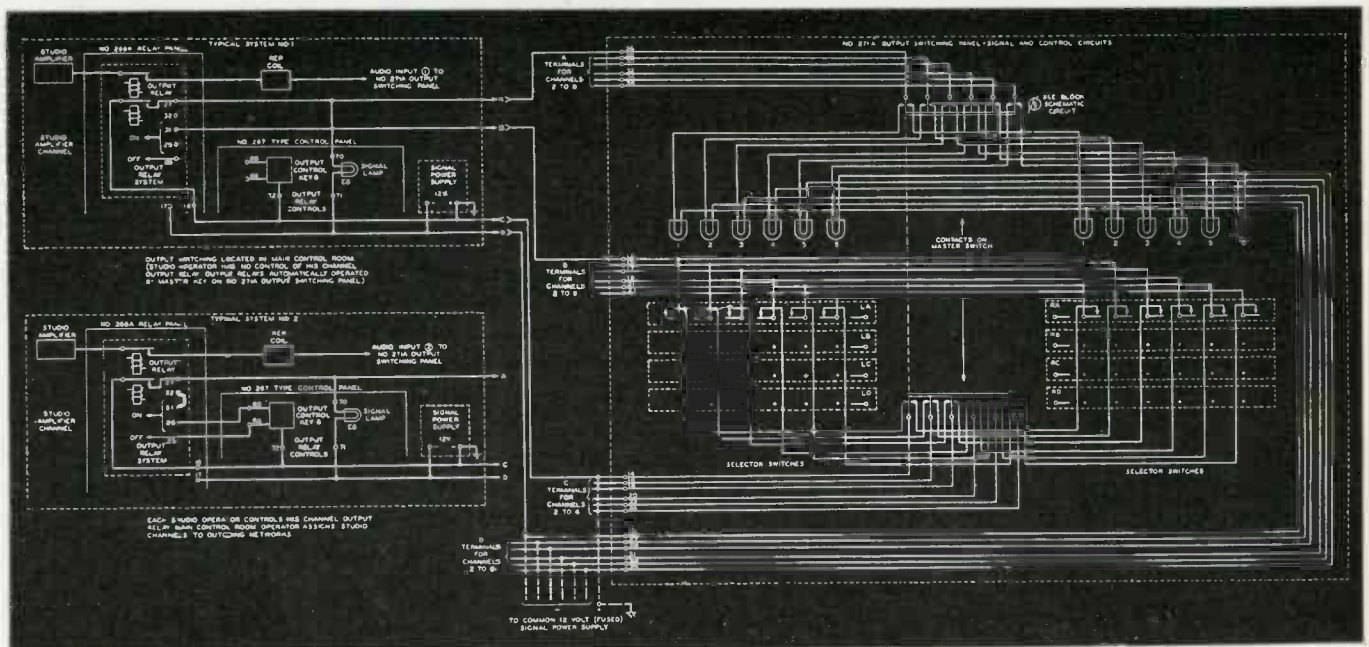

BC OPERATING METHODS

Wartime economies when men, materials and supplies are scarce



Infra-red photo-cell beam guards station grounds

Protecting Transmitters Against Sabotage

Broadcast-station engineers are now being called upon to supervise protective installations surrounding their transmitters, which are usually located in remote areas. Some have installed infra-red photocell alarms like that pictured. Acoustic fence alarms are another recent development. One station has a floodlight, loudspeaker and microphone at the gate half a mile from the station, so visitors can be given a thorough questioning before nearing vital plant equipment.

Training FM Operators

"Within recent weeks it has twice been my duty to train a new technician to operate a frequency-modulation broadcast station," says L. B. Keim, engineer manager of FM station W47NY. "Of course this training process followed the selection of a likely candidate from among several applicants. In each instance a novice was selected, rather than someone who has had amplitude broadcasting experience, as the technique involved is so basically different.

"At W47NY the operator on duty serves alone for about 25 per cent of the time, thus is responsible for the transmitter as well as audio facilities. Rather than swamp a new man with complex instruction

books on equipment operating as provided by the manufacturers of the several devices involved, I found it extremely advantageous to prepare in outline a step-by-step procedure, together with a time schedule for carrying out the several tasks. This was supplemented with a clearly concise description of the purpose and operation of each piece of equipment involved, and how to handle and set each of the several controls on each device.

"These two sets of instructions were provided the operator before he came on duty for the first time, and it was found necessary only to show him how the controls functioned once, before he was really quite at ease with the equipment operation.

New man learns quickly

"Following several days of actual operation, the theory of the several sections of equipment was explained to the new technician, and the proper maintenance procedure, together with fundamental trouble shooting was started. In both instances I have not found it necessary to go over any point more than twice for a full comprehension of what was wanted or desirable for the proper operation of the equipment.

"All too frequently the instruction books provided by the makers of broadcast equipment forget the

essential fact that operators are new to both the equipment involved, and also the technic in question. Because of the dynamic range of volume possible with frequency modulation it is preferable to train a new man rather than to try to break the technic of the A M broadcaster, wherein there is a constant "riding" of gain, rather than setting a level and allowing the free play of volume variation to be presented to the listener.

"Because it is so hard to acquaint one who is accustomed to this constant surveillance of the level involved, I prefer training a man who is green to the art, feeling that in the long run he will be a more proficient operator for this system of entertainment presentation."

Precautions to Prolong Tube Life

Productive capacity of tube manufacturers is today being taxed to the utmost. The limited supply of vital materials in turn creates grave difficulties for the technical staffs of broadcasting stations having the responsibility of keeping their stations on the air regardless of obstacles, hardships or scarcity of supplies.

So whatever the broadcasting engineer is able to do to prolong the life of his transmission tubes and at the same time keep the station operating at top-notch efficiency, will not only relieve his own peace-of-mind but will eventually contribute a definite service to his listening audience. Now, more than ever the responsible engineer must study tube peculiarities and learn how best to care for them so as to prolong their life or add to their efficiency. Many engineers are aware of the different factors governing the action and ills of their radio tubes, although there are probably others who have not had the opportunity to intimately study these characteristics.

By knowing the causes of premature tube failure, such mishaps

could be removed in advance if the broadcasting engineer made it a part of his duty to know more about his tubes and applied the best-known practices which effectively add to tube life. He should have knowledge of the best methods of juggling both filament and plate voltages—what residual gases, if any, are in certain types of tubes before or after protracted usage—the heating and cooling principles of such tubes, and even the fatigue limits and characteristics of the plates and other parts within the tube. Much of this special information may be obtained from the tube manufacturer, who will gladly supply such information to the engineer upon request.

The simple rules for the proper handling of these several types of tubes and the best way of insuring their long life can be briefly outlined, as follows:

Tungsten-filament types

The filament voltage of these tubes should be maintained as low as possible, even to the point where the output spills over on the fringe of slight distortion. It has been found that filament voltage when reduced about five per cent below rated voltage often doubles the life of the tube,—in much the way that operating the filament that same percentage above normal cuts its life nearly one half. The plate voltage should be raised in easy gradual stages and maintained at as low plate consumption as possible, consistent with efficiency. By carefully tuning the transmitter, anode dissipation is greatly reduced.

If the amplifier supplies direct current to the filaments, the leads to each tube should be alternated at least every five or six hundred hours, or once each week. If this is not done there will be a greater thinning on one side of the filament than on the other which will result in premature failure or weakening of the tube's efficiency. With water-cooled tubes distilled water should always be provided, in order to reduce scale formation on the anode.

Air-cooling

If air-cooled tubes are used, a plentiful supply of cool air should be maintained from an electric fan, either swing-mounted or rubber

cushioned so as not to cause vibration of any of the tubes in the transmission panel. Place the blast of air so that it will strike the spot where the glass joins the metal, or the leads go through, thus reducing electrolysis on the metal or gas evolutions through the pores of the glass. To prevent hot-spotting or gassing of tubes keep a plentiful supply of water flowing over the water-cooled anodes or a strong blast of air on the air-cooled anodes.

It must not be forgotten that lowered filament voltage also effects a lessened supply of electron emission. It will also decrease the full modulation in the antenna current and this may in turn decrease the radiated distance or modify the quality of reception; hence a close check on this should be kept so as not to alter the station's idealistic operation to any great degree.

Thoriated-tungsten types

In the operation of these tubes be very careful not to overload them. To guard against this, a fuse or other form of adequate protec-

tive device should be used. Keep all of these tubes well ventilated by the use of electric fans that are so mounted as to eliminate vibration of the tubes in the transmission panel. Operate these tubes at the lowest possible anode current and voltage. Tune the transmitter slowly and carefully so as to minimize plate dissipation. Avoid overloads because they are liable to evaporate the thorium surface from the filament and permanently injure the tube.

Filament voltage

Thoriated tubes rated at 250 watts or higher, when operated only intermittently should be kept at a filament voltage of 80 per cent of normal during standby periods of less than two hours. This allows the cathode surface to be replenished so that its service is instantly available when resumption of service is desired and the filament voltage raised to the required level for working efficiency. If the circuit is inoperative for a longer period than two hours the filament and all other currents should be turned off.

Announcers Check Up Own Delivery



At Station WHO, Des Moines, Iowa, a microphone which records on a magnetic tape, is set up in the announcers' room. As each announcer comes on duty, he reads his commercial copy into the instrument and then listens to the immediate playback, to observe faults in enunciation which can be corrected on the air

SURVEY of WIDE READING

Electronic news in the world's press. Review of engineering, scientific and industrial journals, here and abroad

Voltage Regulator

H. W. Dietert & M. F. Hasler (Journal of the Optical Society of America, Jan. 1943)

The voltage regulator shown is intended to control the voltage for a densitometer lamp to ± 0.07 per cent. This is obtained by the use of two transformers, one stepping up the voltage above the required value, the other one stepping down, a compensating lamp, a regulating lamp and several electron tubes.

UHF Antenna Radiation Pattern

S. S. Baneryee & G. C. Neogi (Indian Journal of Physics, Calcutta, Aug. 1942)

Space distributions of radiation from horizontal transmitting antennas are computed by integrating the retarded scalar and vector potentials of the corresponding electro-magnetic fields. Quarter-, half-, three-quarter and one wavelength antennas are considered, and it is stated that the equations may be used for any multiple of a quarter wavelength. The calculated values are shown diagrammatically and in tables. The polar diagram of a quarter-wavelength antenna would consist of concentric circles, the field being independent of angular position with respect to the direction of the antenna. Its variation with distance is given.

For experimental verification of the results, a modulated oscillator of the Hartley type was used and a super-regenerative receiver was built. Three to seven meter waves were investigated.

Polar diagrams of radiation for three-quarter, one-half, and one wavelength horizontal antennas, respectively

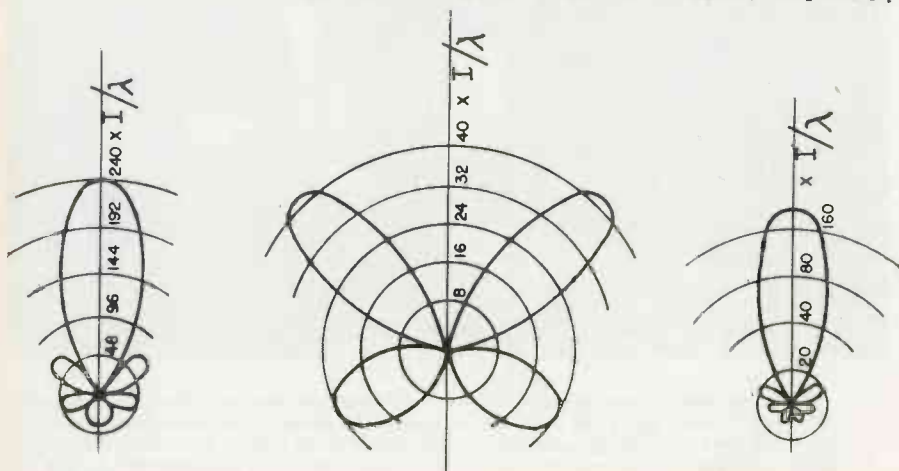

Velocity Distribution of Field-Emission Electrons

Richter (Zeitschrift fuer Physik, Berlin, Sept. 8, 1942)

The above article, reported in the February 1943 issue of the Wireless Engineer, deals with the velocity distribution of electrons emitted by cold metals in a vacuum and under the influence of high electric fields. The velocity distributions normal and tangential to the emitting surface are derived from field-emission theory. The results are compared with available experimental values. It is pointed out that the deviations are probably due to field distortions in the experimental arrangement, and various possible distortions are discussed.

Frequency-Comparison Circuit

G. H. Rawcliffe (Journal of the Institution of Electrical Engineers, Part III, London, Vol. 89, No. 8)

A smaller electric force of higher frequency and a larger electric force of lower frequency are divided into two components in phase quadrature, one component from each source being then applied to the horizontal electrostatic deflection plates and one component from each source to the vertical electrostatic deflection plates of a cathode-ray oscillograph. A suitable circuit is illustrated and described. The pattern thus obtained is a circle with inwardly or outwardly turned re-entrant loops for counter rotation or similar rotation, respectively.

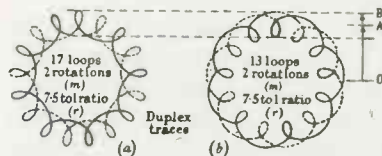

-Stationary traces produced where mf/f_1 is integral

$$\left(\frac{T \pm m}{m} = r = \frac{f_2}{f_1} \right)$$

(a) Counter rotations.
 (b) Similar rotations.
 Dotted section for clarity only: lines actually continuous.

Frequency comparison circuit

For stationary patterns, if $T =$ number of loops, the frequency ratio is given by the expression $(T \pm m)/m$, where m is the degree of multiplicity or the number of rotations required until the initial point is reached again. In the example illustrated, the multiplicity is two.

If the higher frequency is not an exact integral multiple either of the lower frequency or of a small integral fraction thereof, a pattern will be formed which drifts bodily round the screen. It is deduced that the frequency ratio then equals $(T \pm m)/m - pT/mf$, $2\pi p$ being the angular drift velocity and f the lower frequency; positive and negative signs correspond to inwardly and outwardly turned loops, respectively.

Tuning FM Receivers

J. A. Rodgers (IRE Proceedings, March 1943)

For accurate tuning, indication of zero voltage at the discriminator output is required. The problem is that the tuning eye does not, usually, indicate zero voltage, and several ways to obtain this object are described.

One method is to put the positive and negative discriminator voltages through special circuits so that they will each produce a voltage in the same direction. Such a circuit, including a double diode and a double triode, is described. A special indicator tube, equivalent to a dual triode and eye tube, is proposed.

Measuring Small Electrical Charges

R. M. Showers (Review of Scientific Instruments, Feb. 1943)

Though constructed for the measurement of ionization of air produced by X-rays, the apparatus shown may be used for other purposes involving the determination

The 92 Elements — Atomic Data for X-Ray Work

Compiled from current literature by St. John X-Ray Service, Inc., 30-20 Thomson Avenue, Long Island City, N. Y., which has been a pioneer in industrial radiography, this table lists the elements, with complete atomic data and X-ray characteristics.

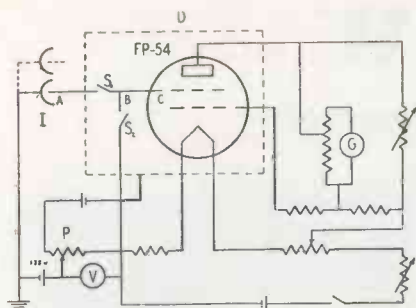

Measuring small electrical charges

of electric charges of 1.5×10^{-11} coulomb with a probable error of one per cent. The difference in potential across voltmeter V, for the same plate current indicated by galvanometer G, before and after ionization has taken place in chamber I, measures the potential drop in the chamber. Provided the capacitance of the system ABC to shield D is known, the charge transfer caused by ionization may be computed. Prevention of errors due to floating of the grid during part of the procedure is discussed, and the detailed construction developed to provide necessary shielding is described.

Principles of Micro-Wave Radio

E. V. Condon (Reviews of Modern Physics, Vol. 14, No. 4)

Originally intended as a text book, the article gives an extensive survey of the problems involved, the mathematical solutions and their physical meaning. The first two chapters, contained in this issue, deal with cavity resonators and transmission lines, respectively.

Based on Maxwell's electromagnetic field theory, a short account of which is given at the beginning, the possible frequencies and the corresponding modes of oscillation in a rectangular cavity resonator are derived. General expressions for the electric and magnetic field energy, for zero charge everywhere in the cavity and then for finite charge distribution, are computed.

Electric modes and magnetic modes in cylindrical resonators of arbitrary cross-section, including hollow cylinders, are studied, as well as resonators in the form of figures of revolution, with the special case of a quarter-wave coaxial resonator. The theory of the modes of oscillations of spherical resonators is given.

In the second chapter, the characteristic impedance of a two-conductor transmission line is introduced, voltage and current distribution are considered and the effects of a load are explained. Impedance matching and losses in the line are treated.

Symbol	Atomic Number	Name of Element	Atomic Weight	Melting Point °C	Boiling Point °C	Valence	Density	Crystal Structure	Lattice constant a	Constant b	Wave-Length c, μ	Critical K α in A.U.
H	1	Hydrogen	1.0080	-259	-252.8	1	.08375	H				
He	2	Helium	4.003	-271	268.6	0	.1664					
Li	3	Lithium	6.940	186	1400	1	.534	Bc	3.51			
Be	4	Beryllium	9.02	1350		2	1.85	Hc	2.268		3.594	115.7
B	5	Boron	10.82	2303	2500	3	2.3	H				67.71
C	6	Carbon	12.010	3500	3500	4	1.88	amorphous				
		Diamond						Tc	3.56			44.448
		Graphite						H	2.46		6.78	
N	7	Nitrogen	14.008	-210.5	-195	3.5	1.165	Bc	5.67			31.557
O	8	Oxygen	16.000	-218	-182.7	2	1.332	O				23.567
F	9	Fluorine	19.00	-223	-187	1	1.13					18.275
Ne	10	Neon	20.183	-253	-239	0	.8387	Fc				
Na	11	Sodium	22.997	97.5	880	1	.97	Bc	4.30		5.99	11.885
Mg	12	Magnesium	24.32	651	1120	2	1.74	Hc	3.202			9.6775
Al	13	Aluminum	26.97	659.7	1800	3	2.70	Fc	4.0413			8.3194
Si	14	Silicon	28.06	1420	690	4	2.42	Tc	5.42			7.10917
P	15	Phosphorus	30.98	44.2	288	3.5	1.82	H	yellow			6.14171
		black						Rh	5.14; 34.7'			
		red						Bc	31.04			
S	16	Sulfur	32.05	112.8	444.7	2, 4, 6	2.07	R	10.48	12.92	24.55	5.36375
				119.3			1.96	M	26.4		12.32	2.81
Cl	17	Chlorine	35.457	-40	-33.6	1	1.9	R				4.72136
Ar	18	Argon	39.944	-189.6	-186.1	0	1.66	Fc	5.43			3.5495
K	19	Potassium	39.096	62.3	760	1	.85	Bc	5.333			3.73706
Ca	20	Calcium	40.08	810		2	1.55	Fc	5.56			3.35495
Sc	21	Scandium	45.10	1200		3	2.5					3.0284
Ti	22	Titanium	47.90	1850		4	4.5	Hc	2.953	4.729		2.74681
V	23	Vanadium	50.95	1780		3.5	5.68	Bc	3.01			2.50213
Cr	24	Chromium	52.01	1615	2200	2.3, 6	7.14	Bc	2.8787			2.28917
Mn	25	Manganese	54.93	1230	1900	2.3, 7	7.44	Bc	6.903			2.10149
Fe	26	Iron	55.85	1530	2450	2.3	7.87	Bc	2.861(a)			1.936012
Co	27	Cobalt	58.94	1480		2.3	8.9	Hc	2.507	4.072		1.78919
Ni	28	Nickel	58.69	1452		2.3	8.9	Fc	3.5175			1.65835
Cu	29	Copper	63.57	1083	2310	1.2	8.94	Fc	3.608			1.54116
Zn	30	Zinc	65.38	419.4	930	2	7.14	Hc	2.6589	4.9349		1.43587
Ga	31	Gallium	69.72	30.1		3	5.91	O	4.5167	4.5107	7.6448	1.34087
Ge	32	Germanium	72.60	958	1350	4	5.36	Tc	5.647			1.25521
As	33	Arsenic	74.91	820	615.1	3.5	5.73	Rh	4.151; 53.49'			1.17743
Se	34	Selenium	78.96	217	690	2.4, 6	4.81	Hc	4.337	4.944		1.10652
Er	35	Bromine	79.916	-7.2	61.1	1	3.12	R				1.04166
Kr	36	Krypton	83.7	-169	-151.7	0	3.488	Fc	5.69; 88.8'			.9821
Rb	37	Rubidium	85.48	38.5	696	1	1.53	Bc	5.62			.92776
Sr	38	Strontium	87.63	900		2	2.6	Fc	6.075			.87761
Y	39	Yttrium	88.92	1490	2500	3	5.51	Hc	3.663	5.814		.83132
Zr	40	Zirconium	91.22	2350		4	6.4	Bc	3.61			.78851
Cb	41	Columbium	92.91	1950		5	8.57	Bc	3.299			.74889
Mo	42	Molybdenum	95.95	2535	3620	4, 6, 10, 2	10.2	Bc	3.1403			.712105
Ma	43	Massium	97.8	2300		2, 3, 7		H				.675
Ru	44	Ruthenium	101.7	2450		6, 8, 12, 2	12.2	Hc	2.698	4.274		.64806
Rh	45	Rhodium	102.91	1950	2500	3	12.44	Fc	3.7957			.6137
Pd	46	Palladium	106.7	1549	2540	2, 4	12.00	Fc	3.8823			.58653
Ag	47	Silver	107.880	960.5	1955	1	10.5	Fc	4.0774			.56267
Cd	48	Cadmium	112.41	320.9	778	2	8.65	Hc	2.973	5.606		.53832
In	49	Indium	114.76	155		3	7.3	Fc	4.583	4.936		.51548
Sn	50	Tin	118.70	231.9	2270	2, 4	7.30	Bt	5.8194	3.1753		.49402
Sb	51	Antimony	121.76	630.5	1440	3.5	6.2	Rh	4.5; 57.6'			.47387
Te	52	Tellurium	127.61	451	1390	2.4, 6	6.24	H	4.445	5.962		.45491
I	53	Iodine	126.92	-113.5	200	1	4.93	Fc	4.791	7.248	9.771	.43703
Xe	54	Xenon	131.3	-109.1	-109.1	0	5.495	Fc	6.24; 88.8'			.417
Cs	55	Cesium	132.91	26	670	1	1.90	Bc	6.05			.40411
Ba	56	Barium	137.36	850	950	2	3.5	Bc	5.015			.38899
La	57	Lanthanum	138.92	826		3	6.15	Hc	3.75	6.06		.37466
Ce	58	Cerium	140.13	840		3, 4	6.90	Fc	5.143			.36110
Pr	59	Praseodymium	140.92	940		3	6.63	Hc	3.657	5.924		.34805
Nd	60	Neodymium	144.27	840		3	7.05	Hc	3.65	5.88		.33595
Eu	61	Eurpium	144.50			3						.31302
Gd	62	Gadolinium	150.43	1350		3	7.7					.30265
Tb	63	Terbium	158.9			3						.29261
Dy	64	Dysprosium	162.5			3						.28286
Ho	65	Holmium	164.9			3						.27375
Er	66	Erbium	167.2	1250		3	4.73	Hc	3.74	6.0v		.26499
Tm	67	Thulium	168.9			3						.25664
Yb	68	Ytterbium	173.04	1800		3						.24861
Lu	69	Lutecium	174.99			3						.24098
Hf	70	Hafnium	178.6	1700		4	11.4	Hc	3.20	5.07		.2358
Ta	71	Tantalum	180.88	2910		5	16.6	Bc	3.296			.22973
W	72	Tungsten	183.92	3400		6	19.3	Bc	3.1583			.21337
Re	73	Rhenium	186.31	3000		7	20.0	Hc	2.7553	4.4493		.20131
Os	74	Osmium	190.2	2700		6, 8	22.48 (a)	Hc	2.724	4.314		.19550
Ir	75	Iridium	193.1	2454		4	22.4	Fc	3.8312			.19004
Pt	76	Platinum	195.23	1755	3910	2, 4	21.47	Fc	3.9158			.18483
Au	77	Gold	197.2	1063	2500	1.3	19.32	Fc	4.07	4.936		.17466
Hg	80	Mercury	200.61	-38.85	357.25	1.2	13.55	R	2.999; 70.32'			.17004
Tl	81	Thallium	204.39	301.7	1280	1.3	11.85	Hc	3.45	5.52		.16525
Pb	82	Lead	207.21	327	1525	2.4	11.34	Fc	4.9389			.15625
Bi	83	Bismuth	209.00	271.3	1436	3.5	9.78	Rh	4.736; 57.16'			.14171
Po	84	Polonium	210.0	1800		2.4, 6		M	7.42	4.29	14.10	
At	85	Astatine	221.0			8						
Rn	86	Radon	222.0	-113		0	4.40					
Fr	87	Francium	223.0			1						
Ra	88	Radium	226.0	960		2	5.0					
Ac	89	Actinium	227.0	1800		3						
Th	90	Thorium	232.0	1842		4	11.5	Fc	5.077			.1368
Pa	91	Protactinium	231.0			5						.109
U	92	Uranium	238.0	1690		4, 6	18.7	M	2.829	3.308		.13095

Symbol	Atomic Number	Name of Element	Atomic Weight	Melting Point °C	Boiling Point °C	Valence	Density	Crystal Structure	Lattice constant a	Constant b	Wave-Length c, μ	Critical K α in A.U.
* Abbreviations of Crystal Structure												
Bc	Body-centered Cubic											
Hc	Hexagonal Close-packed											
Rh	Rhomboidal Hexagonal											
Bt	Body-centered Tetragonal											
Fc	Face-centered Cubic											
Ft	Face-centered Tetragonal											
T	Tetragonal											
Tc	Tetrahedral Cubic											
H	Hexagonal											
M	Monoclinic											
O	Orthorhombic											
R	Rhomboidal											

WHAT'S NEW

Devices, products and materials the manufacturers offer



Induction Heating Units

The Van Norman Machine Tool Co., Springfield, Mass., announces two new spark-gap induction heating units for surface hardening, brazing, soldering and other heating applications requiring localized heat. These completely enclosed units are available in two sizes, 16 kw. and 32 kw. The entire heating operation is automatic and workers can readily learn to operate the machines.

Plastic Indicator

A hairline indicator consisting of a fine line engraved on a small sheet of Vinylite plastic, ink filled, is announced by Printloid Inc., 93 Mercer St., New York. Made in widths as narrow as 1/1000th of an inch or heavier it can be held accurately to the required dimensions.

Electrical Fault Limiter

The Burndy Electrical Fault Limiter is designed to protect aircraft and other electrical circuits against damage from short circuit conditions. The fault limiter does not clear ordinary overloads, but will carry its nominal current rating indefinitely. However, when fault currents in the order of four to five

times rated current are encountered, this unit will clear promptly. Particularly useful for protection on generator circuits and for bus sectionalizing, it is normally installed in series with the reverse current relay. In case the reverse current relay fails to operate, it will clear the circuit, thereby preventing fires and the spreading of the fault. Manufactured by Burndy Engineering Co., Inc., 459 E. 133 St., New York.

Molded Plastic Insulation Tester

"Megger" instruments for testing electrical insulation resistance of the hand-generator and direct-reading ohmmeter type are announced by James G. Biddle Co., 1211-13 Arch St., Philadelphia. The



plastic case is molded of high-impact phenolic material by the Chicago Molded Products Co. of Chicago. The testers are used for detecting and preventing trouble in all types of electrical equipment—power, communication, radio, industrial and railway.

Balanced Armature Relay

Cook Electrical Co., 2700 Southport Ave., Chicago, manufacturers of products for communications, aircraft and industrial applications, has just introduced the Balanced Armature Relay. This relay is a double action interlocking control unit with balanced armature control. It can be "tailor made" to fit into designs where its light weight and small size are essential. It is ruggedly built to withstand the constant vibration and sudden shocks of mobile applications. Available in various contact arrange-

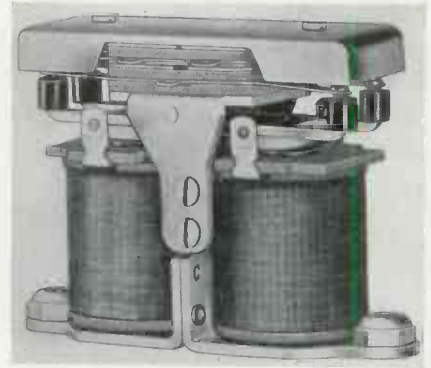

ments or with Micro Switches in place of spring pile-ups. Capacities up to 5 amperes, 110 volts ac rating; coil capacity 10,000 ohms each; contact forms or assemblies up to 12 springs on each side. 2 3/4 in. long by 1-15/16 in. high by 7/8 in. deep.

Frequency Meters

Model 100-A Low Frequency Standard and Model 500-A Electronic Frequency Meter have been announced by the Hewlett-Packard Co., 395 Page Mill Rd., Palo Alto, Calif. Model 100-A provides a convenient source of standard frequencies from 100 cps to 100 kc, and consists of a crystal controlled oscillator and a series of frequency dividers of the regenerative modulator type. Model 500-A is designed to measure the frequency of an alternating voltage from 0 to 50 kc. It consists of a wide band amplifier with a limiting circuit and electronic switch, a constant current supply, a frequency discriminating circuit and an output meter and rectifier.

Indicator Operates by Reflected Light

"Signalette," a signal indicator operated by reflected light and radio activity is manufactured by Littelfuse, Inc., 4757 Ravenswood Ave., Chicago. Houses a solenoid, the armature of which is connected with the "butterfly" indication vanes by a simple lever hookup. The fluorescent "butterfly" opens instantly to show signals, reflecting the proper indicating light. "Butterflies" are furnished in red, amber and green. When not indicating Signalette is black. Length overall, 2-5/32 in. and is available for mounting in panels up to 3/8 in. thickness.

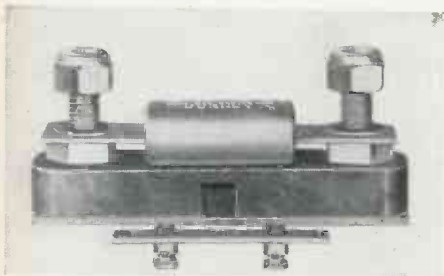

Selenium Rectifier

A new rectifier which protects against excessive humidity and moisture conditions, encountered particularly in marine service, has been announced by the Federal Telephone and Radio Corp., Newark, N. J. This has been made possible by a special assembly which lends itself more readily to moisture proofing. The standard petal-shaped brass contact washer and pressure-limiting fiber washer are not used. Instead a single metal washer is employed, making it possible to apply the protective coating to all exposed surfaces.

Photoelectric Controls

Series 70, photo-controls, is developed by United Cinephone Corp., Torrington, Conn., to simplify control problems with resultant increase in speed, accuracy and man-hour economy. The housing is



equipped with cork gaskets fixed to the hinged covers, maintaining the units impervious to moisture, dust or weather. Life expectancies range as follows: light source bulbs to 2000 hours, amplifier tubes (6J5) to 3500 hours, photocell tubes to 10,000 hours and practically indefinite life for other components.

Throat Microphone

An improved Throat Microphone is offered by the Miles Reproducer Company, Inc., of 812 Broadway, New York, for use in aircraft, submarines, military tanks, defense plants and in all other places which are very noisy. Placed around the neck over the larynx (or voice box), the words spoken by the wearer are picked up and may be amplified and transmitted through a public address system. Used with any standard amplifier designed for a crystal or other high impedance

microphone. The microphone is constructed on the inductor-dynamic principle, is rugged and compact and weighs only 2 oz. It is leather covered and equipped with an adjustable neck strap.



Transmitter-Receiver

The TR-4 radiotelephone and receiver unit is used for fixed station operation or as a mobile unit in an automobile, truck, boat or plane, or anywhere a 6 volt battery or 110 volts 60 cycles ac is available. Incorporates a separate receiver using Hytron HY-615 as the super-regenerative detector and a separate transmitter utilizing an HY-75 as an ultra-high frequency oscillator. The detector operates at approximately 20 to 25 v. and cuts down receiver radiation to a minimum. Manufactured by Abbott Instrument, Inc., 8 W. 18th St., New York.

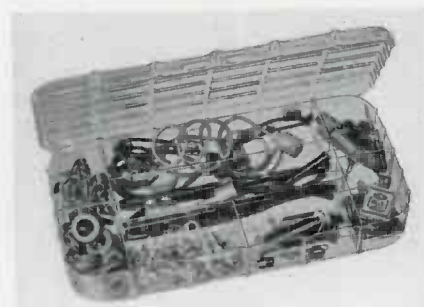

Transparent Utility Box

A series of transparent Pyra-Shell boxes developed by the Utility Box Division of the Shoe Form Co. Inc., Auburn, N. Y., are being used to great advantage where vital

A News Service for Readers

Announcements of new products which appear on these pages are prepared by the editors as a service to our readers, and are published as news, without any advertising consideration whatever.

small parts are necessary on the production line. Containing 1 to 36 compartments as required, the boxes assure great saving in time where it is necessary to quickly locate particular items.

High Voltage Plate Supply Transformer

An armored-insulation high voltage plate supply transformer has just been developed by the Acme Electric & Mfg. Co., Cuba, N. Y., to overcome the effects of high voltage aging. Rated at 3300 volts, 1.8 amperes secondary, the transformer is used for transmitter service for dc rectifier systems. Special emphasis is placed on the adaptation of its insulation to continuous radio transmission service.

New Light Weight Thyatron Tube

Designed for applications where weight and space must be considered, a new thyatron tube with both a control and a shield grid for control applications, has been announced by the tube division of the General Electric Electronics Dept., at Schenectady, N. Y., Designated as the GL-502, the new tube is a little over two and one-half inches long, weighs about two ounces, is inert-gas-filled and of all-metal construction. Applications for the new tube will be found in industrial welding and any general control equipment.



No. 3 Blower

The L-R Mfg. Co., Torrington, Conn., announces its No. 3 blower which is similar to its No. 2 blower with greater output. The wheel is Turbo type, 3 in. in diameter where zinc plated, 1/2 in. or 5/16 in. shaft bore with two Allen set screws at 90 deg. angle in hub. Housing is molded of high impact plastic, cable of withstanding 100 deg. C. Housing and wheel weigh but 12 ounces.

NEW PATENTS ISSUED

Summaries of inventions relating to electronic uses

Note: Date application was Filed shown by (F). Date patent Issued, (I). For the reader's convenience, patents most recently issued are presented first.

Photoelectric Burglar Alarm—

The photoelectric cell, an amplifier and an oscillator tube are operated by the power line which also serves to transmit the signal to a remote place where it is detected and actuates an indicator. Photoelectric cell amplifier and oscillator are so connected that oscillation occurs only upon interruption of the light beam striking the photocell. F. H. Shepard, (F) Nov. 7, 1939, (I) Feb. 23, 1943, No. 2,312,127.

Inverse Feedback—

Inverse feedback of audio potentials into the detector circuit causes a decrease in percentage modulation and in distortion encountered in the detector circuit. Degenerative audio potentials may alternatively be applied to one of the amplifiers preceding the detector. The invention is claimed in connection with diversity systems to reduce distortion due to fading. M. G. Crosby, RCA, (F) Dec. 16, 1941, (I) Feb. 23, 1943, No. 2,312,080.

Crystal-Stabilized FM —

Automatic frequency control potentials are derived by means of piezo crystal 54 and diodes 58 and 60 to be applied to grid 14 of reactance tube 10. Tube 20 is the oscillator. The crystal discriminator has a straight frequency-voltage characteristic by virtue of the capacity couplings in the holder. In this way over- and under-neutralized crystal filter characteristics are produced. Variable capacities C_1 and C_2 may be

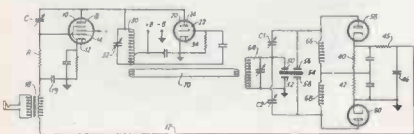

required to supplement the holder capacities and provide control. The time-constant filter comprising resistance 45 and capacity 46 allows only the slow variations of the mean frequency of the frequency modulated oscillator output energy to pass a voltage to lead 17, and thus removes the detected modulation potentials. Another embodiment showing a three-electrode crystal is also described. M. G. Crosby, RCA, (F) Sept. 6, 1940 (I) Feb. 23, 1943, No. 2,312,079.

Television Shading Control—

It is intended to compensate for variations in average value of the picture signal the wave form of which has been noticed to remain relatively constant for any particular transmitting tube. According to the invention, the compensating voltages are derived from deflection tubes 18 and 73. The output of tube 30, providing for the vertical compensating voltage, may be controlled as to its intensity by the position of contact 28 and the duration of the variation may be controlled by altering the bias through contact 44, the tube working at the

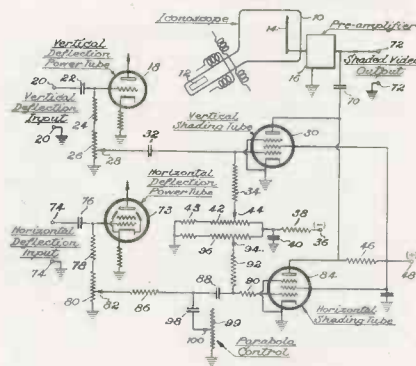

non-linear part of its characteristic. Thus a continuous change in the shading wave form may be accomplished. A similar arrangement including tube 84 and taps 82 and 92 is provided for the horizontal shading correction. In this circuit, the sawtooth waves derived from deflection tube 73 can be distorted by adjustment of contact 100. A similar control may be inserted in the vertical compensating circuit. O. H. Schade, RCA, (F) Sept. 30, 1941, Feb. 23, 1943, No. 2,312,054.

HF Loop Antenna—

An aircraft antenna is proposed with comparatively little sleet formation at voltage maximum points, and having a substantially circular radiation pattern or a pattern elongated in the direction of the longitudinal axis of the aircraft. To provide at least three current maxima in the circumference of the antenna, three or more acting radiating members are arranged to form a closed periphery. By thus distributing the current more equally, a nearly circular radiation pattern is obtained. The members are capacitatively coupled, in some instances by overlapping of the respective members. By adjusting the coupling

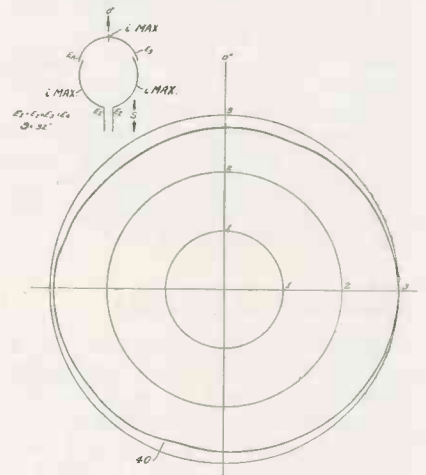

capacities between the members, the current maxima may be shifted causing variations in the pattern. In the figure, 40 denotes a radiation pattern experimentally determined for the structure shown. M. A. Rote, Federal Telephone & Radio Corp., (F) April 12, 1941, (I) Feb. 23, 1943, No. 2,311,872.

Vertical Crossover Elimination—

With an arrangement of five similar non-directive antennas, four disposed at the corners of a square and one in the center of the square, radio beacons may be generated by continuously feeding the center antenna and alternately feeding the two pairs of oppositely arranged antennas. However, it was found that errors in the course occur when the vertical angle of the airplane to the array becomes at all steep. These errors were traced back to radiation caused by reflection of the non-energized pair of antennas. Elimination of this disturbing effect is obtained by detuning the effective lengths of the non-energized antennas while the other antennas are being fed. Various arrangements to accomplish this object are described. A. G. Kandoian, Federal Telephone and Radio Corp., (F) July 26, 1941, (I) Feb. 23, 1943, No. 2,311,837.

Amplifier-Detector Tube —

It was established that the average voltage of a suppressor grid may be made negative to a considerable extent without much impairing the characteristics of the tube. It is therefore feasible to use the cathode-suppressor-grid circuit as a diode rectifier, in addition to another function of the multi-elec-



DEDICATES *the* **PRESENT**
to **PRESERVATION** *of the* **FUTURE**

HYTRON'S SOLE PURPOSE for the duration is to maintain an always-increasing flow of tubes into the radio and electronic equipment which is playing a vital part in winning this Radio War. It is our firm conviction that the torch of Liberty which Hytron is helping to keep burning will light the way to the unconditional surrender of our enemies and to an electronic age which will amaze a freed world.



HYTRON CORP., Salem and Newburyport, Mass.

... Manufacturers of Radio Tubes Since 1921 ...



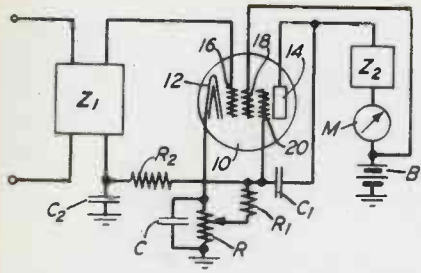

trode tube. In the amplitude indicating meter shown, the slide for R_1 provides adjustable direct current bias for the suppressor grid to delay the action of the detector until a preassigned input signal amplitude has been attained. The resistance condenser network C_1 , R_1 forms a grid-leak condenser combination. Upon conventional amplification, the signal is applied to suppressor grid through condenser C_2 and is rectified by the suppressor-grid-cathode diode. The resultant direct current potential developed across resistance R_1 is fed back to the control grid through resistance R_2 , causing an increased negative grid potential which, in turn, reduces the space current indicated by the meter M . Several stages may be effectively coupled, preceding stages taking over the rectifying function upon saturation of the following stage. Several other applications of the inventive idea are illustrated and described. F. B. Anderson, Bell Telephone Labs., (F) Aug. 10, 1940, (I) Feb. 23, 1943, No. 2,311,807.

Phase Modulation—A magnetic harmonic generator, which produces a large number of harmonics of nearly constant amplitude, is used for phase modulation. A variable bias current from the source Q is impressed on the non-linear magnetic coil L of the generator, and as a result the timing of the peaks is shifted forward or backward from normal position by an amount approximately proportional to the instantaneous value of the biasing current. However, the wave form obtained is not a true phase modulation, but may be transformed into one, e.g., by the insertion of rectifier R . Various modifications are described. Obviously, the phase-modulated wave can be transformed into a frequency-

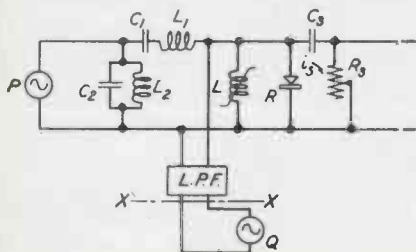

modulated one. This may be accomplished by introducing a loss device at the line X—X which gives a loss to the signal proportional to its frequency. L. R. Wrathal, Bell Telephone Labs., (F) Aug. 27, 1940, (I) Feb. 23, 1943, No. 2,311,796.

Tuning Indicator—An auxiliary grid 24 surrounds part 26 of the cathode extending inside fluorescent electrode 15, and is electrically connected with the cathode. The wires of the auxiliary grid have a diameter of about five mils or less so as not to cast a shadow on the fluorescent electrode. It is the purpose of electrode 24 to make the electron current to electrodes 22

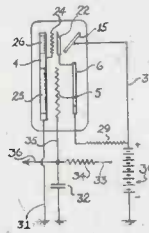

and 15 independent of the number of electrons emitted, which latter varies considerably with the age of the tube. Further, it provides for a more even distribution of the electron current should different portions of electrode 26 emit unequally. J. D. LeVan, Raytheon Production Corp., (F) Aug. 6, 1937, (I) Feb. 23, 1943, No. 2,311,672.

Directive Antenna—The antenna consists of a straight conductor L and discs S of high dielectric constant through which the conductor extends. The discs are spaced a half-wavelength apart, and intended to provide phase reversal. For this purpose their thickness is

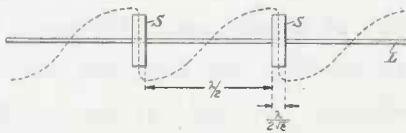

made $\gamma/2e^{1/2}$, as this will be a half-wavelength in the dielectric. The conductor sections oscillating in the discs are so short that their radiation does not contribute much to the field which is that of aligned dipoles, a half-wavelength long and energized in phase, as used heretofore. J. Goldmann, C. Lorenz Ag., (F) Oct. 10, 1941, (I) Feb. 16, 1943, No. 2,311,535.

UHF Hand Transmitter—Two oscillator tubes 19 and 21 are arranged in a shielding shell 1. Their cathode circuits may be tuned by moving conductive bar 31 thus changing the effective length of tubular members 27 and 25 in the

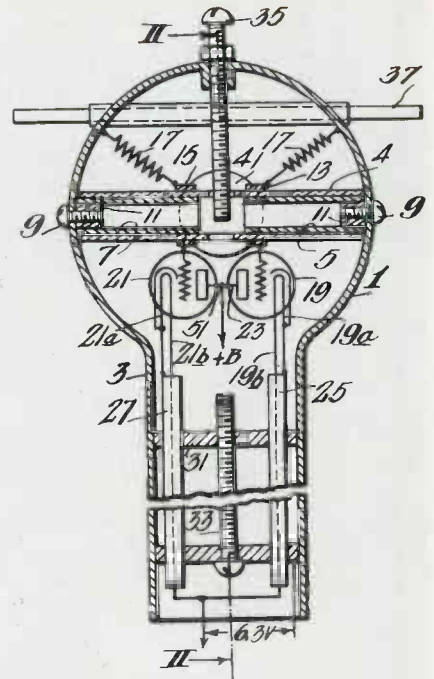

cathode circuit. The grid circuits may be tuned by means of the inductance of the shielding member 1 and the capacity between armatures 5 and 7. Rods 37 serve as antenna. The oscillations generated may be frequency modulated by means of a metallic membrane mounted close to the adjacent ends of the armatures 5 and 7, and varying the capacity there between. For amplitude modulation, a button microphone may be included and suitably connected to the grids of the oscillator tubes. A. H. Turner, RCA, (F) July 31, 1941, (I) Feb. 16, 1943, No. 2,311,491.

Television Transmitter—The video signal amplitude-modulates the carrier, while the synchronizing signal frequency-modulates the carrier. The controllable oscillator is, alternately, controlled by a frequency stabilizer unit and a frequency shifter unit to obtain the desired behavior of the carrier.

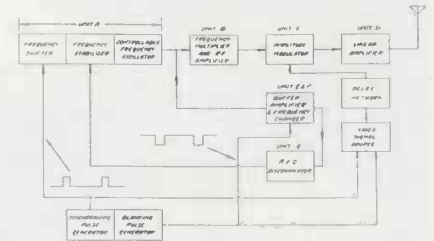

Several embodiments of different parts of the arrangement are described. A conventional receiver, due to its frequency-response characteristic, will amplify the synchronizing signal to a greater extent than the video signal. D. B. Smith, Philco Radio & Television Corp., (F) July 8, 1941, (I) Feb. 9, 1943, No. 2,310,324.

THE MARVELOUS LAMP



from Genie to Electron

● The fantasy of Aladdin's marvelous genie-commanding lamp—first conceived by the unknown author of "The Arabian Nights' Entertainments"—comes true in the cathode ray tube of today. And there are practical advantages in electrons over genii in modern life and work—in television, for example.

We go back to Aladdin's lamp, because Sylvania has specialized as a maker of

marvelous lamps—and electronic tubes. First it was the incandescent lamp.

Then, in the early days of radio, we put the incandescent "Edison Effect" to work in electronic tubes.

Having attained an electronic reputation in radio research and tube manufacture, Sylvania applied this experience to the making of better artificial light as a fluorescent lamp pioneer.

In our forty years of experience, it has been a far cry from the original incandescent lamp to today's many electronic devices, which have far more possibilities than ever after a year of global war.

Today Sylvania aspires to serve the radio and electronic industries, whose wider destiny is being written in American laboratories, as a supplier of electronic tubes with hundreds of envisioned uses. Ours will be in the role of maker of these marvelous tubes—yours, their application to new products for better life and work in the peace to come.

MAKER OF ELECTRONIC TUBES FOR INDUSTRY



SYLVANIA

ELECTRIC PRODUCTS INC.

Emporium, Pa.

Incandescent Lamps, Fluorescent Lamps and Fixtures, Radio Tubes, Electronic Devices

STUPAKOFF

FOUNDED IN 1897

Ceramics for the World of Electronics

Dependable Ceramic Insulators

for the Radio Industry

THE name "Stupakoff" is not new to the radio industry. Two decades ago special ceramics were developed in the Stupakoff Laboratories, and by 1930 we were producing over a million ceramic parts daily for radio tubes.

Today Stupakoff produces a complete line of precision made, "radio grade" insulators, made of Steatite and other materials. All Stupakoff ceramic insulators are subjected to the most severe laboratory and field tests, to assure their unfailing performance in actual service.

For the duration, our entire ceramic manufacturing facilities are devoted to the production of Stupakoff ceramic insulators for equipment used to bring Victory to the United Nations.

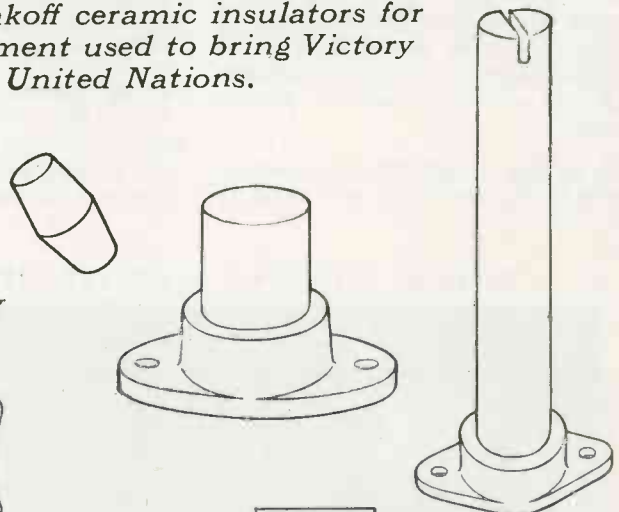
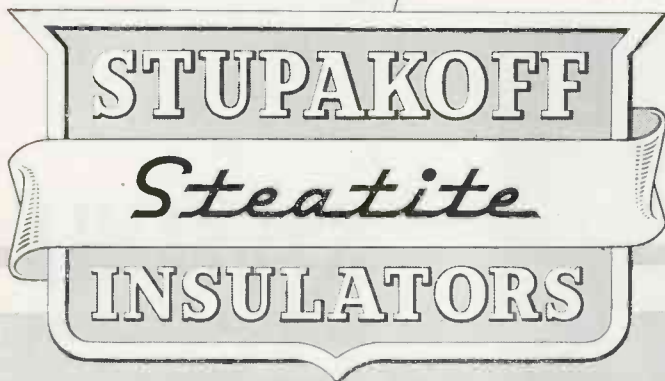
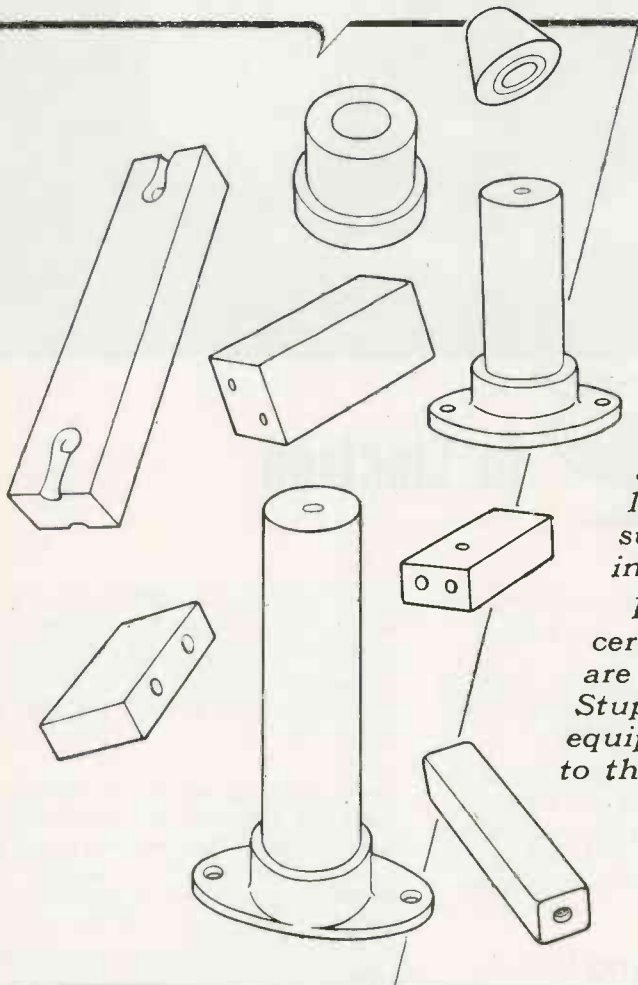

STUPAKOFF CERAMIC AND MANUFACTURING CO., LATROBE, PA.

LATEST

NEWS FROM WASHINGTON

Concerning the Electronic Industries



ARMY AND NAVY "AHEAD OF PARADE" IN SUBCONTRACTING — The Army (Signal Corps) and the Navy (Radio Division of Bureau of Ships) have been ahead of the parade in the wide distribution and subcontracting of electronic and radio equipment procurement. Before Pearl Harbor, these two branches of the armed services planned for the wide dissemination of procurement contracts and conversion of many types of industry into radio manufacturing. That they have been able — aided by the WPB Radio Division — to superimpose their five-billion-dollar procurement goal of this year upon the radio manufacturing industry, over twenty times its peacetime production, demonstrated their farsightedness and careful planning. If the advocates of subcontracting would "stop, look and listen", however, they might realize that too-wide distribution of procurement may mean waste in manpower and tooling, and that probably the process of subcontracting has now gone as far as is desirable.

MORE THAN 60% OF SIGNAL CORPS PROCUREMENT SUBCONTRACTED — The Army Signal Corps was far in the forefront in Washington in the distribution of contracts to small companies and at present has approximately 25,000 prime contracts and between an estimated 400,000 and 500,000 subcontracts outstanding. This is on the basis of \$3,600,000,000 of communications equipment contracts now being performed. Early in the fall of 1941, three months before Pearl Harbor, the Signal Corps inaugurated its program of distributing contracts and subcontracting to firms numbering in the thousands — this was long before the pressure grew in Washington for the distribution of war production to small businesses. It is estimated that more than 60% of the Signal Corps procurement is subcontracted.

NAVY JOINS IN SUBCONTRACTING — The Radio Division of the Navy's Bureau of Ships has likewise performed a very notable achievement in the distribution of its electronic procurement among a large number of manufacturers in line with the policy of subcontracting. The Navy has nearly 100 prime contractors and around a score of major subcontractors and several thousand subcontractors and suppliers dealing directly with the manufacturers building complete equipments. More than \$900,000,000 of contracts are now outstanding from the Navy Radio Division. Many of the Navy's present prime contractors were brought into the production picture as subcontractors until they had become familiar with Navy specifications, procurement methods, inspection requirements, etc., and as soon as they had proved their ability to manufacture equipment to meet the Navy's needs they were given prime contracts for similar equipment. This process is now continuing.

DETERMINE BEST COMPANY FOR MANUFACTURING — The radio business, in peace times a \$250,000,000 industry (at factory selling prices), had to be converted over night by the Signal Corps and Navy. While the larger radio manufacturing companies had the engineering skill and "know how" and were used for the complicated apparatus, the Signal Corps utilized a wide variety of industries to accomplish its vast procurement task. These included manufacturers of pinball machines and "juke boxes", makers of refrigerators, typewriters, vacuum cleaners, electric fans, porcelain products and eyeglass manufacturers, the latter being enlisted to assemble quartz crystals for use in military radio transmitters. For the most part the smaller companies have been engaged in making components and parts for assembly into the complete radio apparatus. The Signal Corps determines the best company and place for the award of radio procurement contracts through a purchase committee, composed of representatives of its three field procurement districts and of the WPB, sitting in Washington at the War Department to analyze contract awards so as to try to prevent the overloading of any individual company.

BOTTLENECKS CHANGE ALMOST DAILY — The bottlenecks of the gigantic electronic production program for the war change speedily — as soon as one is cured another crops up. Today manpower appears the major problem even more than materials, and before the end of 1943 is likely to be much more serious as the draft deferments of key and skilled personnel are terminated in face of the demands of the armed services' quotas. A recent illustration of this fluctuation was steatite, a critical short material a few months ago now changed to a virtual oversupply. Now the WPB is urging electronic manufacturers who designed away from steatite because of its scarcity, to go back to that material. Steatite bodies have lower loss factors and are generally superior to glass and plastic substitutes. In fact, new applications are now being studied for use of steatite in strips and even mechanical parts.



Rear Admiral S. C. Hooper,
"Father of Navy Radio"

Admiral Hooper Retires —Will Work on Post- War Plans

Admiral S. C. Hooper, known as the "Father of U. S. Navy Radio," retired from naval service March 15th, and plans to act as counsellor to radio and electronic manufacturers in preparing for post-war development.

"I want to see a happy electronic industry," said Admiral Hooper, "proud of its achievements, and keeping step to victory, and for the future good of all. As the industry has done so much for the Navy, and for me personally, I plan to devote the immediate future to assisting it in every way possible, not only in the present war effort, but in preparing for post-war conditions.

Keep industry prosperous

"The industry must be maintained in prosperous shape. The solid foundations which led to our present efficiency must be preserved, reviewed and improved. New applications will be available to the public when war developments are released. The industry must reorganize itself to this end in a true American way, without waiting for the government to take the initiative. One strong prop is to maintain the sacredness of patents, without which there can be no stability or insurance of incentive to progress. With so many new patents evolving from War developments and so few remaining old unexpired patents, now is the opportunity for the electronic industry itself, as a whole, to bring about a patent exchange arrangement un-

der which patents will be owned by and available to all the industry and research workers on a fair and far-sighted basis.

"Also, through cooperation with the Government," said Admiral Hooper, "readiness for war production must be maintained so that the lag in shifting from peace to war status will be eliminated if war comes again. This includes factory facilities, tools, trained personnel, systems for obtaining materials, and many other items."

Distinguished career

On August 16, 1912, then Lt. Hooper became the first Radio Officer of the Fleet. In 1915 he was assigned charge of the radio division of the Bureau of Engineering. During this period, many of the Navy's high power radio stations were constructed under his direction. In 1918 he returned to the radio division and constructed the Navy's radio direction-finder system. In 1923 during a cruise to Australia he made the high-frequency experiments which led to the adoption of short wave by the Navy. In 1927 he assisted the Federal Radio Commission as technical adviser in charge of engineering, and later served as director of Naval Communication.

Admiral Hooper has received the Navy Cross for distinguished service, the Mexican Service Medal, the Victory Medal, American Defense Service Medal, the Legion of Honor of France, and the Gold Medal of the Institute of Radio Engineers.

His home address is 72 Spier Drive, South Orange, N. J.

Conventions and Meetings Ahead

Radio Club of America (11 West 42nd Street, New York), April 8, Columbia University, New York.

American Institute of Electrical Engineers (H. H. Henline, 29 West 39th Street, New York), District Technical Meetings, April 8-9, Pittsfield, Mass., and April 28-30, Kansas City, Mo.; National Technical Meeting, June 21-25, Cleveland, Ohio.

Electrochemical Society (Colin G. Fink, Columbia University, New York), April 7-10, Hotel Roosevelt, Pittsburgh.

American Mathematical Society, April 23-24, New York, Chicago and Stamford University, California.

Society for Measurement and Control, New York Section Meeting, April 27, New York.

American Chemical Society (Alden H. Emery, 1155 Sixteenth Street, N.W., Washington), April 12-16, Indianapolis.

National Electrical Manufacturers Association (W. J. Donald, 155 East 44th Street, New York), Spring Meeting, April 19-23, Chicago; Annual Meeting, Oct. 25-29, Waldorf-Astoria Hotel, New York.

American Society of Mechanical Engineers (Ernest Hartford, 29 West 39th Street, New York), Spring Meeting, April 26-28, Davenport, Iowa.

Society of Motion Picture Engineers (Sylvan Harris, Hotel Pennsylvania, New York), May 4-6, Hotel Pennsylvania, New York.

American Institute of Chemical Engineers (50 East 41st Street, New York), May 10-11, New York.

Acoustical Society of America (Wallace Waterfall, 120 South LaSalle Street, Chicago), May, New York.

American Society for Testing Materials, June 28-July 2, Pittsburgh.

Associated Police Communication Officers, Inc. (Buffalo, New York), July, Buffalo, New York.

American Welding Society (Miss M. M. Kelly, 29 West 39th Street, New York), Oct. 18-21, Chicago.

"History of Recording" at N. Y. Science Museum

An exhibition of early recording and phonographic devices is now on display in the New York Museum of Science and Industry, Rockefeller Center, New York City. An outgrowth of the WOR program, "Wax Museum" which presents records popular many decades ago, records which have now become curios and collectors' items; the Science Museum exhibit now provides a visual history of recording from its earliest times to the present, through the cooperation of RCA-Victor, Columbia Records, Decca Records, and the United States Army. The recording companies have loaned priceless historical equipment to the exhibit, including the hand-made Bell and Taintor graphophone made in Washington in 1885; the U. S. Army brings the exhibit right up to the moment by lending for display the machine which enables our troops all over the world to listen to the latest recordings, as well as the special records prepared by the Army itself.

RCA-Victor's contribution to the exhibit consists of one of the first recording machines of the spring-wind type built by Victor in 1912, a display showing the steps in making a record, an early Victor phonograph, a photographic exhibit of the record scrap drive, and a picture story contrasting early and present recording.

Columbia Records have loaned the exhibit many interesting early

for **Permanent** resistance
today and tomorrow...

OHMITE
Resistance Units



Many factors contribute to the permanent performance of Ohmite Units—factors of design and construction that enable them to meet every condition of service . . . to withstand shock, vibration, heat and humidity . . . and keep going. These characteristics make Ohmite Rheostats, Resistors, Chokes and Tap Switches especially well fit for today's critical wartime needs.

What's more . . . Ohmite leadership in developing an extensive range of types and sizes has made it possible to serve innumerable applications. All this, of course, makes them readily applicable for the new peacetime products of tomorrow. Ohmite Engineers are glad to assist on any problem for today . . . or tomorrow. Write on company letterhead for helpful Industrial Catalog and Engineering Manual No. 40.

Send for Handy Ohmite Ohm's Law Calculator. Thousands of these Ohmite Calculators are in practical use today. Figures ohms, watts, volts, amperes—quickly, easily. Solves any Ohm's Law problem with one setting of the slide. All values are direct reading. Send only 10c in coin to cover handling and mailing. (Also available in quantities.)



OHMITE MANUFACTURING COMPANY
4984 FLOURNOY STREET, CHICAGO, U. S. A.



Small and Tough

THERMADOR THERMATITE TREATED TRANSFORMERS

Engineered to lick extreme temperature and humidity problems on the firing line, Thermador Transformers are effectively *Thermatite treated*. Thermatite is the time tested process of accurate heat-controlled vacuum impregnation, developed and improved exclusively by Thermador during the last decade.

THERMADOR
Electrical Mfg. Co.
5119 S. Riverside Dr.
Los Angeles, Calif.

"Seven Leagues Ahead"



pieces of recording apparatus. Among them are: the original hand-made model of the Bell and Taintor Graphophone (1885), the production model of the Treadle Graphophone (1886), the first disc model Graphophone (1900), an early wax cylinder phonograph (1898), the first record changer for cylinder records (1900), one of the first electric motors for phonographs (1896), a cylinder duplicating machine (1895), a cylinder record matrix (1902) and several early types of recording horns. Columbia is also lending a display showing their lamination process in making records.

Decca Records has sent the exhibit many early records, including some of the first discs made by Emile Berliner, the inventor of the disc method of recording, and a display of record jackets.

Signal Corps Seeks Used Radio Equipment

Radio amateurs have been requested to sell their short-wave communication equipment to the Signal Corps, Army Services of Supply. This equipment is needed both for training purposes and operational use, the War Department announces.

The radio communication equipment needed consists of transmitters, ranging in power from 25 watts to 450 watts and covering various bands in the short-wave range, as well as the corresponding types of receivers and such radio components as capacitors, resistors, and installation material. Especially desired are audio-frequency and radio-frequency signal generators and oscilloscopes, precision ac and dc voltmeters, ammeters and milliammeters, and other equipment for testing.

Address Philadelphia

Used equipment will be purchased if it is in perfect operating condition or if it can readily be restored to such condition. The price paid for each item will be set by a Signal Corps inspector.

Persons in possession of the desired equipment who wish to sell it for the use of the Army are invited to send a brief description, including name of manufacturer and model type, to Captain James C. Short at the Philadelphia Signal Corps Procurement District, 5000 Wissahickon Avenue, Philadelphia, Pa.

The complete list of the desired equipment follows:

Transmitters—Hallicrafter and Collins.

Receivers—Hallicrafter, National, RME, Hammarlund, and Howard.

Meters—Weston.
Capacitors—Mica and Paper.
Oscilloscopes, Audio Signal Generators and RF Signal Generators.

FCC Divides Radio Spectrum Into 7 Bands

A new classification of radio frequencies, divided into seven major bands, is announced by the FCC to become effective immediately. As a result of the Commission's action, Section 2.5 of the FCC General Rules and Regulations on the "Useful Radio Spectrum" was revised.

Commission spokesmen said that the new rule was devised so that all the United Nations would be "speaking the same language" in referring to classes of radio frequencies. The new classification is to be followed by all military communications staffs of the United Nations. The Interdepartment Radio Advisory Committee has adopted the new classification. This is similar to that drafted by the CCIR in 1937 except that the latter classification was carried in meters rather than kilocycles.

The Section 2.5 of the Rules and Regulations will read as follows:

Section 2.5 Useful radio spectrum. "Useful radio spectrum" means the total number of frequencies or wavelengths which may be used for the transmission of energy, communications or signals by radio.

(At the present development of the art the useful radio spectrum is considered to extend from 10 kilocycles to 3000000 kilocycles or 30000 meters to 0.01 meters. These frequencies are classified into bands with designations and abbreviations as follows:

Frequency in Kilocycles	Designation	Abbreviation
10 to 30 inclusive	Very Low	VLF
30 to 300	Low	LF
300 to 3,000	Medium	MF
3,000 to 30,000	High	HF
30,000 to 300,000	Very High	VHF
300,000 to 3,000,000	Ultra High	UHF
3,000,000 to 30,000,000	Super High	SHF

Electrical Wholesalers War Conference

Because of the importance of the products of the electrical industry in winning the war and also because of the necessity for improving and speeding up distribution methods for getting those essential materials where they are needed most efficiently and speedily, the National Electrical Wholesalers Association will hold an Industry War Conference at the Hotel Statler, Buffalo, N. Y., May 24th to 26th inclusive. The program committee is as follows: W. I. Bickford, Westinghouse Electric Supply Co., Pittsburgh, Pa., Chairman; D. L. Fife, Fife Electric Supply Co., Detroit;

This is a sealed **IGNITRON**



• The sturdy steel-jacketed G-E sealed ignitron for power conversion is available in ratings ranging from 20 amp to 200 amp. It is one of a complete line of electronic tubes which General Electric supplies to manufacturers and users of all kinds of electronic equipment.

It can be used instead of rotating machinery for converting A-C to D-C

Industry uses the G-E sealed ignitron — a steel-jacketed electronic tube — in many ways. One of the most important is as a power rectifier — converting alternating current to direct current.

Practically all power distribution today utilizes alternating current. But *direct current* is essential for many industrial operations — for example, electrolytic processes in aluminum and magnesium plants; and for operating motors that require speed adjustment. Typical D-C motor loads are machine tools, grinding machinery, cranes.

Rectifiers using the G-E sealed ignitron for D-C power at 250 volts or more

generally will have about the same installed cost, but lower operating costs than a motor generator set. Such equipment has no moving parts. It requires no special foundation. It is quiet in operation. Over-all efficiency is high, and practically constant over the entire load range.

The sealed ignitron is only one of many kinds of G-E electronic tubes working for industry.

It is the purpose of the G-E electronic tube engineers to aid *any* manufacturer of electronic devices in the application of tubes. Through its nation-wide distribution system, G. E.

is also prepared to supply *users* of electronic devices with replacement tubes.

If you will send us the names of interested people in your organization, we will keep them informed of electronic tube developments. For example, we would like to mail every one interested a full color spectrum chart showing typical electronic tubes and their applications. Please write on your company letterhead. *Electronics Department, General Electric, Schenectady, N. Y.*

Tune in on Frazier Hunt and the News every Tuesday, Thursday, Saturday evening over C. E. S. On Sunday night listen to General Electric's "Hour of Charm" over N. B. C. See your local newspapers for time of broadcast and station.

GENERAL  **ELECTRIC**

162-B2-8850

PRECISION PARTS

PUTTING SOME
VERY SPECIAL
SCREWS TO HITLER

Like most of the precision work that Ace men and women are now machining and grinding with an accuracy that makes paper seem mattress-thick, this jack-screw has an unmentionable part in war aviation. Let's just say it helps add many miles per hour to fighter planes.



Double lead, close tolerance.

But that needn't keep us from telling you that it is over six inches long and that its thread tolerance is "plus 0, -0.005". And if you study it carefully you'll see that it has a dual lead—two threads parallel with each other.

There's only one way to get accuracy like that into thousands of Acme threads. You have to grind the threads, and if you have to grind them in quantity you'll be wise to send them to Ace. For Ace knows production-grinding, and can perform tricks of Centerless, Thread, and Surface Grinding that are imperative in wartime and will be equally imperative to your post-war product. Our Thread-Grinding department is now at capacity, but for all other metal parts which combine accuracy and volume, have an Ace up your sleeve. We will welcome samples or sketches.

Capacity open except in threads.



ACE
MANUFACTURING
CORPORATION
for Precision Parts

1239 E. ERIE AVENUE, PHILADELPHIA

W. J. Kranzer, Crannell, Nugent & Kranzer, Inc., New York.

Charles G. Pyle is managing director and E. Donald Tolles is treasurer of the NEWA, with headquarters at 400 Fifth Ave., New York.

O. F. Mingay Heads Australian Radio at Wash., D. C.

O. F. Mingay, former managing editor of Australian Radio Publications, of Sydney, Australia, and general secretary of the Institute of Radio Engineers in Australia, is now in Washington with headquarters at the Australian War Supplies Procurement, 1700 Massachusetts Ave., N.W.

For two years Mr. Mingay was in the Australian Army, Signal Corps, until last year when he was appointed for duty with the Directorate of Radio and Signal Supplies of the Ministry of Munitions, wherein he is now manager of the radio division, and responsible for the entire production of all radio communication equipment for all the services under General MacArthur's Command. Due to a critical situation arising out of an extreme shortage of certain raw material and vital tubes, he has come to Washington to explore the situation and see what could be done in the way of radio assistance being afforded General MacArthur's requirements.

**Cathode-Ray Tubes
Added to Preferred List**

Captain J. B. Dow, Bureau of Ships, Navy Department, Washington, D. C., announces additions to the Army-Navy Preferred List of Radio Electron Tubes printed in "Electronic Industries" for November, 1942, page 79.

Added to the list as there presented are four cathode-ray tubes: 2AP1, 3BP1, 5CP1, and 9EP1.

With certain exceptions, it is mandatory that all unclassified tubes to be used in all future designs of new equipments under the jurisdiction of the Signal Corps Laboratories or the Radio & Sound Branch of the Bureau of Ships, be chosen from the complete Preferred List.

**Broadcast Engineers'
Salaries**

The Federal Communications Commission has just completed a salary survey of the earnings, during the week of Oct. 11, 1942, by 22,954 broadcast station employees. Of this number 2,635 were executives averaging \$100.09 weekly. Engineering executives were re-

vealed to be among the lowest paid in this group, receiving weekly salaries of \$66.59, as compared with "general managerial," \$140.32; program, \$66.57; commercial, \$104.77; publicity, \$75.40; and others, \$82.38.

Among the 4,584 technical employees reported on, 105 research and development men averaged \$68.58 per week; 4,184 operating men averaged \$49.23; and 295 other technical employees average \$30.92.

Now Plenty of Steatite

Steatite no longer is a bottleneck in the production of military radio equipment, according to manufacturers who participated in the recent meeting of the Industry Advisory Committee on Ceramic Capacitors and Steatite. The chairman was Elmer Crane, Chief of the Components Section, Radio Division, WPB.

The producers stated that they are able now to accept orders for delivery in from four to eight weeks. In contrast, the backlog last summer was approximately eight months.

Two factors make it possible for the industry to catch up with its accumulation of orders. Facilities constructed to meet war demands are now in operation, and phenol plastics were substituted for steatite in radio apparatus. Because the phenol situation is tightening, it was urged that steatite should be put to greater use.

Producers of ceramic capacitors forecast sharp increases in output within about two months. The gains will reflect the use of new facilities now being completed.

**Dr. Zworykin Explains
Scanning Microscope**

"Applications of the Electron Microscope in Metallurgy" was the title of an address given by Dr. V. K. Zworykin of RCA's Princeton laboratories during the 1943 convention of the Institute of Mining & Metallurgical Engineers at New York. Following a survey of the subject, Dr. Zworykin gave the following description of the scanning electron microscope used for observation of opaque surfaces and sections:

"An electron-optical system resembling an inverted electron microscope forms an extremely fine electron probe which is made to scan the surface to be studied. Whenever incident, this probe liberates secondary electrons; since their number is a function of the



BUY BONDS

electronic PRECISION PARTS

MACHINED FOR ACCURACY



**TUBE PARTS
WIRE FORMS
METAL STAMPINGS
BURNER TIPS
FOR ALL APPLICATIONS**

Additional space and equipment now enables us to serve a larger clientele in the field of Electronic Industries, with precision parts and stampings.

"The *difficult* things we do at once — — — the *impossible* takes a little longer" . . . many problems that seemed impossible were successfully solved by our Engineering staff and special machines were built to do the job. Why not let Haydu Bros. tackle that difficult problem?

HAYDU BROS. products are synonymous with quality and economy, as is evidenced by the constant need to expand our manufacturing facilities.

SPECIALISTS IN BURNER TIPS FOR ALL APPLICATIONS

"The Place of Quality and Economy"

HAYDU Brothers

A MEMBER OF THE RADIO MANUFACTURERS ASSOCIATION

**PRECISION PRODUCTS FOR RADIO, ELECTRICAL,
AVIATION AND INSTRUMENT MANUFACTURERS**

Mt. Bethel Road
PLAINFIELD, N. J.
Telephone:
PLAINfield 6-0878

Tube illustrated is a National Union Product



It's just good sense to treat your microphone with respect, so it will give you longer, better service. A microphone is a delicate, sensitive instrument and needs protection.

For instance, a fall doesn't have to damage the case to damage the mike. The shock may prove destructive to the interior.

Under no circumstances should you open the mike case and expose the sensitive parts to mechanical and chemical damages which ruin the mike. If the seal is broken on a crystal mike, the crystal absorbs moisture and becomes useless.

Read carefully the instructions which come with your mike, and be certain the circuit is correct for the type mike you are using. Don't use power generating or voltage generating microphones (dynamic, ribbon and crystals) in circuits intended for carbon or condenser mikes. Make sure your mike is made for rough weather before exposing it to the elements. If your mike fails or gives trouble, send it to the factory or its dealer.



condition of the surface at the point in question, their number may be regarded as a measure of the "brightness" of the surface at that point. These secondary electrons are accelerated toward a fluorescent screen and generate there a light signal, which is reconverted into an electrical signal by the photocathode of an electron multiplier.

"Enormously amplified by electronic means, this signal actuates the printer bar of a facsimile receiver in unison with the electron probe scanning the specimen and thus prints out a picture of the specimen surface. The time required to record a single micrograph is about eight minutes. The relatively great complexity of the apparatus results, primarily, from the extreme fineness of the electron probe—it must be only some hundred Angstrom Units in diameter—and the corresponding smallness of the signal currents. Only the use of the electron multiplier as a preamplifier and the increase of recording time to several minutes, prevent the random voltage fluctuation occurring in conventional amplifier systems from causing a deterioration of the image.

"Although it is to be expected that the resolving power of the scanning microscope will always remain somewhat lower than that of the standard electron microscope, it may perform valuable services in the study of specific objects."

High-Voltage Supply for Cathode Ray

The accompanying picture shows the 30,000-volt supply for cathode-ray tubes, discussed by O. H. Schade of the cathode-ray tube division, Lancaster Engineering Department of RCA, before the recent IRE con-

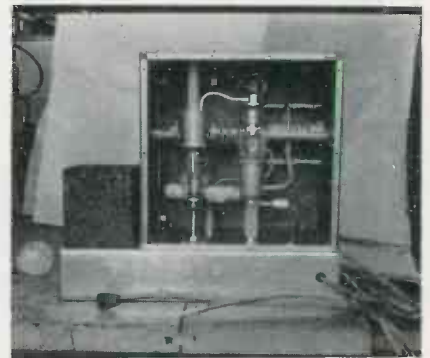

vention at New York. This is a developmental 30-kv voltage-doubling circuit for projection-tube supplies. The large unit is 1 cu. ft. in size and furnishes the second anode voltage for the projection tube. The small enclosed unit on the left side contains the 6-kv focusing voltage supply which is also an rf type.



THIS FREE BOOK TELLS YOU HOW TO CARE FOR YOUR MIKE

Send NOW for your Free Copy of Turner's new 8-page, fully illustrated, colorful Microphone Catalog. Each unit is engineered for specific jobs and trouble-free performance. Select the one best suited to your needs at the price you want to pay.

Free
THIS NEW TURNER
MICROPHONE CATALOG

The
Turner
Company

Cedar Rapids, Iowa

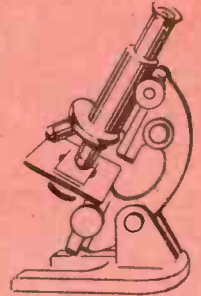
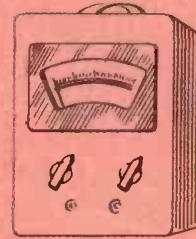
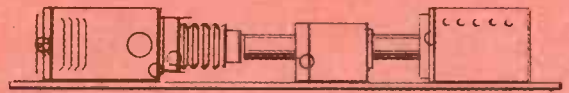
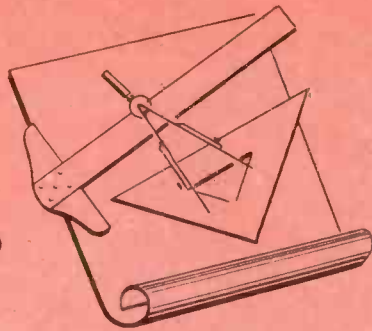
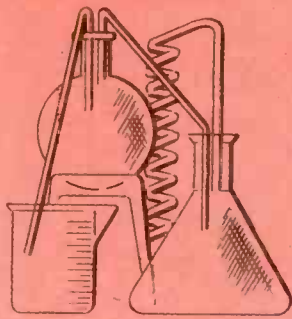

RESEARCH

THE SOURCE AND SENTINEL OF AMERTRAN PERFORMANCE

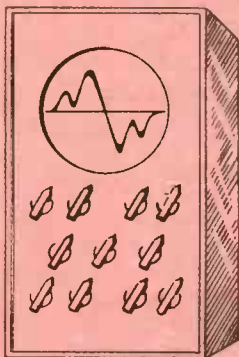

In the design and manufacture of transformers, reactors and rectifiers — for war and industry — Amertran moves steadily forward through research.

Research for major improvements. For refinements. Research to uncover new applications. To develop products for future needs. In a word, to meet engineering requirements of ever-changing, ever-growing complexity.

For example — today's opposing trends that call for smaller and lighter units for one class of service, and larger, heavier units for another.

Continuous research, in the field as well as in the laboratory, helps to keep Amertran out in front in radio and electronic applications. It also supplies the background for an intelligent approach to your problems.

Whether your problem is a finished product, ready for service, or a component for your own assembly, you may have the full benefit of Amertran research through our engineering cooperation.

AMERICAN TRANSFORMER COMPANY, 178 EMMET ST., NEWARK, N. J.

AMERTRAN

MANUFACTURING SINCE 1901 AT NEWARK, N. J.

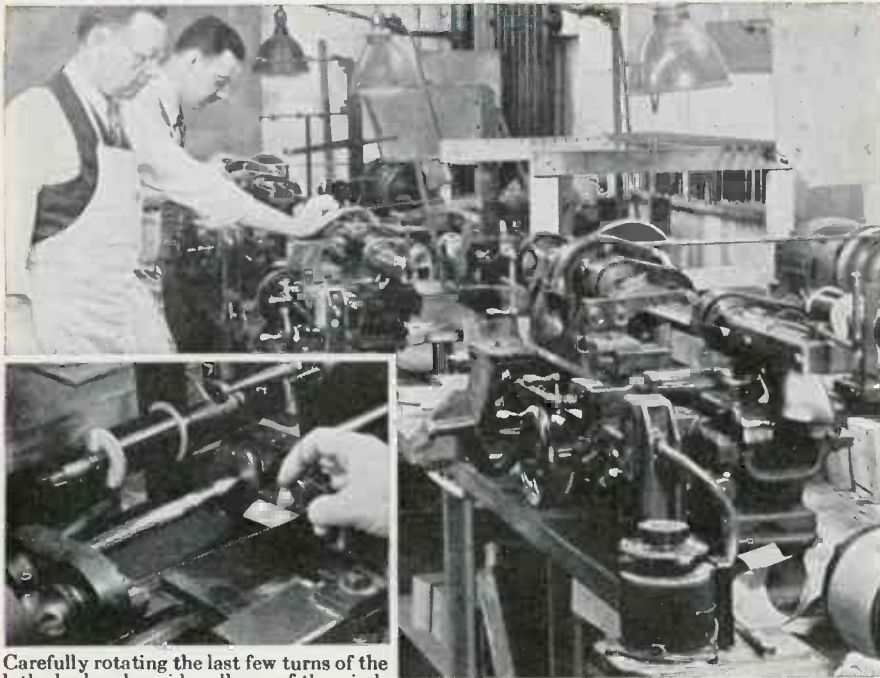

Carefully rotating the last few turns of the lathe by hand avoids collapse of the winding on the steepest slope of cards with a logarithmic taper. These logarithmic units can be used *with* an external series resistor to obtain a truly logarithmic resistance, or *without* the series resistor to give the steepest possible slope to the resistance characteristic.

Although the winding of all resistance cards for General Radio potentiometers is essentially automatic, experienced workmen adapt the winding speed to each particular unit through Variac control of the motor drive.

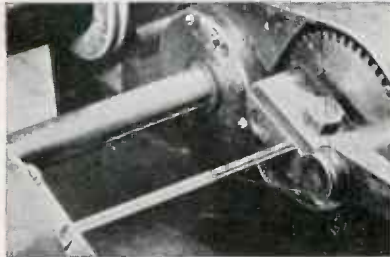

Putting the *second* winding on an Ayrton-Perry, or non-inductive, resistance unit. This unit is used as the output control in a standard-signal generator operating at frequencies up to 50 megacycles.



Spring-mounted pulleys absorb variations in wire tension as the card turns. Constant tension is provided by a spring device on the shaft carrying the spool of wire.

How G. R. Rheostat-Potentiometers are Wound

The resistive elements are wound on flat fabric-base phenolic cards, which are then bent around molded cylindrical forms. To achieve definite resistance characteristics—linear, parabolic, or logarithmic—many sizes and shapes of cards are used. More than one size of wire on a single card necessitates abrupt changes in card width. For non-inductive units, two similar windings in opposite directions on a single card are necessary.

General Radio has developed winding methods and adapted standard lathes to produce all these various windings. Constant-tension devices and automatic feed insure precise control of winding. The finished resistance element has turns accurately spaced and presents a smooth uniform surface to the sliding contact. This results in long life and trouble-free operation.



General Radio instruments use a wide variety of these variable wire-wound resistors as calibrated controls in bridge and other measuring circuits. Originally designed for our own use, these rheostat-potentiometers are essential elements in many electronic instruments and are now widely used by other manufacturers of precise electrical equipment.



“Radio in Air Travel” by G. F. Quinby, RCA

The article on “Radio in Air Travel” appearing on page 84 of the February issue of “Electronic Industries” was prepared by G. F. Quinby of the aviation-radio section of RCA Victor Division, Camden, N. J., who also drew up the radio range diagram. Airplane pictures reproduced were provided through the courtesy of American Airlines.

Machine Tool Forum

A number of electronic applications will be discussed at the Westinghouse “Machine Tool Electrification Forum” April 6-7 at East Pittsburgh, Pa. The session “Electronics at work”, at 2:30 p. m. Tuesday, April 6, will include demonstrations by Dr. P. Thomas, a paper on electronic motor control by T. R. Lawson, and one on machine tool oil mist and smoke removal, by E. H. R. Pegg. A discussion period will follow presentation of the papers.

During the 9:00 a. m. to 1:00 p. m. session on Wednesday, Frank W. Curtis, design engineer of the Van Norman Machine Tool Company, will present a paper titled “Practical Applications of Induction Heating”.

Gen'l Stoner Chief of Operating Services

Brigadier General Frank E. Stoner, who in the past year has directed the growth and operations of the Army Communication Service to its present tremendous size and efficiency, has been appointed to the post of Chief of the Signal Operating Services under the Chief Signal Officer.

The designation of General Stoner to this new position places him on a parity with Major General Roger B. Colton, Chief of the Signal Supply Services. Major General James A. Code Jr., Assistant Chief Signal Officer, had previously been Chief of the Signal Operating Services, handling it with his post of Assistant Chief Signal Officer.

At the same time, Colonel Ira H. Treest, Signal Officer of the Western Defense Command of Lieutenant General De Witt, was ordered to Washington to take over the directorship of the Army Communications Division to succeed General Stoner.

Under General Stoner in his new position as Chief of the Signal Operating Services will be his old Army Communications Division with its Plant, Traffic and Signal Security Branches; the Signal Troops Division, headed by Briga-



GENERAL RADIO COMPANY
Cambridge, Massachusetts

NEW YORK

LOS ANGELES

BETTER AIR INDUCTORS FOR TODAY'S JOBS

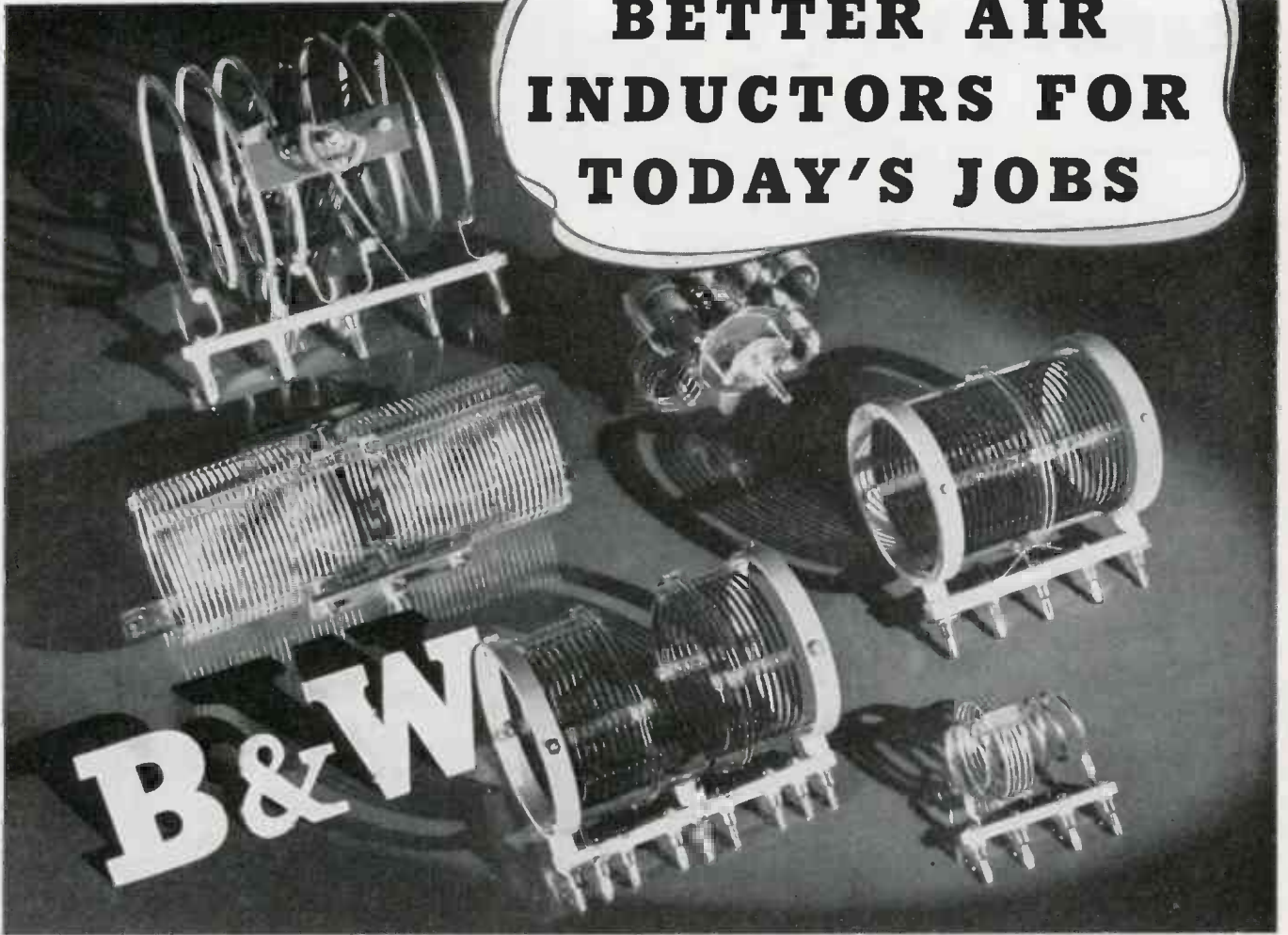

Fast deliveries on standard models and wartime adaptations

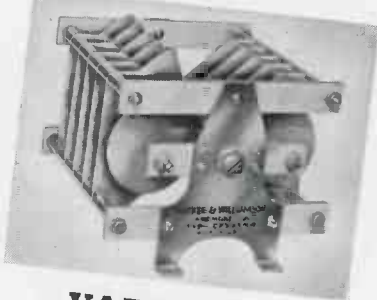

VARIABLE AIR CONDENSERS

Heavy war demands have resulted in ten league strides in the production of B & W Variable Air Condensers, too. These famous Condensers are shorter than conventional units, have built-in neutralizers and coil-mounting feature, and are unexcelled for exacting high-power uses. Technical Data Sheet upon request.

It is a matter of record that most of today's exacting wartime inductor coil applications can be met—fully and completely—by standard B & W units, with perhaps only minor construction changes or adaptations to meet specific conditions.

It is also a matter of record that B & W is now producing Air Inductors by the most modern "line" methods—faster, better, in larger quantities than they have ever been made before.

We'd like to stack these greatly expanded facilities against your next coil order—whether it calls for standard or highly special units—and regardless of any "fixed for fightin'" specifications. B & W delivers the goods—and that not only means promptly, but with rigid maintenance on our highest quality standards!

BARKER & WILLIAMSON

Manufacturers of Quality Electronic Components for 10 years

235 FAIRFIELD AVENUE, UPPER DARBY, PA.

CANNON TYPE "P"



...ideal Connector for Radio and Sound

A connector designed over a decade ago to meet the primary needs of the electronics engineer, it is, today, the recipient of wide acclaim in the fields of radio, sound and television.

It effectively solves the problem of conveying low-level circuits and small power applications, and is dependable under all conditions.

The practical features of the Type P Connector, *the full floating socket and rigid pin insert which serve to eliminate excessive strain on contacts . . .* together with its rugged construction and compactness, make this plug highly desirable wherever there is limited space or need of speedy coupling.

The precision engineering back of the Type P Connector and the features designed to aid the user are typical of every item in the Cannon family of dependable connectors.

The Cannon Catalog Supplement gives data on Type P and seven other types of Connectors. Make request on your business letterhead and we'll send you a copy. Address Department T, Cannon Electric Development Company, Los Angeles, California.



CANNON ELECTRIC

Cannon Electric Development Co., Los Angeles, California
Canadian Factory and Engineering Office: Cannon Electric Co., Ltd., Toronto

REPRESENTATIVES IN PRINCIPAL CITIES—CONSULT YOUR LOCAL TELEPHONE BOOK

dier Frank C. Meade, with its War Plans, Military Personnel and Military Training Branches; and the Army Pictorial Division under Col. E. M. Lawton.

General Stoner started his Army career as a private in the Infantry in 1914 and because he early showed marked ability was selected for the Military Academy, attending West Point from 1916-17 until the United States entrance into World War I when he was commissioned a second lieutenant in the Philippine Scouts. He joined the Signal Corps as a captain in July 1926.

Human Relations in Industry

The efficiency of workers is shown to be more closely linked to morale than any other factor, in a pamphlet, "Workers and Bosses are Human," issued by the Public Affairs Committee, 30 Rockefeller Plaza, New York. Single copies are available at 10c.

"There is definite evidence," according to Thomas R. Carskadon, "that working conditions—how a worker feels about his job and what happens to him on the job—affect not only his health but his output." In scientific experiments at the Hawthorne plant of the Western Electric Company, a group of girls on the assembly bench, who had a real sense of "participating" and "accomplishing," increased their production under all conditions of work. A group of men, on the other hand, who were deliberately kept in the dark about the nature of the experiments, were mistrustful and kept their production level down despite an opportunity to increase their pay under a generous "incentive" system.

DeWalt and Gable Head GE Tube Design

K. C. DeWalt and A. C. Gable have been named designing engineer and administrative assistant, respectively, in the tube division of the General Electric Electronics Department, at Schenectady, N. Y., according to an announcement by O. W. Pike, engineer of the division.

Mr. DeWalt, born in Vinton, Iowa, is a graduate of the University of Iowa where he received his B.S. in E.E. degree in 1927. Upon graduation, he immediately was employed by General Electric and went to work in the Testing Department.

Mr. Gable was born in Macon, Ga. He was graduated from Georgia School of Technology with a B.S. in E.E. in 1929, and was employed by the General Electric Testing Dept. late in that year.



Said the Paratrooper to the Plane:
**"Snipers in woods—
 give 'em a burst!"**

They work together better . . .
 because they can talk together

From a thousand feet up
 The burning airdrome
 Looks like
 A "pushover" . . .

But
 When you get
 Right down to earth
 It turns out to be
 Anything but.

Suddenly the trees
 To the right
 Start throwing lead —
 And your men
 Are still hanging
 Like clay pigeons
 In their harnesses.

* * *

What a break
 That you're equipped

With a
 Two-way
 Radio.

What a break
 That you can tell your trouble
 To a friendly
 Fighter plane.

* * *

Today, communication equipment
 Designed and manufactured
 By I.T.&T. associate companies
 Is helping Uncle Sam's fighting forces
 Work together
 On land, sea and in the air . . .

Tomorrow the broad experience
 Of I.T.&T.
 In the field of communications
 Will help build a better world
 For every man.

INTERNATIONAL TELEPHONE AND TELEGRAPH CORPORATION 67 Broad St., New York, N. Y.

I T & T

Manufacturing Associate:

FEDERAL TELEPHONE AND RADIO CORPORATION

THESE TOUGH LAMPS ARE SPATTERPROOF



a RADIANT achievement to which CALLITE contributed

Greater protection, increased production and less breakage is now made possible by Radiant's new spatterproof lamps. Made of a special glass that resists penetration of hot metal particles, Radiant Spatterproof Lamps fill a long-felt need for a lamp that would last longer and stand up safely under the roughest handling.

Contributing to the long life and reliability of Radiant Spatterproof Lamps are sturdy, jar-proof filaments made of Callite Tungsten wire. Callite wire was chosen for the light-source of

these lamps because of its complete dependability—proven in thousands of electronic applications.

The long experience and painstaking research that has made Callite dependability possible is at your service. Callite Engineers will gladly assist in determining the most efficient solutions to your metallurgical problems.

Specialists in the manufacture of lead-in wires, filaments and grids—formed parts and special materials for all electronic applications.

CALLITE TUNGSTEN CORPORATION

544 39th STREET



UNION CITY, N. J.

CABLE: "CALLITES" • BRANCH OFFICES: CHICAGO • CLEVELAND

Wedemeyer Changes to "Electronic"

In order to better indicate the nature of its business activities, the Wedemeyer Radio Company, 221 E. Liberty St., Ann Arbor, Michigan, has changed the firm name to Wedemeyer Electronic Supply Company.

Dr. Hector to Nat'l Union

Dr. L. Grant Hector has joined the National Union Radio Corporation of Newark, N. J., and Lansdale, Pa., radio and electronic tube manufacturers, as director of engineering, announces S. W. Muldowny, president of the corporation.

Dr. Hector has a broad and varied background of electronic scientific research experience. He is a graduate of Oberlin College and Columbia University, has served as physics instructor at Oberlin, professor of physics at the University of Buffalo, and at the time he joined National Union was engaged in electronic development work for the Office of Scientific Research and Development of the U. S. Government.



Dr. Hector has gained wide recognition through his writings which include articles and books dealing with magnetic, dielectric and acoustical measurements by electronic techniques. Text books by Dr. Hector include Modern Radio Receiving (1927), Introductory Physics (1933) and Electronic Physics now on the press.

Ken Rad Builds Big Plant

The Ken-Rad Tube & Lamp Corp. of Owensboro, Ky., will construct \$1,300,000 plant at Tell City, Ind., to produce equipment for the Signal Corps under a Defense Plant Corp. contract.



To fill a need McElroy Model PFR-443 Wheatstone Code Tape Perforator

Normally, automatic radiotelegraph apparatus is employed by all services, commercial, military or governmental. But despite the present availability of sufficient quantities of this equipment due to McElroy design of simple and rugged units through mass production, communication has been impeded, in many cases, by the lack of simplified, efficient perforating devices. Intricate keyboard perforators, requiring the attention of specialized machinists and skilled operators have restricted quantity production of perforated tape.

Simplified in design, the new PFR-443 will produce tape as cleanly and as accurately as any complex keyboard perforator.

The McElroy Wheatstone Code Tape Perforator is actuated by 110 volt AC or DC current. May be operated with index finger, middle finger and thumb of the right hand, while unit is in similar position as a hand telegraph key. The feather-light touch on the dot and dash contacts and space bar closes electrical contacts. A powerful die mechanism, driven by a solenoid, perforates and advances the tape through the machine. When this tape, identical in all respects to others prepared by the most complex of keyboard perforators, is passed through any make of automatic transmitter now in existence it will execute signals with the precision characteristic of all professional automatic devices, at any speed for which the transmitter was designed.

Simple and rugged in design and construction, the McElroy perforator requires no critical adjustments. Parts are replaceable by any competent radio technician. Light in weight, it may be carried as a hand semi-automatic transmitting key. When teamed with the McElroy Automatic Transmitter, XTR-442, the combination becomes a manually operated radiotelegraph station that is the equal of any mechanized station.

As creative telegraphic engineers, we are leaders in our field. We are the largest manufacturers in the world devoted exclusively to the production of equipment for the transmission and reception of dots and dashes. We create. We design. We build. We do not imitate and we do not copy. And we can deliver.



T. R. McElroy, world's champion telegraphist and outstanding wireless operator of all time, operating a development model of the new perforator in conjunction with Tape Transmitter, Model XTR-442.

Unskilled operators have been trained more readily in the use of this perforator, than the standard keyboard of a typewriter. Any station with newly trained personnel may transmit its traffic with absolute accuracy, retaining the tape as a permanent file record of all communications. The McElroy Wheatstone Code Tape Perforator may be operated in conjunction with automatic transmitting equipment at maximum speeds — or with similar efficiency, at speeds of between 25 and 50 words per minute. It may be employed for *important communications circuits* as readily as for preparation of practice material for radiotelegraph code schools.

The McElroy factory is being tooled for production and orders are being accepted. Moderately priced at \$375. First deliveries may be anticipated by the latter part of May.

McELROY MANUFACTURING CORPORATION
82 BROOKLINE AVENUE BOSTON, MASSACHUSETTS

Freedom FROM BOUNCE

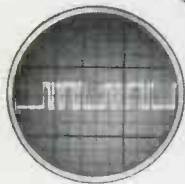
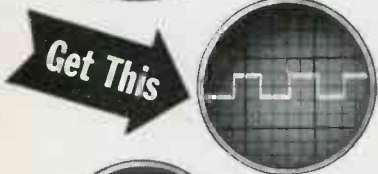

In high-speed switching, you want sharp, positive action that is free from chatter and bounce . . . that's just what you can get with SIGMA Sensitive Relays.

With total operating delay held in the vicinity of one millisecond, SIGMA relays permit up to 200 contacts per second, even in the presence of severe vibration, and at extremes of temperature and pressure.

We cannot state general conditions under which such results can be attained. Submit your problems to us . . . security of all information—military or commercial—is strictly assured.

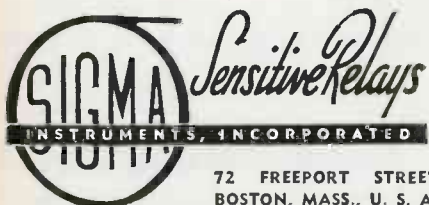

72 FREEPORT STREET
BOSTON, MASS., U. S. A.

Trust Fund

The United Electronics Company, of 42 Spring Street, has instituted a trust fund under which its 250 employees will share in war-work profits, to be paid at the end of the war.

To be eligible, an employee must remain with the company until after the war, unless called to military service. The amount to be paid each employee will vary in proportion to his salary. In event of his death the money will go to his heirs.

Absenteeism at the plant has declined sharply since the plan went into effect. It is proposed to pay out the employees' share over a period of years. However, if an employee leaves, becomes ill or is discharged after the war, a lump payment is made. The fund is invested in government bonds, and each employee is given a "bank-book," or record of his share, which will be revised several times a year.

Solar Gets Army-Navy E

The Solar Manufacturing Corporation, Bayonne, N. J., has been awarded the Army-Navy "E" for its contribution to excellence in the production of war equipment.

This company has been manufacturing capacitors (mica, paper and electrolytic) "Elim-O-Stats" (radio noise suppressors) and capacitor analyzers since 1932, for industrial, radio, television and service applications.

The presentation of the award will be held early in April at which time prominent Army, Navy, state and civil Officials will join with the management and several thousand employees in appropriate ceremonies.

Tung-Sol Chief



R. E. Carlson, vice-president of Tung-Sol, Newark, N. J., has just announced appointment of G. A. Bodem to be sales manager for radio tubes, lamps, and special products. W. B. Masland, who heads market research and advertising, is now on loan to WPB, Washington

Radio Engineeress!

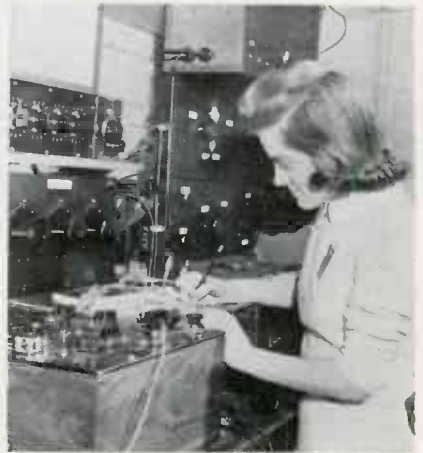

This is 21-year old Margaret Allen, first woman to work in General Electric's radio-receiver engineering section at Bridgeport, Conn. Miss Allen is one of the special training graduates now replacing men in giving skilled assistance to engineers in laboratories and factories. She was graduated from William and Mary College with a B.S. in chemistry and physics.

Directory Additions

In the Electronic Engineering Directory in the March, 1943, issue of "Electronic Industries," we regret that the following companies were omitted from the proper classifications.

Batteries, Dry & Wet

Philco Radio & Television Corp., Tioga & C Sts., Philadelphia, Pa.

Inter-Communicating Systems

Talk-A-Phone Mfg. Co., 1219 W. Van Buren St., Chicago, Ill.

Webster Electric Co., 1900 Clark St., Racine, Wis.

Recording Equipment & Blanks

Jensen Industries, 737 N. Michigan Ave., Chicago, Ill.

—Cutting needles

Tubes & Parts

Freeland & Olschner, Inc., 611 Barrone St., New Orleans, La.

Ken-Rad Tube & Lamp Corp., Owensboro, Ky.

Garner Co. Opens New Chicago Plant

Fred E. Garner Company of Chicago announces the opening of Plant No. 2 at 1100 West Washington Street, Chicago. This new plant will be devoted to manufacturing frequency meters, test equipment, radio telephones, direction finders, silent and sound-picture projectors, and other radionic devices.

The company will occupy three entire floors. The factory will be equipped with the latest production devices and a complete installation of Convers-O-Call intercommunicating units. An unusual type of flexible production line has been devised for this new factory which

NORTH AMERICAN PHILIPS COMPANY

Electronic Research and Development



PRODUCERS for Victory—of Tungsten and Molybdenum in powder, rod, wire and sheet form; Tungsten Alloys; Fine Wire of all drawable metals: bare, plated and enameled; Diamond Dies; Electronic Test Equipment; Cathode Ray Tubes; Amplifier Tubes, Rectifier Tubes; Transmitting Tubes; Oscillator Plates.

X-Ray Apparatus for industrial, research and medical applications. (Philips Metalix Corp.)

NORTH AMERICAN PHILIPS COMPANY, INC.

Factories in Dobbs Ferry, N. Y., Mount Vernon, N. Y. (Philips Metalix Corp.) Lewiston, Me. (Elmet Division).



In step with the electronic science of today and tomorrow are the resources skills researches developments and products of Ken-Rad

There is no art of industry or war in which electron tubes cannot be used to accomplish heretofore impossible tasks These impossibles will bring an early Victory followed by peaceful applications of electronic devices to which Ken-Rad will make available its experience and a complete line of dependable electronic tubes

TRANSMITTING TUBES
CATHODE RAY TUBES
SPECIAL PURPOSE TUBES
METAL AND UHF TUBES

KEN-RAD

OWENSBORO KENTUCKY U S A

makes possible faster production of various types of precision equipment.

The engineering staff will be located at the new plant at 1100 West Washington Street,— the general offices will remain at 43 E. Ohio Street, Chicago.

Laird Ohmite VP



Roy S. Laird, sales manager, Ohmite Manufacturing Company, Chicago, has been named vice-president of the company. Laird will continue in charge of sales. Ohmite today is producing rheostats, resistors, chokes, tap switches, and attenuators for war equipment and for industry

Signal Corps Calls for Transmitters

Radio amateurs have been asked by the Signal Corps to sell transmitters ranging from 25 to 400 watts in power for military field sets, together with their receivers. Showing the need for components the Army has also sought the purchase of capacitors, resistors, audio frequency and radio frequency signal generators, oscilloscopes, precision ac and dc voltmeters, milliammeters, and all installation material specially needed. A party of Signal Corps officers is now touring the country to conduct the purchases.

Fred M. Link Awarded "E"

The award of the Army-Navy "E" to Fred M. Link and Link Radio Company, 125 West 17th Street, New York City, was signalized March 24 with ceremonies and a dinner at the Hotel New Yorker, attended by the Link organization and many well-known radio men, old friends of Mr. Link. Frederick T. Budelman, vice-president and chief engineer, acted as master of ceremonies. Major William S. Marks of the Signal Corps made the presentation, which was accepted by President Link.

High Altitude

OIL-FILLED CAPACITORS

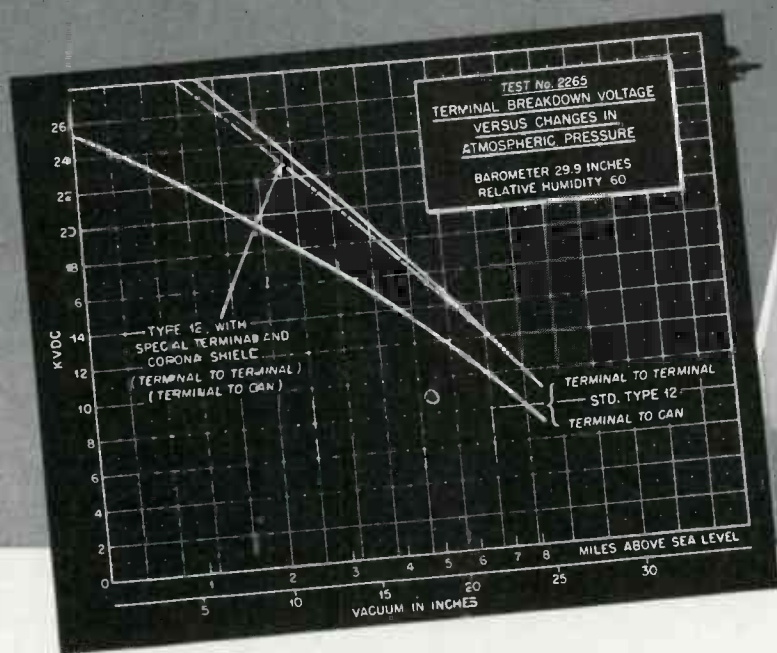

Photo Courtesy of Bell Aircraft Corp., makers of the famous Airacobras.

• Type 12 is a standard Aerovox capacitor. Exclusive Hyvol dielectric oil. Special ceramic insulators on ribbed cap, for ratings up to 7500 v. D.C.W.

At high altitudes encountered in aircraft applications, however, things do happen. While Hyvol maintains the effective capacitance even at sub-zero temperatures found high above the earth, the terminal breakdown voltage drops rapidly in the rarefied atmospheres.

To meet such conditions, Aerovox engineers redesigned the terminals of Type 12. One terminal became

a short screw post. The other, a tall ceramic insulator with corona shield at top. Result: minimized surface leakage; minimized corona losses; greatly stepped-up breakdown voltage at high altitudes. The chart tells the story.

Ingenious revisions and adaptations of standard Aerovox types, such as this, are meeting unusual requirements—quickly, fully, economically.

Write for latest Transmitting Capacitor Catalog. And try A.A.E.* on that tough capacitance problem.

*Aerovox Application Engineering



Capacitors

INDIVIDUALLY TESTED

AEROVOX CORPORATION, NEW BEDFORD, MASS., U. S. A. • SALES OFFICES IN ALL PRINCIPAL CITIES
Export: 100 VARICK ST., N. Y. C. • Cable: 'ARLAB' • In Canada: AEROVOX CANADA LTD., HAMILTON, ONT.

Designed for



Application



THE 37222 POSTS AND 37202 PLATES

Such details as: (1) the square shoulder on the mounting stud of the post which seats in the slot in the plate so as to prevent annoying loosening of the posts when operating the clamping head; (2) the telescoping boss and socket so as to permit the plates to grip tightly the thinnest chassis as well as the thickest panels without necessity of grinding or filing; (3) the availability of the plates in Steatite, Mica filled natural bakelite, as well as standard black phenolic; are but three of the "Designed for Application" features that make this terminal set more desirable to use than others.

**JAMES MILLEN
MFG. CO., INC.**

MAIN OFFICE AND FACTORY
**MALDEN
MASSACHUSETTS**



NEW BOOKS

Guide to Cathode-Ray Patterns

By Merwyn Bly, Associate Engineer, Navy Dept. Published by John Wiley & Sons, New York. 39 8½" x 11" pages, spiral bound. Price \$1.50.

This manual provides a laboratory manual and test bench reference for typical cathode-ray oscillograms that are most frequently found in common experimental projects. The reproductions delineated all have well defined captions which describe the conditions under which they were produced.

Therefore the book provides an easily understood laboratory guide for students, service men and others in getting acquainted with a cathode-ray oscillograph. The book also gives complete information as to how to analyze the various patterns. Most of the text concerns frequency comparisons, waveform studies, modulation patterns, square wave testing, resonance curves and vacuum tube characteristics. Over 175 patterns are shown, with additional spaces for sketches and problems for the student.

What You Should Know About the Signal Corps

By Harry M. Davis and F. G. Fassett, Jr., published by W. W. Norton & Co., New York, 1943. Price \$2.50.

The importance of the Army Signal Corps and the progress of military communications "from torch to electronic tube," are graphically described in this book. Mr. Davis, formerly scientific writer on the New York Times, is now employed in the office of the Chief Signal Officer. Professor Fassett, is a member of the faculty of the Massachusetts Institute of Technology and editor of the "Technology Review."

The latest methods of communications, employed by the armed forces, which have been developed by the Signal Corps through the cooperation of the communications and radio industries, are related in non-technical but accurate language by the two authors. Mr. Davis, an electrical engineer, who has been portraying through magazine articles for the Signal Corps many of the highly interesting developments of that service, is particularly well qualified for the exposition of the Corps to the public. One of the most interesting chapters in the book is the final one which touches on the communications and electronic developments which will flow out of the discoveries and inventions produced in

the war procurement effort. Television in color will be right around the corner when peace comes; the electron has remarkable potentialities for communication and many other uses in industry and daily life, including the electron microscope and even the telescope.

The scope of the book is illustrated by the titles of its 10 chapters—"The Signal Corps in Modern War"; "From Torch to Electronic Tube"; "The Signal Corps in War and Peace"; "The Signal Corps in the Services of Supply"; "The Army Communications Service"; "Getting the Message Through"; "Men of the Signal Corps"; "Army Photography"; "Materiel of Signal Communication"; and "Signals and the Future Citizen".

Radio Data Charts

Compiled by R. T. Beatty, republished by Electronic Laboratories, Inc. Indianapolis, Ind. with permission of Wireless World, London. Second edition.

This notebook presents a series of commonly used nomographic charts covering thirty radio design problems. The charts are well drawn and their use is explained without complications. The pages are bound along the top edge so that they lie flat to assist in the use of straight-edge scales which is a part of their operation. The 8½ in. x 11 in. pages are spiral bound, with heavy leatherette-covered board covers.

The charts seem to have been prepared with full knowledge of the problems encountered by an engineer, and in most cases answers can be derived with a minimum of effort. In all formulas where a single factor appears more than once, the charts follow the forms where the directive line between the scales must lie tangent to a special function curve. This form of chart is more difficult to prepare but provides greatest simplicity in use.

A Course in Radio Fundamentals

By George Grammer, published by The American Radio Relay League, West Hartford, Conn., 1942, 104 pages, 50c.

The book contains assignments, experiments and examination questions based on the Radio Amateur's Handbook. It is primarily intended to teach the individual home student and it takes into account the fact that just reading a book is not enough to acquire familiarity with a subject. The fundamentals of radio certainly will be well known to anyone who conscientiously follows the assigned text.

AS QUICK AS SHE CAN SAY JACK ROBINSON...



There's a break in the power line . . . and Jack Robinson is lost in the acres of machinery.

Yet he's found in a flash—thanks to Straight-Line Communication.

It's a shotgun that can't miss . . . it reaches individuals, groups, or the entire plant quickly, clearly.

But the amazing thing is that many modern plants still rely on time-wasting indirect methods of communication—despite the fact that paging by Straight-Line Communication does it better and quicker than by any other means. It more than pays for itself in a short period of time.

If your factory or plant has any communications problems whatever . . .

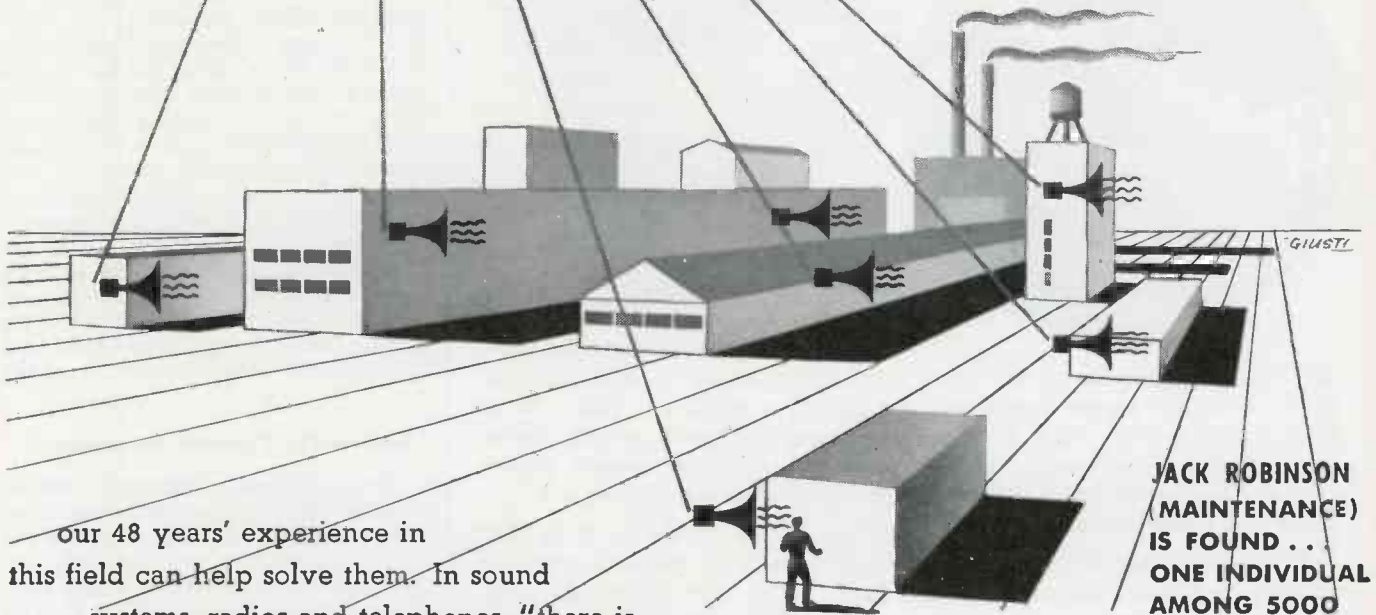

our 48 years' experience in this field can help solve them. In sound systems, radios and telephones, "there is nothing finer than a Stromberg-Carlson." Why not get in touch with the Sound Systems Division of the Stromberg-Carlson Telephone Manufacturing Company, 100 Carlson Road, Rochester, New York.

**JACK ROBINSON
(MAINTENANCE)
IS FOUND . . .
ONE INDIVIDUAL
AMONG 5000**

STROMBERG-CARLSON



STRAIGHT-LINE COMMUNICATION SAVES MANPOWER • SPEEDS THE WORK TO VICTORY

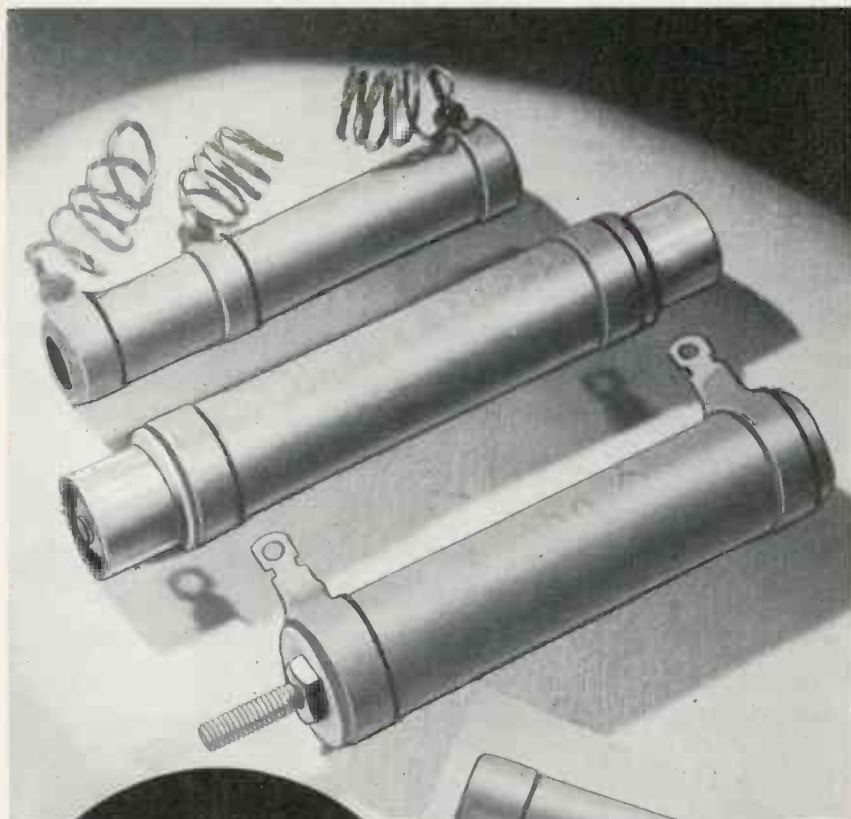

Greenohms
either STANDARD
or SPECIAL

★ Those green-colored (for identification) power resistors found more and more in severe-service electronic, radio and electrical assemblies these days are **Greenohms**.

They are **extra-rugged**, as proven by impartial tests and the service records out in the field. The extra safety factor is due to the exclusive inorganic cement coating in

which the resistance winding is imbedded and protected. This coating provides improved radiation of heat for cooler operation. Also, this coating will not crack, flake or peel despite severe overloads and heat shock.

Standard types in 5 to 200 watt sizes as fixed resistors, and 10 to 200 watt sizes as adjustable resistors. Special types in widest range of terminals, mountings, taps, sliders, etc.

★ For that assembly in which you seek extra safety factor, consider **GREENOHMS**. They cost no more. Remember, only **Clarostat** makes **GREENOHMS**. Let us quote on your high-priority requirements. Literature on request.

CLAROSTAT

Controls and Resistors

CLAROSTAT MFG. CO., Inc. - 285-7 N. 6th St., Brooklyn, N. Y.

NEW LITERATURE

Automatic Ballast-Regulating Tube

Amperite is an automatic rheostat designed to keep the current in a circuit at a definite value. It is an iron wire hermetically sealed in a bulb containing hydrogen and helium. Its regulating action is based on the high temperature coefficient of resistance of the iron wire and the rapid cooling of the gases which flattens or extends the regulating characteristics. Four-page bulletin describing the tube available from Amperite Co., 561 Broadway, New York.

Industrial Equipment

"Electronic Index of Industrial Equipment" is the title of a pamphlet issued by Electron Equipment Corp., Palm Springs, Calif. The company's rectifiers and electronic controls are illustrated and described.

Type U Test Set

Of special interest to communication engineers is a newly-revised catalog which describes the well-known Type U Test Set. This sturdy, portable Wheatstone bridge is designed especially for communication purposes in measuring resistance and capacitance. It is best adapted for locating faults on telephone and telegraph cables, for identifying faulty wires in a cable, for measuring conductor resistance, for locating grounds and crosses by Murray, Varley and Hilborn loop tests, and for locating opens by capacitance tests. Leeds & Northrup Company, 4934 Stenton Ave., Philadelphia, Pa.

Automatic Control Equipment

Zenith Electric Company, 152 W. Walton St., Chicago, manufacturer of automatic control equipment has just published a new bulletin on: magnetic contactors, reversing controls, automatic reset timers, process timers, program clocks, remote control switches, automatic transfer switches, etc. The bulletin gives details of construction, latest improvements, applications and prices.

Magmotor Memo

Magmotor Memo is a new house organ published by Carter Motor Co., 1608 Milwaukee Ave., Chicago, which will contain information on dynamotors, converters and other rotary equipment for engineers or Government Training Schools. Service "kinks," articles, round table discussions will also be included.

Styraloy 22

A new synthetic elastomer for electrical and mechanical applications requiring low temperature flexibility and high temperature stability called Styraloy 22 is announced by The Dow Chemical Co., Midland, Michigan. A 16-page booklet describing the plastics mechanical and physical properties is available.

Colloidal Graphite

Acheson Colloids Corp., Port Huron, Mich., has just published a new 12-page illustrated bulletin, No. 430-DD, on the importance of "dag" colloidal graphite to modern industry. This bulletin describes the physical and chemical properties of "dag" colloidal graphite and how it differs from other forms of graphite, especially in regard to particle size; the reasons for liquid carriers and how dispersions are accurately controlled.

Price List

Insulation Manufacturers Corp., 565 W. Washington Boulevard, Chicago, issued a price list of adhesive tapes made by Industrial Tape Corp. These tapes are called "pressure sensitive" to distinguish them from products that have to be heated or moistened to obtain their adhesive qualities. They are made by applying special types of adhesive masses to one side of a suitable backing material with the result that instant adhesion to a surface can be obtained by finger pressure only.

Allied Releases 1943

Buying Guide

Allied Radio Corporation, 833 W. Jackson Blvd., Chicago, announces the publication of a new 1943 Buying Guide covering "everything in Radio and Electronics." Special emphasis is placed on industrial, research and production requirements, as well as the needs of the armed forces and government agencies for radio and electronic supplies. Included are complete detailed listings of transformers, resistors, condensers, rheostats, relays, switches, rectifiers, electronic tubes, tools, wire and cable, batteries, sockets, generators, power supplies, converters and all other types of equipment in this field.

E-Z-Code Labels

A four page bulletin on coding electrical wires and conduits has been released by Western Lithograph Co., 600 E. Second St., Los Angeles, Calif. The labels are protected with a special transparent coating for permanence.

THE **FASTEST** Method of BLACK AND WHITE RECORDING . . .



This Alden recorder was specially designed to produce facsimiles up to 8" width.

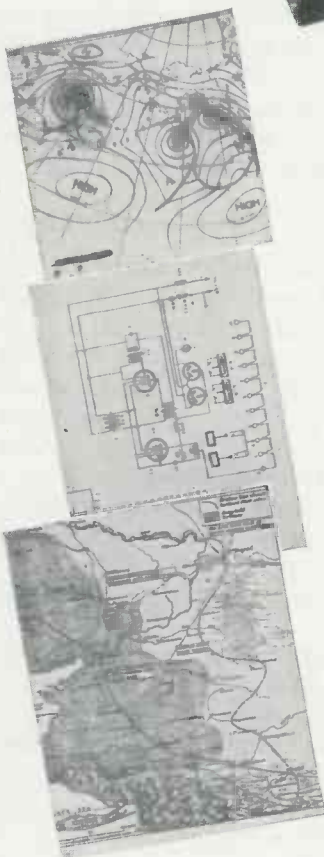

Anything convertible to an electrical impulse may be reproduced by Alden recorders such as these examples shown above.

ALDEN

FACSIMILE RECORDERS

THESE COMPLETE terminal recording units reproduce typed matter, charts, maps, pictures, fingerprints, writing or text of any sort. Speeds of 48 square inches or more per minute are within the recording capabilities of the paper and equipment. Reproduction is crisp and clean and operation of the machine is simple and trouble-free.

Alden facsimile recorders are designed in conjunction with Faximile, Inc., engineers, and built by Alden Products Company. They are based on the *John V. L. Hogan* system, that is proving highly successful on transcontinental and international press circuits.

Alden recording units are custom-built to meet your requirements of speed, width of recording, size and operation with other equipment, or to meet the characteristics of any wire or radio circuit.

For further information, write for booklet B "The Last Word on Facsimile and Electrolytic Recording". No obligation of course.

ALDEN PRODUCTS CO. INC.

117 NORTH MAIN ST.  BROCKTON, MASS.

Licensees under patents and patent applications of Faximile, Inc.

★

Will the End of the War ... mean the end of your job?

★

Train Now for Lasting Success in RADIO and INDUSTRIAL ELECTRONICS

Have you been doing any after-the-war thinking? Have you realized the sudden changes that will take place as war production revolves to civilian production... and millions of men come back to jobs from the Armed Forces?

For many radiomen the end of the war will mean the end of a job. But for those with vision and foresight, the future offers golden opportunities. These men realize that the responsible engineering jobs will go to those who have acquired the technical ability to keep pace with the rapid strides being made in the field of radio and electronics.

Now is the time to make sure of the road ahead. CREI home study courses in Practical Radio Engineering provide a planned program of spare-time specialized training to give you the technical skill to supplement your present ability. Don't say you're "too busy." CREI courses are designed to be studied in the most crowded schedules.

Join the 8,000 professional radiomen now training with CREI. Make your present job pay you dividends by investing a small portion of your earnings in this career training. Get all the important facts at once.

If you have had professional radio experience and want to make more money—let us prove to you we have something you need to qualify for a better job. To help us intelligently answer your inquiry
PLEASE STATE BRIEFLY YOUR BACKGROUND OF EXPERIENCE, EDUCATION & PRESENT POSITION.

• Write for
FREE BOOKLET



FACTORY SHORT CUTS

(Continued from page 61)

DeNike's latest classified ad is headed "CONFIDENTIAL Correspondence." In the form of a soldier's letter to his wife or sweetheart, it reads: "Sally, my dearest: It's chilly tonight in this cave. Our patrol ploughed through knee-deep mud all day, and drying out isn't too easy. It's worth every bit of the discomfort, though, Sal, for I know we're making safe that big, cheery fireplace where we used to sit and dream on bitter cold nights. We nearly got ours today when a patrol of Jerries laid for us. If it hadn't been for Charlie's walkie-talkie our right-flank patrol could never have tipped us off in time. My dear, I think of it as actually being you who saved us. After all, you are making the tubes for the radio that Charlie carried. Good night, sweet, and thank all the other girls at National Union who are backing us up. Love, Bill.

And now the "hook"

"Confidentially, girls just like you, 18 to 45 years old, are making the radio tubes which are saving our boys, winning our battles. We want you to help. We'll pay you well and the work is easy. Won't you come in and see us any day from 8 A. M. to 5 P. M. or Saturday 9 A. M. to 3 P. M.? Come to National Union Radio Corporation, 48 Spring Street, Newark, N. J. Now, please! Do not apply if engaged in war work."

The "Fox Hole Joe" ad reproduced above pulled approximately three times as many applications as the best "old line" classified help-wanted type of advertising.

Hoarders by Accident

Conference between Army and Navy representatives and officials of an electric manufacturing company studied causes for delays in production.

It was agreed that a fundamental factor was difficulty in securing sufficient supplies of raw material for machining, electrical parts, subassemblies.

As means of effectively meeting situation, it was decided to establish Purchase Follow-up Section to place on all orders for material re-

GIRLS

"THEY CALL ME FOX HOLE JOE"

WAR STORY FOR WOMEN ONLY

"Seems hard to believe that only last year I was working in Newark. I've seen so much hell on earth the past few weeks, sleeping in muck up to my ears, dodging bullets, parrying cold steel bayonets, picking myself up after shell explosions. Boy, oh boy, for the peace and quiet of a day back at my job in the factory. I'm not complaining, mind you. I'm in here to kill all the devils I can, so Sis and Mom and all you girls will never have them get near you. Only one thing puzzles me a little. I've heard from home that war plants begging girls to come to work can't seem to get all they need, even when they'll pay well while they train 'em. Can that be possible?"

How about it, girls? Can it be possible you keep thinking that some day you might try war work but just don't get around to it? Well, here's your chance to get in now. If you're 18 to 45 years old, come into our NEW YORK CITY temporary Employment Office at 233 WEST 42ND STREET, SUITE 404, MANHATTAN, on Thursday and Friday only, Feb. 25th and 26th, 8:30 A. M. to 4 P. M. only. We'll teach you to make radio tubes our boys need so badly on every battlefield...and we'll pay you well while learning. If inconvenient to apply in Manhattan on the above days, please come see us any day from 8 A. M. to 5 P. M., Saturday 9 A. M. to 3 P. M., at 48 Spring St., Newark, N. J. Do not apply if now engaged in a war industry.

National Union Radio Corporation.

This want ad in N. Y. Times proved three times as effective as routine copy

required delivery dates projected over period of 6 months. A general survey of all outstanding orders was made, to be tied in with Process Department schedule of production to superimpose new system on more than 100 million dollars worth of existing work then in the plant.

Survey disclosed inventories of certain items as too large, causing slow-downs elsewhere, while others were hampering local production through shortages. ANEPA through its regional office, concentrated on equalizing these inventories so flow of material through plant was evenly balanced.

Effect of this "levelling" of materials was quickly evidenced by increase in production of equipment.

Organization of department and initial survey were completed within 60 days. Much has already been done to eliminate kinks in production and shortages of mate-

CAPITOL RADIO ENGINEERING INSTITUTE

Home Study Courses in Practical Radio
Engineering for Professional Self-Improvement
Dept. EI-4 3224—16th Street, N. W.
WASHINGTON, D. C.

Contractors to the U.S. Signal Corps—U.S. Coast Guard
Producers of Well-trained Technical Radiomen for Industry



When only D. C. power is available, ELECTRONIC DEVICES requiring from 110 to 3250 volt-amperes A. C., can be operated by a rugged Janette rotary converter. Many thousands of such essential safety and other electronic devices, used on ships and shore stations, depend upon Janette converters for power.

Wherever there are ships, you will find Janette converters.

Janette

Janette Manufacturing Co. · 556-558 W. Monroe St. · Chicago, Ill.

2 BOOKS EVERY "WAR-TORN" ENGINEER NEEDS!



\$750
160 Pgs.
(9½x12 in.)

A-C CALCULATION CHARTS

By R. LORENZEN

This new Rider Book greatly reduces the time required for alternating current engineering calculations—speeds up the design of apparatus and the progress of engineering students. Two to five times as fast as using a slide rule! Thousands of enthusiastic users.

A-C CALCULATION CHARTS are designed for use by civilian engineers and engineers of the armed forces who operate in the electrical—communication—power—radio—vacuum tube—telephone—and in general, the electronic field. Invaluable for instructors as well as students, and also executives who check engineering calculations.

CATHODE RAY TUBE AT WORK

The Cathode Ray Tube at Work is the accepted authority on the subject. The cathode ray tube in the Oscillograph and its application to electronic and industrial work is fully discussed. Profusely illustrated. 338 pages \$3.00

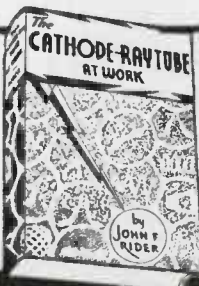

JOHN F. RIDER PUBLISHER, Inc.
404 FOURTH AVENUE, NEW YORK CITY
Export Division: Rocke-International Elec. Corp., 100 Varick St., N. Y. C. Cable: ARLAB



LIKE A THIEF IN THE NIGHT!...

The Time YOU LOSE on Slow Deliveries of RADIO & ELECTRONIC Supplies

DON'T let slow deliveries of radio and electronic supplies rob you of precious time on vital war work. Now, no matter where you may be located, you can save days and weeks in getting the parts or equipment needed. Whether it's one or a hundred items . . . made by many different manufacturers . . . you have only *one* order to write, *one* dependable source to look to for speedy, efficient service. ★ We three cooperating distributors, strategically located, have established a special coast-to-coast war emergency service that delivers the goods faster than you ever thought possible under present conditions. Unusually large, diversified stocks; picked technical staffs; special handling of orders . . . *every facility* has been provided to eliminate delay and to help you maintain working schedules.

Telephone, wire, or mail us your orders.

See what we mean by EMERGENCY SERVICE!



Free

Purchasing Agents and others responsible for specifying or buying may ask for this big reference book and buyer's guide on company stationery. It's packed from cover to cover with information on thousands of radio and electronic products. Send for your copy today. Keep it handy . . . always. You'll find this valuable volume an indispensable technical and buying aid. It's offered FREE to all industrial users of radio and electronic parts and equipment.

WRITE OR PHONE YOUR NEAREST DISTRIBUTOR

TERMINAL RADIO CORPORATION

85 Cortlandt St.
Telephone: WOrth 2-4416

NEW YORK

WALKER-JIMIESON, INC.

311 South Western Ave.
Telephone: Canal 2525

CHICAGO

RADIO SPECIALTIES COMPANY

20th & Figueroa Streets
Telephone: Prospect 7271

LOS ANGELES

One of 10 BURKE

TERMINAL BLOCKS...

BURKE bakelite Terminal Blocks moulded under enormous pressure in hardened steel moulds—10 styles for 2 to 12 wires. Designed to go into Dispatching and Traffic Signal Systems, Switchboard, Fire and Patrol Signal Systems, etc. Impervious to moisture—high electrical resistance—fast to install and economical.

Write Dept. C.T.B. for folder and prices.

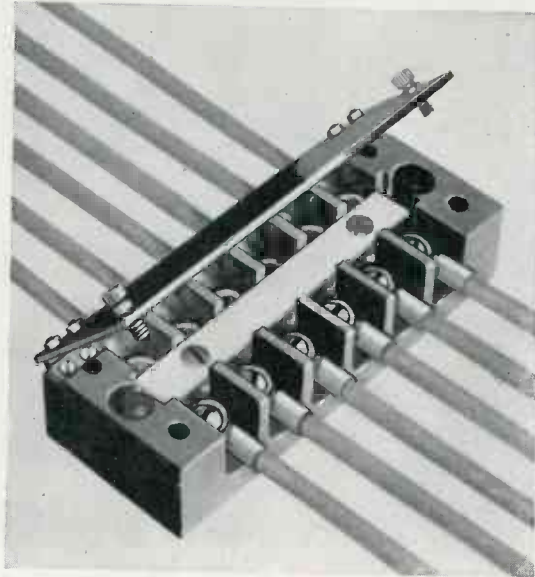

HINGED COVER TERMINAL BLOCK

AC AND DC MOTORS AND GENERATORS
BURKE Terminal BLOCKS
 BURKE ELECTRIC COMPANY • ERIE, PENNSYLVANIA

In the Air... Products
PINCOR
Keep 'Em Winning!

DYNAMOTORS • CONVERTERS • GENERATORS • D.C. MOTORS • POWER PLANTS • GEN-E-MOTORS
PIONEER GEN-E-MOTOR
 CHICAGO, ILLINOIS
 EXPORT ADDRESS: 25 WARREN STREET, N. Y., N. Y.
 CABLE: SIMONTRICE, NEW YORK

rials. Amount of back-ordered equipment has been reduced by 84 per cent and average delivery interval for materials received has been cut 21 days.

ANEPA

(Continued from page 51)

ternational Aid Group, consulting with and lending its expediting aid and assistance to the Allies, and helping them on their Lend-Lease contract requirements.

At the same time, the Production Analysis Control Branch is responsible for the functioning of policies and systems under which materiel is apportioned. One of the important services of this Branch is illustrated in its work on the mica situation. A certain type of radio meter used in both airborne and ground equipment called for the installation of mica capacitors with monthly production schedules on one contract calling for a total of 12,400 mica capacitors in meters per month. Close study of the problem by the Production Analysis Group of ANEPA revealed that paper and ceramic capacitors could be substituted in place of mica without altering cost or efficiency of the operating set. As a result over a hundred thousand critical mica capacitors were conserved on this one contract alone.

SHRINKAGE IN RESISTOR MANUFACTURING

(Continued from page 63)

yield, data in the charts of composition resistors will show the following yields at "Stores":

Tolerance	Size	12/1 to 12/5	12/6 to 12/12
20%	¼	81	88
"	½	90	95
"	1	96	86
"	2	88	91
10%	¼	52	63
"	½	69	74
"	1	83	84
"	2	68	75
5%	¼	39	—
"	½	39	43
"	1	48	49
"	2	34	44

From these data for the 20 per cent tolerance, which all resistor manufacturers are able—or should be able—to meet, it seems evident

that average yields are no higher than 90 per cent in dry weather. This would indicate that the losses due to shortcomings in the production process are likely to be about 9 per cent under favorable weather conditions. For 10 per cent tolerances the average yields are no higher than 70 per cent and for 5 per cent average yields are no higher than 42 per cent. But under 20 per cent tolerance conditions in dry weather the average yields were as low as 81 per cent. It is believed that, with the general improvement which could be expected in humid weather of at least 15 per cent, the humidity control (dependent on how well the job is done) will improve yields 15 to 30 per cent. In the fixed-composition field this will likely mean a saving of from \$600,000 to \$1,200,000 in 1943. This estimate is believed conservative. A relative humidity of 40 per cent is considered adequate.

One more point should be added. It is of the utmost importance, if any effort is made to safeguard fixed composition resistors from moisture in the air during production, that the resistors be protected against regain when finished. From information obtained from the Bell Laboratories and from materials and chemical engineers, it is evident that certain waxes have proved to be highly resistant to moisture flow and that these waxes have been used by the Bell Laboratories and the Western Electric Company for impervious coatings against moisture.

These waxes are:

Superla No. 8 (MP 163° F.)

Biwax No. 745 (MP 180° F.)

Zophar Mills Co. No. 1340 (MP 180° F.)

Zophar Mills Co. No. 1592 (MP 182° F.)

If cellulose acetate is used in the resistor, these waxes would have melting points that are too high for safety.

In view of the situation which faces the resistor industry it is apparent that an extreme bottleneck will be reached in from 4 to 6 months. Also in four months the humid period, in which losses are heaviest, will be with us. On the basis of this evidence, it is felt that no fixed composition resistor man-



WE CAN HANDLE SUBCONTRACTS THAT REQUIRE:

- Radio, Electronic or Mechanical Engineering
- Completely Equipped Tool Room
- Automatic Screw Machines
- Hand Screw Machines
- Swaging Operations
- Punch Presses
- Drill Presses
- Threading Operations
- Lathe Operations
- Milling Operations
- Foot Presses
- Wire Braiding
- Light Section Spot Welding
- Intricate Soft and Silver Soldering
- Buffing and Sanding
- Careful Inspection
- Parkerizing
- Plating
- Painting or Spraying
- Infra-red Baking or Air Dried Finishing
- Intricate Mechanical and Electronic Assemblies



We offer the facilities of our two modern plants to any manufacturer faced with production problems. Our equipment is particularly well adapted to turning out intricate mechanical or electronic assemblies, and we would prefer work involving our assembly department. However, we can accept contracts for any one or more of our production units, except that we are not interested in work which involves only our screw machines.

Our two plants comprise 72,000 square feet of floor space, and we have several hundred trained employees on our payroll. Expert engineering and development services are available. Our company is well financed and now engaged in prime and subcontracts for war production, but is able to take on considerably more.

Address all inquiries to The Ward Products Corporation, 1523 East 45th Street, Cleveland, Ohio.



The **WARD PRODUCTS CORP.**
CLEVELAND, OHIO

production report:

PULLEYS, THUMBSCREWS, produced in PLASTICS (without molds) for your WAR INSTRUMENTS



THIS PULLEY, produced by Creative of laminated plastics, **WITHOUT MOLDS**, is used on a precision balance. Grooved, set-screw hole tapped 3-56.



SET SCREW with threaded I. D. Upper portion of O. D. scalloped for finger grip, polished finish. Produced by Creative **WITHOUT MOLDS**.

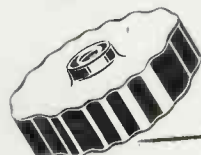

SCALLOPED THUMB SCREW, another example of Creative's mold-free production; I. D. features left-hand thread.



PRECISION PULLEY, by Creative in laminated Bakelite, without molds. Three friction-free turning points; note inside-under-cut.

Illustrated Folder Showing Many Other Items Sent on Request

CREATIVE PLASTICS CORP.

963-969 KENT AVE.
BROOKLYN, N. Y.

STABILIZED A. C. VOLTAGE UP TO 25 KVA

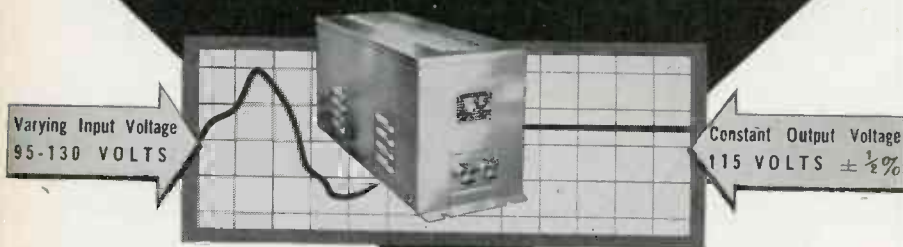

INSTANTANEOUS ACTION

NO MOVING PARTS

When a precision electrical device or a critical process is powered from an AC line, a Raytheon Voltage Stabilizer will permanently eliminate all of the detrimental effects caused by AC line voltage fluctuations. Made for all commercial voltages and frequencies, single or three phase.

Raytheon's twelve years of experience in successfully applying the Stabilizer to hundreds of perplexing voltage fluctuation problems is at your service. It will pay you to take advantage of our engineering skill.

Write for Bulletin DL-48-71 JE describing Raytheon Stabilizers.

RAYTHEON MANUFACTURING CO.

100 Willow Street

WALTHAM, Massachusetts

manufacturer can afford to overlook the opportunity to improve yields by installing controlled humidity equipment at once.

CHEMICAL INDUSTRIES

(Continued from page 55)

sistance of a liquid or gas to the passage of a current of electrons, inherent radioactivity, or behavior in an electrostatic field. Meters, recorders, and controllers of various types to measure pH and for use in titration work are in almost universal use.

A very few elements possess natural radioactivity. Potassium is one, and its emission of radiant energy may be made use of as a direct indication of the quantity of potassium present in a given compound. An apparatus developed by American Cyanamid employs a Geiger counter tube and associated amplifying equipment for this purpose. The Geiger counter tube is a gas-filled, two element tube in which a discharge is "triggered" by reception of a given quantity of radiation from an external source. The source in this case is a glass cell, surrounding the tube, filled with approximately 20 cc of the solution being analyzed. Since the determination of potassium in the presence of other alkalis and certain anions is a lengthy, difficult process, the speed, simplicity, and automatic nature of the radioactivity measurement method lends itself to wider use in certain chemical industries.

A relatively new tube, the hollow-diode, may have unsuspected applications in the chemical field. Developed for a specific purpose, it detects and measures minute traces of water vapor in pure hydrogen supplied to a heat-treating chamber used in connection with precision steel parts. Hydrogen atmosphere is used to prevent oxidation. The glass envelope of the tube is provided with an inlet and an outlet. The hydrogen passing through does not interfere greatly with passage of electrons from the hot filament to the plate of the tube unless water-oxygen atoms is present. The plate circuit current changes can be calibrated to correspond with known percentages of water vapor in the hydrogen. The device

could be adapted to certain other combinations of gas and contaminant.

Another method of analysis in quite general use makes use of the fact that electrolytic conductivity may, with other variables known, provide a measure of some chemical property of a test-solution. One such conductivity meter, manufactured by Cenco, makes use of a 1,000 cycle tube oscillator to supply source voltage to a Wheatstone bridge arrangement with the electrolyte as the unknown quantity. An electron ray, or "magic eye" tube, is used as a null indicator and the instrument is calibrated directly in ohms. For routine process-line use, some other calibration might be employed.

Electrostatic separation

The process of separating finely mixed materials according to their behavior in a high-voltage electrostatic field now depends on high-vacuum rectifiers as a source of dc. Improvements in electrostatic separation have resulted in its constantly wide use in numerous branches of the industry. Particles to be separated are fed to a rotating roll-type electrode. In one type of equipment, a small needle-spoked wheel oppositely charged and suitably located with respect to the roll sets up a constant corona discharge. Particles fed to the roll are charged by direct ion bombardment, and adhere to the roll. As the rotation carries them out of the ion bombardment zone, the good conductors fly off, having discharged themselves against the roll; this equalization of potential is aided by a third electrode which consists simply of a neon tube in series with the high voltage to the discharge electrode, and located close to the roll about ninety degrees further around. Non-conducting particles still adhering to the roll as it completes one revolution are wiped off mechanically. As an aid to better separation, the unit is equipped with one or more exactly similar rolls to provide two or three-stage operation.

Electrostatic precipitation

Two processes for precipitation of particles of solid matter from air, smoke, or fumes, are rather



PERMOFLUX ACOUSTICAL PRODUCTS ... On Battlefronts Everywhere!

Victory depends on perfect communications—co-ordinated split-second co-operation between all participating units. Permoflux Acoustical Devices are aiding every Fighting American—carrying through important messages at peak strength and audibility—bringing in vital signals that might otherwise go unheard.

*Why not let Permoflux Engineers assist
with your reproducer problems?*

TRADE MARK
PERMOFLUX

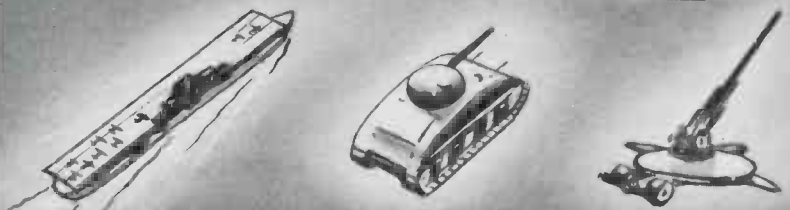

PERMOFLUX CORPORATION

4916-22 W. Grand Ave., Chicago, Ill.

PIONEER MANUFACTURERS OF PERMANENT MAGNET DYNAMIC RECEIVERS

REMLER

Plugs and Connectors

**ARMY
SIGNAL CORPS
SPECIFICATIONS**

Quantity Prices Quoted
on receipt of Delivery
Schedules

*Manufacturers of Communication Equipment
SINCE 1918*

REMLER COMPANY, Ltd. • 2101 Bryant St. • San Francisco, Calif.

widely applied in metallurgical and chemical process plants. In the Cottrell process, direct current of fifty to one hundred thousand volts, supplied by high-vacuum rectifiers, is applied to two conducting plates placed in the path of smoke or fumes to be treated. In addition to reducing fumes exhausted from chimneys, the process is frequently applied to recovery of waste products, often of considerable value.

The principle of the Westinghouse Precipitron is similar. Two large diameter vertical electrodes at ground potential have a fine-wire electrode between and parallel to them. The wire is charged to 12,000 volts positive. All air from which it is desired to remove dust and other particles must pass through this element, then through a "condenser" of interleaved positive and negative plates at about 5,000 volts. Most of the particles adhere fast to these plates until the unit is flushed and the accumulation washed down the built-in drain.

Other applications

Many other electronic devices are at work in various branches of the chemical industries. In automatically fired furnaces, two types of safeguards against explosion are used, sometimes together. An electrode positioned to contact the flame from the pilot and main burner is in the grid circuit of an amplifier. The electrical conductivity of the flame itself is employed as a control, and if be extinguished for any reason, the vacuum-tube control acts instantly to stop the flow of fuel. A phototube trained on the flame may be employed in the same manner.

Photoelectric pyrometers are in wide use, many with more or less elaborate controlling functions. Photoelectric scales automatically weigh out raw materials in many types of plants. Certain applications of electronic relays, sensitive to minute changes of temperature, pressure, movement, etc., are widely used. In the field of remote control of dangerous processes, liquid-level and other indicators employing electronic principles are in use. The use of ultrasonic excitation—vibration at frequencies from twenty to five hundred thousand



Serving ELECTRONIC LABORATORIES

—THE BEAT FREQUENCY
GENERATOR



TYPE 140-A

An unusually versatile laboratory signal generator

Frequency 20 cycle — 5 megacycles
Output voltage range . . . 1 millivolt—32 volts
Output power 1 watt into external load

FREQUENCY MODULATED SIGNAL GENERATOR
QX CHECKER
Φ - METERS

Catalogue B upon request

BOONTON RADIO CORPORATION
BOONTON, NEW JERSEY

cycles per second—to speed various types of chemical reactions has been successfully demonstrated in the laboratory.

While a few familiar electronic devices have been known for many years in the chemical industries, it is interesting to note that a very considerable number of concerns report adoption of other electronic methods as a direct result of the wartime pressure of production. Several new applications, in production or under development, come under the Army-Navy heading of restricted or confidential information. It is clear, however, that the chemical industries can look forward to ever greater utilization of electronic devices and methods, as they continue to demonstrate their superiority.

MILITARY VEHICLES PROGRAM

(Continued from page 58)

quency receivers to determine rf interference radiation. The receivers are carefully calibrated at frequent intervals with a standard signal generator and vacuum-tube voltmeter. Many special precautions are taken with the design and construction of military vehicles to reduce rf noise to a minimum.

Electronic production methods

A number of fairly well-known electronic devices play a part in actual production of vehicles and their power plants. Several types of dynamic balancing equipment are widely used. One machine is almost entirely automatic. A crankshaft is slung in floating bearings and rotated by a belt drive at or near its center. "Wobble" or displacement at the ends due to dynamic unbalance actuates delicate magnetic pickups whose output is amplified to excite circuits which determine the amount and angular location of unbalance. An automatic drilling mechanism then operates to remove the required amount of weight from the proper place.

Radiation pyrometers are used in various ways in the production of engine and chassis components. Typical is the automatic forging heater made by American Car and Foundry Company, shown in use de-



UNIFORM ACCURACY VITAL IN TRANSFORMERS, TOO

Accuracy is more than a matter of design and construction—transformer accuracy and dependability of performance can only be assured when experience, specialized design engineering, modern manufacturing facilities, trained and skilled employees are combined in one organization.

From the earliest days of radio and communication systems, Jefferson Electric has specialized on transformers—working in the field, anticipating the requirements and new developments. Jefferson complete testing, experimental and engineering research laboratories leave nothing to chance. Modern manufacturing facilities with 250,000 square feet of space, and skilled craftsmen insure the uniform accuracy and dependability of performance that users associate with Jefferson Electric Transformers.

Jefferson Electric Line Includes Transformers for:

Radio Receivers, Televisors, Amplifiers;—Communication Systems; Power Circuits; Luminous Tube and Cold Cathode Lighting; Mercury and Fluorescent Lamps; Ignition; Signal Systems; Control Circuits.

The specialized experience of Jefferson Electric engineers can be put to work for you—to save your time and insure the correct selection of the transformers you need. JEFFERSON ELECTRIC COMPANY, Bellwood (Suburb of Chicago), Illinois. Canadian Factory: 60-64 Osler Ave., W. Toronto, Ont.

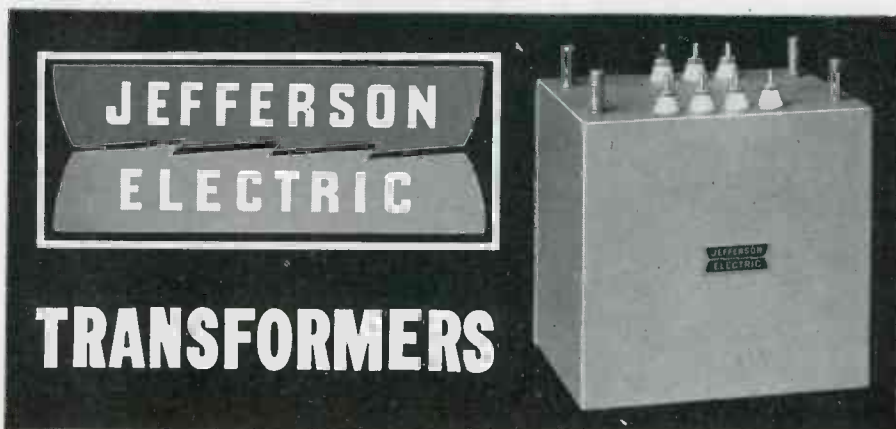

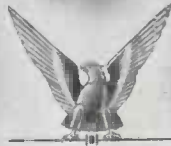

RUGGED



Bliley Crystals

livering heated stock ready for up-setting to form drag-link sockets. Valve stems, treadles, rivets, and many other parts are heated by low-voltage resistance heating with photo-electric control, in dozens of automotive factories. Under all ordinary conditions, a simple dc amplifier operating a relay in response to phototube excitation is stable enough for forging and similar heat-treating operations.

Induction heating, for many hardening and brazing operations, is enjoying greater use by manufacturers of many small engine and body parts. Other applications of electronics to the military vehicle program include wide application of thyratron motor-control, routine and spot-check radiographing of critical castings for engines and chassis, and tube-controlled welding in the fabrication of sheet-metal structures.

THE TELEPHONE STEPPING SWITCH

(Continued from page 79)

the wipers to make contacts in that group. Where more than 50 selections or counts must be made this two-motion switch has the advantage that any one of 100 contacts can be made within 2 seconds, since the switch steps at the rate of 10 steps per second and 20 steps are the most that need be made.

The various switches can also be provided with from 1 to 6 wipers (the maximum varying with the individual type). Thus more than one simultaneous electrically independent circuit can be closed at any step. This is a factor that is often quite important. In applying these switches, the maximum number of wipers available on any particular type will govern its adaptability to a given job.

Local circuits

In cases where local control circuits are necessary the number of wipers must be considered. For example, if you do not wish to use all points on a switch as was the case in Fig. 5, then one wiper must be used to provide for automatic skipping of the points not used. Also, if automatic homing is required with the 25- and 50-point

Solve Voltage Variation PROBLEMS IN AIRCRAFT, TANKS, ETC.

WITH

AMPERITE BATTERY CURRENT & VOLTAGE REGULATORS

Features:—

1. Amperites cut battery voltage fluctuation from approx. 50% to 2%.
2. Hermetically sealed — not affected by altitude, ambient temperature, or humidity.
3. Compact, light, and inexpensive.

Now used by U. S. Army, Navy, and Air Corps.

Send us your problem.

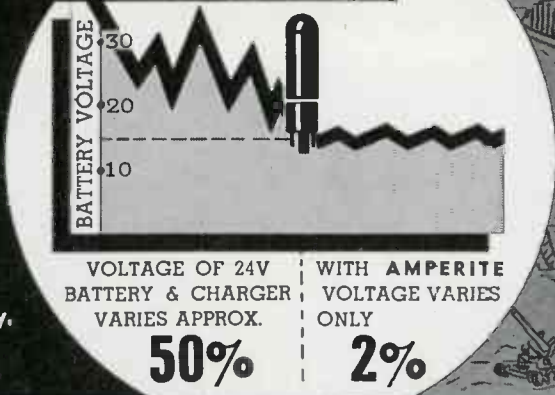

AMPERITE COMPANY • 561 Broadway, New York, N. Y.
In Canada: Atlas Radio Corp., Ltd., 560 King St. W., Toronto

Cable: Alkem, New York

switches, as in Fig. 2, a separate bank level and wiper must be used. The maximum capacity of the switch then available for external control circuits is reduced accordingly.

Switch action

Switches vary in another way. One type of switch has direct stepping action while another has indirect. In a direct type, the switch steps as the magnet is energized. In indirect stepping, energization of the magnet stores energy in a spring, which, when released by de-energization of the magnet, steps the wiper. While in most instances it will not be particularly important whether action is direct or indirect, it must definitely be considered. For example, when counting by the use of 11-, 25-, or 50-point switches, all of which are indirect stepping, the count will not actually be registered until after the initiating contacts open. In other words, the switch moves after the count rather than during the count.

Release methods

Switches vary also in their method of release. The 10- and 100-point switches have separate release magnets which, when energized, permit the switch to restore to normal through the same path over which it operated. The 11-, 25-, and 50-point switches, however, return to home position by advancing in a forward direction to complete the cycle.

In the use of all switches, impulse ratio must be considered. Since the stepping coils have definite operate and release speeds, there is not only a maximum speed at which the switch may be operated, but a minimum length of impulse needed to fully energize the coil and thus insure that the switch will step. The time between impulses must also be sufficiently long to insure that the magnet is fully released, thus allowing the pawl to engage the next ratchet tooth. The ratio between the closed circuit and open circuit time is commonly referred to as the impulse ratio, and is a function of the initiating device.

In the accompanying table (Fig. 8), are given the ideal impulse ratios

★ AIRCRAFT PRODUCTS Co.

ENGINEERS, DESIGNERS
and
MANUFACTURERS
to
THE AIRCRAFT INDUSTRY

... — An organization pledged by experience to serve the needs of communications in the aircraft industry . . . not as manufacturers of the complete units, but as specialists in the production of major components and accessories to make complete installations in accordance with Army and Navy specifications.

SERVING THE NEEDS OF THE ARMED FORCES 100%

★ AIRCRAFT PRODUCTS Co.

OFFICE AND FACTORY: 3504 EAST PONTIAC STREET
FORT WAYNE, INDIANA

WINCO DYNAMOTORS

Are On The Job To Get Them OVER THE SPOT



BERLIN

ROME

Winco Dynamotors are always ready to "dish it out" . . . whether in the numbing cold of the stratosphere or in the flaming desert heat. Right on the job—constant and reliable—they supply power that will keep your communications clear and intelligible.

Simple or complex, whatever your specifications, we believe Winco will meet them. Already our engineers have done marvels in lightening weight, increasing efficiency and eliminating hash. They are at your service for new or special designs. Simply write or wire us. No obligation, of course.

ONLY WINCO GIVES YOU

ALTI-TEMP

The Dynamotor specially designed to insure maximum efficiency at all operating altitudes and temperatures.

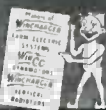

WINCO DYNAMOTORS
WINCHARGER CORPORATION - SIOUX CITY, IOWA

required for the individual switches at 10 impulses per second and 48 volts d.c. The operate and release times of the magnets can be calculated from the minimum and maximum impulse lengths on which the switch will operate. Thus, the ideal impulse ratio for any other speed can be obtained.

Impulse ratios

For example, let's say you want to find the ideal impulse ratio for the minor switch when it operates at 20 impulses per second with 48 volts d.c. applied potential. From the table, you will note that, at 10 impulses per second, the switch must have a minimum per cent make of 16% (operate time of the coil), and will not operate beyond a 90% make (release time is 10%). Knowing that the combined open and closed period of an impulse at 10 impulses per second is .10 second, we determine that the operate time of the coil is .16 second and the release time is .010 second. The sum of these two subtracted from .05 second (the combined open and closed time at 20 impulses per second) gives us .024 second which is the theoretical excess time available at 20 impulses per second. For maximum reliability then, you will add one-half of this time, or .012 second, to the operate time of the switch, and thus obtain a closed circuit impulse time of .028 second. The ideal impulse ratio then, in terms of per cent make at 20 impulses per second, will be this time (.028) divided by the total time (.05 second) or 56%.

If the initiating device you propose to use with a switch does not provide the required impulse ratio and cannot be adapted to do so, some correction is necessary. This can be provided by use of a relay placed in the circuit between the initiating device and the switch. If the impulse length is to be stretched or made longer, the relay release time must be greater than the operate time by an interval equivalent to the amount of stretching necessary. Conversely, if the impulse length is to be shortened, the operate time of the relay must be longer than the release time by the required amount.

The table in Fig. 8 gives other performance data for the various types of stepping switches. The maximum theoretical impulse speeds are obtained on the basis of the sum of the operate and release speeds of the magnets at ideal operating voltage conditions. Naturally, these speeds cannot be obtained in actual applications, not only because of voltage variations normally encountered, but also because of the inability to provide the exact ideal impulse ratio and because of the probability of slight variations in the operate and release times between various switches and on any given switch as the parts wear.

Self-interrupting speed

It will be noted that the average self-interrupting speed is considerably higher than the maximum theoretical impulse speed. This is true because when the switch generates its own impulse, the magnet is energized or de-energized at a specific point during the armature movement and this actually takes place before the armature completes its movement. Thus, a start in building up the coil current and flux may be made before the previous motion has ceased, inasmuch as that preceding motion will be complete before the flux reaches a value to reverse the motion for the next time. Thus, time is saved by preparing for a succeeding step before the preceding one is completed. This of course is possible only where impulse generation is mechanically linked to armature movement.

Switch life

You will note that expected life for each switch is given. The life of any switch will depend a good deal on the care with which it is maintained and the environmental conditions under which it operates. Maintenance care is not complex. On the contrary, it is quite simple. All that is usually required is that the switch be lubricated properly, especially during the early or "wear-in" stages. All switches are, of course, well lubricated as they leave the factory. The 25-point rotary switch need be lubricated only at the end of 50,000, 100,000, and 250,000 half-revolutions, and each half million half-revolutions thereafter,

WESTERN ELECTRIC CO.

"The Arsenal of Communications"

Offers Positions For:

ELECTRICAL ENGINEERS

Or those with equivalent training or experience,
for high-frequency radio work

MANUFACTURING PLANNING ENGINEERS

Men capable of writing operation sheets for assembly and wiring
of high-frequency radio equipment

FACTORY PLANNING ENGINEERS

Men capable of making layouts of machinery and equipment
needed for the assembly and wiring of parts and apparatus used
in communication work

THOSE PRESENTLY ENGAGED IN WAR WORK
WILL NOT BE CONSIDERED

Write (or apply) stating experience and education to:
C. A. J., DEPT. 811

WESTERN ELECTRIC CO.

100 Central Ave

Kearny N. J.



Some of Our "Secret" Weapons Will Be Available For Your Post-War Products

Naturally, many recent electronic improvements are military secrets. But there is nothing secret about the fact that many of today's war-time applications will revolutionize tomorrow's peace-time products. New Conceptions of tolerances, hardly dreamed of in pre-war products, provide unusually accurate, crystal-selected pick ups instantly. Your business future may depend upon the designing or re-designing such improvements into your post-war models. Although our present output goes into war-essential channels, our thinking is not subject to priority. Our application engineers will be happy to make recommendations involving the use of war-perfected crystal units for "future" products.



Gentleman Products Division of HENNEY MOTOR COMPANY

Home Office - FREEPORT, ILLINOIS

Production Office and Factory - OMAHA, NEBRASKA

CRYSTALS BY HIPOWER

Thousands of vital transmitting installations rely on the accuracy and dependability of Hipower Precision Crystal units. With recently enlarged facilities, Hipower is maintaining greatly increased production for all important services. When essential demand begins to return to normal, Hipower will be glad to help with your crystal needs.

HIPOWER CRYSTAL COMPANY

Sales Division - 205 W. Wacker Drive, Chicago
Factory - 2035 Charleston St., Chicago, Illinois

Give your
Recording Troubles
the

"Brush-Off"



"Brush-Off" will positively keep all cuttings away from the recording needle, thereby eliminating skips on the record being made. Fits all automatic and manual recorders. Will save its cost in spoiled records many times over.

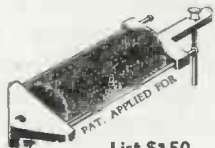

List \$150

In addition to manufacturing, we act as Manufacturers' Agents and Distributors, featuring playback and cutting needles, albums, record racks, cases, blanks and all necessary items.

Our New Location

RECORDIT CO.

315 North 7th St. St. Louis, Mo.
Compton Bldg.

DO YOU NEED the "Impossible" in Deliveries

OF PILOT LIGHT ASSEMBLIES?

DIALCO WILL
HELP YOU
"DELIVER
THE GOODS"
ON TIME!

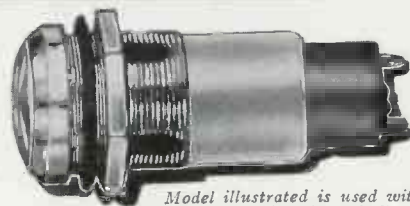

Model illustrated is used with
Neon T-4½ ¼-Watt bulbs.

"Beat the Promise" with Dialco!
Leaders in this field, we are geared to give the service needed to fill urgent war-orders . . .
Send us your problem now, attention Dept. EI

WHAT ARE YOUR DELIVERY SCHEDULES?
LET US HELP YOU MEET THEM.



SEND SPECIFICATIONS, SAMPLES AND BLUEPRINTS WILL BE SUBMITTED PROMPTLY.

DIAL LIGHT CO. of America INC.

90 WEST STREET • NEW YORK, N. Y.



THE ERWOOD COMPANY

WITHIN our book of experience are contained the results of over twenty years in the electronics field.

Today we are engaged entirely in the war . . . tomorrow we hope to devote that experience to the handling of your difficult electronics needs.

223 W. ERIE ST., CHICAGO

**WE TOO, FIGHT
... FOR PEACE!**



Lafayette is doing its part to win the war...and the peace that must surely follow. We play the important part of speeding the war effort by supplying emergency requirements of radio, sound and electronic parts to all branches of the armed forces as well as to manufacturers and sub-contractors. Lafayette is in there fighting to save you time by supplying all of your needs in one order—*quickly!*

Now it is no longer necessary to comb the field to find the various parts you need. Due to Lafayette's extensive buying facilities and large, diversified stocks, one order (no matter how large or how small) will bring quick deliveries on *all* of your requirements.

Free catalog—Radio, Sound
and Electronic Parts—Dept. 4J3

**LAFAYETTE
RADIO CORP.**
901 W. JACKSON BLVD., CHICAGO, ILL.
285 PEACHTREE ST., ATLANTA, GEORGIA

"Quick Deliveries on Radio, Sound and Electronic Parts"

or once each six months, whichever occurs first.

It is also very important that magnet spark protection be employed. This generally consists of a condenser and series resistor connected across the magnet coil, and not only improves switch operation but minimizes the wear on the initiating device's contacts.

In the foregoing, we have provided only a slight indication of the many applications to which stepping switches can be put. Many others are actually in use, and new ones are being conceived every day.

SUPER-REGENERATION

(Continued from page 67)

of the regenerative circuit invention was being fought out in the courts. To prepare a convincing demonstration for the court, Major Armstrong had set up measuring apparatus in his laboratory. A regenerative circuit was part of the set-up. The circuit was arranged to receive a signal from a miniature sending unit across the laboratory without aerial or ground wires. Major Armstrong fiddled with the dials to set the "rig" in action.

"Suddenly other signals of a most unusual character came in," the inventor told the A. I. E. E. "My first thought was that a British cruiser was near by in the North River, since the tone of the signal was somewhat akin to their double-tone spark note and the strength so remarkable. Then it was observed from the character of the messages that the signals were from the Brooklyn Navy Yard. Other well-known stations also came in with a strength hundreds of times greater than any regenerative circuit would give.

New principle born

"As it gradually dawned upon me that some new principle of amplification was being observed, the nature of which I couldn't even guess, the effect disappeared and could not be reproduced—only the feeble response of a simple regenerative circuit was left. Nothing I did would make it behave in other than a quite conventional manner. Five minutes before I would have sworn to the high heavens that I understood all there was to know about regeneration. Five minutes only

were required to wipe out that complacent belief engendered by nearly a decade's work."

"Some completely bewildered experimentation" restored the effect, until it could finally be maintained long enough for examination. Then he went to work to "discover the principle." More work brought to light a principle quite beyond the bounds of his wildest dream, "the existence of which had never been suspected and therefore quite unlikely to have come from purely analytical means."

Then came one of the most astounding and candid admissions ever heard from an inventor. Major Armstrong told the members that not until about 1935—fifteen years afterward, and twenty years after the first publication of his "regenerative" paper did he realize, while looking over the old paper, that a real super-regenerative circuit as well had been included, but that the principle had been missed.

"The original apparatus, then still intact, was set up," he recalled, "and 'super-regenerated' beautifully. It is seldom that one avoids the penalty for a blunder such as this."

The famous superheterodyne circuit was invented in exactly the opposite way. The theory was completely evolved first and the apparatus afterward.

NEW STANDARDS FOR INSTRUMENTS

(Continued from page 81)

cause of the tremendous amount of redesign necessary, this has not been made mandatory.

Non-conforming types

Obviously the manufacture of panel-type instruments which do not conform to this standard cannot be immediately discontinued. Existing designs under which equipment is being and will continue to be fabricated are such as not to permit complete substitution with standard instruments. At the same time instruments are not in many cases interchangeable and cannot be used for direct replacement of existing meters which may fail in service.

However, it is understood that the Armed Forces and the instrument

Ever See a Picture of a SHORT CIRCUIT?

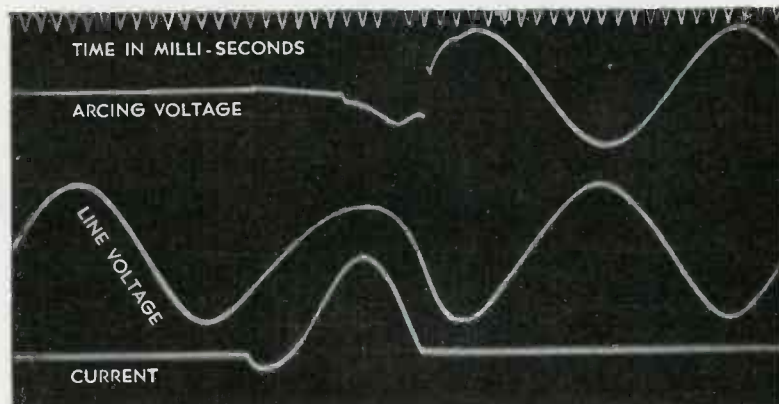

Oscillogram taken on a 50 ampere breaker showing short circuit with 6450 amperes rms flowing through the breaker which interrupted within 1/2 cycle on 120V AC with a power factor of approximately 60%. This was the third operation on a circuit having a capacity of approximately 8000 amperes rms.

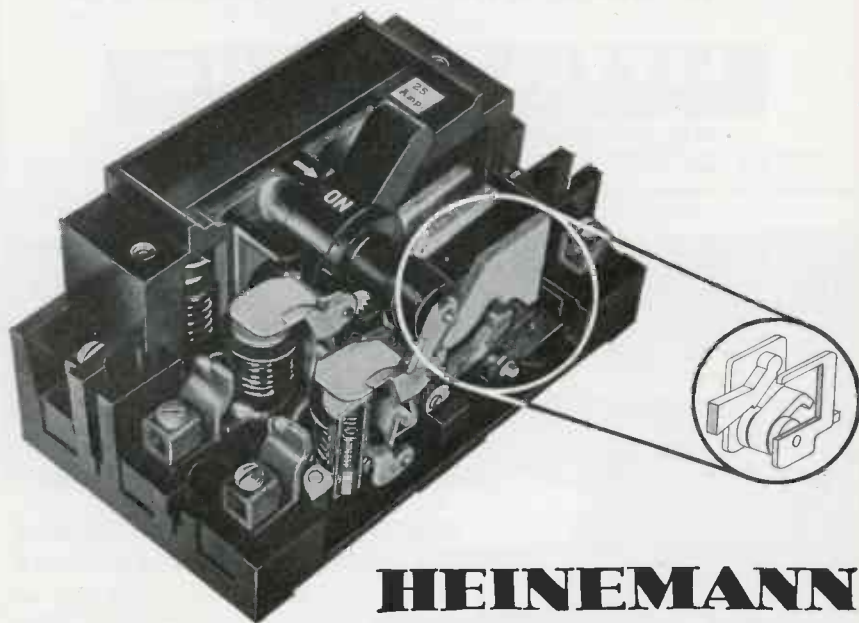

HEINEMANN MAGNETIC CIRCUIT BREAKERS

Employ High Speed Blowout

The stationary contact is coiled around an insulated iron core which connects the steel plates forming a U-shaped magnet. On overloads and short circuits the current flowing through the contact creates magnetic lines which force the arc into the arcing chamber and blow it out. As the value of the current to be interrupted increases the quenching effect becomes greater due to the intensified magnetic blowout field.

Send for Catalog 40 showing full line

HEINEMANN CIRCUIT BREAKER CO.
137 PLUM ST. - - - TRENTON, N. J.

THE "Give"
THAT CAN
TAKE IT!



Expansion-Contraction IN ACTION!

Anti-Vibration LITTELFUSES

Temperature changes sudden or slow, are hard on fuses. Littelfuse "Goose-neck" (illustrated) stands guard, instantly to protect element from cracking or crystallizing.

Other NEW exclusive Littelfuse features for outstanding fuse dependability are elements mechanically depolarized against vibration and shock at 90° twist, and fuse sealing by Locked Cap Assembly.



LITTELFUSE "GOOSENECK"
GREATLY ENLARGED
Spring-like forming at right of element shown above takes up expansion and contraction. Littelfuses of 5 amps., or less, have a spring and link element.

LITTELFUSE INC.

First in Aircraft Fuses — Pioneers in the Industry.

4732 RAVENSWOOD AVENUE, CHICAGO, ILLINOIS

202 ONG STREET, EL MONTE (LOS ANGELES SUBURB), CALIFORNIA

manufacturers will attempt to guide instrument production along standard lines as much as possible.

The performance characteristics outlined for instruments in the new standard are such that meters produced in accordance with it will withstand exposure to extreme variations in temperature and humidity and to the vibrations and shock encountered in the most severe military service except that of direct mounting on aircraft instrument panels for which the Army Air Forces and the Navy Bureau of Aeronautics have developed their own joint specifications. These performance requirements of the new ASA Standard are based for the most part on Navy Department Specification 17-I-12 (INT) with a few features added from Signal Corps Specification 71-515B.

Included in the standard also is a shock test for meters developed originally by the National Bureau of Standards and on which much work has been done by the Weston Electrical Instrument Corporation.

Drafting committee

The drafting group which participated in the detail work of drawing up the new standard included J. H. Miller of the Weston Electrical Instrument Corporation, J. M. Whittenton of the General Electric Company, D. A. Young of the Westinghouse Electric and Manufacturing Company, E. F. Seaman and B. R. Boymel of the Bureau of Ships, F. K. Priebe of Fort Monmouth Signal Laboratory and Sol Zaretsky of the Office of the Chief Signal Officer, as well as the authors.

The full ASA committee which passed on the technical details and adequacy of the new standard was headed by R. B. Shepard of the Conservation Branch of the War Production Board and included representatives of Bristol, DeJur-Amsco, General Electric, Hickok, Roller-Smith, Sangamo, Simpson, Triplett, Western Electric, Westinghouse, Weston, Bell Telephone Laboratories and the Edison Electric Institute. Government representation on the committee included the National Bureau of Standards; the Shipbuilding and Radio Divisions of the Bureau of Ships, the Production

READY
NOW!

NEW ALLIED 1943 BUYING GUIDE

FOR EVERYTHING IN
ELECTRONICS AND RADIO

CENTRALIZE YOUR PROCUREMENT
SAVE TIME... SPEED DELIVERY

FREE

SEND FOR
YOURS..
NOW!

Get this latest Allied Buying Guide for *everything* in Electronics and Radio. Procure all your needs from this ONE central source. Our large complete stocks of over 10,000 items assure you of prompt attention and quick delivery. Our staff is trained to help you with your problems... write, wire or phone Haymarket 6800, today!

NEW... ALLIED'S RADIO DATA HANDBOOK

Most essential formulas, charts, tables, standards and technical data on radio and electronics..... **25¢**

ALLIED RADIO CORP.

833 W. Jackson Blvd.
Dept. 32-D-3 Chicago



OVER 10,000
WARTIME ITEMS

Condensers	Switches	Rectifiers
Relays	Resistors	Sockets
Tubes	Rheostats	Wire
Test Equip.	Public Address	Generators
Transformers	Coils	Receivers
Photo Cells	Tools	Speakers

ALLIED RADIO

Division and the Office of the Chief Signal Officer of Headquarters, Services of Supply, U. S. Army; the Joint Aeronautical Board; the Signal Corps Ground Signal Service; and the Conservation, Radio and Radar, and General Industrial Equipment Divisions of the War Production Board.

WHEN ENGINEER IS BOSS

(Continued from page 93)

racks form a semi-circle in front of the control console. This assembly is of streamline pattern and the symmetry of its design bears evidence that beauty of appearance was not satisfied at the expense of technical efficiency.

The five panels shown in the illustration, the left of the console table, as follows: First rack is for extra supply of tubes which are arranged in neat array on special shelves designed for safety and ease of reaching them. Second rack contains the FM receiver and monitor equipment tuned to key station of air raid alarm system. Third rack has a turn table for emergency use which folds back when not in use. Fourth rack contains the speech input and dual amplifier, either one of which can be changed instantly without break in program. This panel also contains the wires and switch board control connecting the transmitter direct with the studios in New York City where also is located the executive offices of the Interstate Broadcasting Company, Inc. under which name the station operates.

The four panels located directly in front of the control table compose the exciter unit, the circuit consisting of two type 802 crystal oscillators which feed into type 802 first buffer and into type 805 IPA to pushpull type 810's. Four separate power supplies are provided, as follows: One type 5Z3 for the crystals, two type 866's delivering 500 volts for buffer and first stage audio. Two type 319's delivering 1500 volts supplies type 805 IPA and two type 810's and excites second audio stages of two type 807's also driver of four type 845's. The remaining power supply consists of two type 866's delivering 1000 volts



"TELL 'EM WE COULDN'T DO WITHOUT THE PARTS THEY'RE GIVING UP"

"Yeah, the folks back home are helping us plenty by giving up those radio and communication parts. See—over those hills! There's a bridge there. We just bombed hell out of it—cutting off an enemy tank column. With inadequate communications, we couldn't have done it!"

COMMUNICATIONS are vital in this war of rapid movement—where success demands "co-ordination" of widely dispersed units.

When a swift PT boat gets its radio orders to torpedo an enemy transport . . . when a bomber drops its eggs over a submarine base . . . when an allied tank column, keeping in contact by radio, speeds over Sahara's sands . . . Utah Parts are playing their role in this war of communications.

Soldiers of production build dependability into those parts at the Utah factory. Utah engineers plan it in the laboratories . . . as they pore over blueprints far into the night.

Constantly, research is going on at Utah . . . new and better methods of production are being developed . . . to help keep the ears of the armed forces open. Tomorrow—when peace comes—this research and experience will be reflected in the many civilian products being planned at the Utah Laboratories. Utah Radio Products Company, 850 Orleans Street, Chicago, Ill. Canadian Office: 560 King Street West, Toronto. In Argentine: UCOA Radio Products Co., SRL, Buenos Aires. Cable Address: UTARADIO, Chicago.



PARTS FOR RADIO, ELECTRICAL AND ELECTRONIC DEVICES, INCLUDING SPEAKERS, TRANSFORMERS, VIBRATORS, UTAH-CARTER PARTS, ELECTRIC MOTORS

TRIPLITT

Combat Line

PRECISION INSTRUMENTS



T-390



T-433

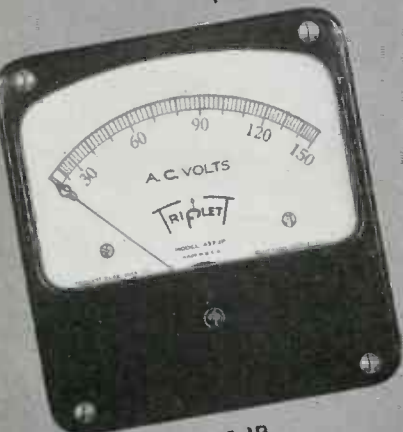

437-JP

TRIPLITT

A WORD ABOUT DELIVERIES

Naturally deliveries are subject to necessary priority regulations. We urge prompt filing of orders for delivery as expeditiously as may be consistent with America's War effort.

TRIPLITT ELECTRICAL INSTRUMENT CO.
BLUFFTON, OHIO

for the bias on the two type 341-AA modulator tubes. The final power amplifier consists of two type 892-R's in parallel with individual blowers, equipped with safety devices so that neither filament nor plate voltages can be applied unless blowers are delivering approximately 1000 cubic feet of air per minute. The modulator rack consists of first-audio stage of two type 77 tubes . . . second audio, two type 807's and driver stage of four type 845's parallel-pushpull to two type 341's and a similar blower arrangement as above described, is used on these tubes also as shown in photo. Automatic starting and protective relays are installed in all power circuit. No fuses are used and all switches are of the thermo-controlled type. Associated with the power equipment is a three phase high voltage transformer and reactor, all located in a fireproof vault at the rear of the transmitter racks.

Auxiliary transmitters

In the auxiliary one-kw transmitter racks, which occupy the right end of the circular array of panels, neon lamps are used across every fuse and relay employed in this circuit. Under normal use and load none of these lamps show any glow whatever, but when trouble arises in any part of the circuit, the lamp protecting that point will glow, although it takes no current from the circuit.

The high voltage rectifier unit consists of six type 321-A tubes in a three phase, full wave circuit of 8000 volts DC, filter condensers, condenser charging relay which functions through a resistance to eliminate the surge in the rectifier tubes. This relay operates a time delay circuit operating approximately two seconds after high voltage has been applied, after which shorting out charging resistor. A protective relay discharges condenser after the high voltage has been removed.

Sixty per cent of all broadcast-time at the studio is devoted to sending out classic and semi-classic recorded music, the only voice heard being that of the announcer who gives a preliminary, brief description of the music about to

be played. From 5 P.M. to midnight FM programs are also on the air through station W2XQR. Eighteen news programs are interspersed daily, except Sunday, in addition to other commentary subjects of timely and topical interest. Remote control to Town Hall carries the regular performance of "New Friends of Music" heard several times monthly. The station's own orchestra and chamber music groups are aired regularly.

Programming

A 40-page program booklet is issued once a month and mailed to a select audience, being the largest musical publication in the country by having a paid circulation of more than 23,000 copies. The booklet carries a small, uniform bit of advertising on the top or bottom of each page and the balance of the pages are devoted to a complete listing of all musical programs and talks scheduled for the coming month.

A library consisting of approximately 15,000 select musical recordings are filed and catalogued in fireproof cabinets. Associated with this large collection of music is an elaborate and systematic filing card system arranged according to composition, with duplicate cards according to time schedule, and another listing of each individual artist or orchestra. Each selection in the list of records has a card showing the title of the selection, the composer, the record number and the order in which the records are to be played as well as the names of the recording artists. Composition is broken down (if symphony) into movements and on the side of each record is listed its time in minutes and seconds, then a tabulation is kept of the date on which the selection is played.

Reliability and fidelity

In the overall design of the transmitter equipment, reliability of operation and high fidelity quality of signal output has been the express aim of the WQXR engineers. In the adopted program policy the ambition of the management has been the desire to give the listening public a sustained variety of the highest type of recorded music in

the belief that this kind of music, devoid of constant interruptions of commercial announcements was a service the people would appreciate.

When the idea was first suggested by Mr. Hogan it was universally discredited as being unsound, based upon the belief that not enough of the listening public were musically inclined or desired high class music, furthermore, that the operation of a broadcasting station with only the financial support of "approved" advertising was not practical. The faith of a practical radio engineer in high fidelity transmission of high quality music proves justified as the report is reviewed showing that the first circulation of the program booklet consisted of only 736 copies of a folded leaflet which has quickly grown to its present size and multiplied thirty-fold in circulation.

As to WQXR's selective policy of selling advertising time, it is sufficient to observe that the station has become a business success without having resorted to catch-penny advertising that its management feels would exploit WQXR's listeners. Forty or fifty substantial firms—like Bloomingdale's, Stromberg-Carlson, Botany Mills, Maxwell House, and Ward's—buy enough time to permit the station to maintain its program and advertising integrity.

WIBG'S STOP-LOOK & LISTEN STUDIOS

(Continued from page 97)

high-fidelity loud speaker whereby all studios and "remotes" may be monitored.

Acoustical treatment

Special consideration was given to the acoustical treatment of the walls and ceilings of the studios in view of the fact that a 30-to-15,000-cycle fidelity was desired and also because the ceiling heights were only nine and one-half feet high. Studio A has a floor space of 36 x 46 feet. Built in lights were arranged in the ceiling to give a diffused effect after it was found that the long tubular fluorescent lights caused an undesirable effect from the perforated side walls due to the angle by which the overhead lights

Speed Working Tools for Precision Operations

New and Old Workers find SPINTITE the fastest wrench for speedy assembly of small parts.

Standard sizes with hex sockets from 3/16" to 5/8". Knurled Round and Square Sockets available on special order.

SPINTITE works like a screw driver



T 51 Set in
Leatherette
Roll includes
7 SPINTITES
3 screw drivers
and chuck type
handle

STEVENS WALDEN, INC.

462 SHREWSBURY STREET

WORCESTER, MASSACHUSETTS, U. S. A.

Your Message To You . . .



Monarch developments in production and laboratory instruments have performed yeoman service for the leading radio manufacturers of America. Now, in war-time, we are cooperating with these same customers in developing and producing radio and electronic devices used in our war effort all over the globe.

If you need assistance in the field of radio or electronic developments, either for war production, or, if you are now thinking of peace-time possibilities, we will be very glad to talk things over with you.

MONARCH MFG. CO.

2014 N. Major Ave. Chicago, Ill.



No. 2 BLOWER HOUSING AND WHEEL

Plastic housing designed for operation in restricted spaces. Innumerable mounting possibilities. Motor requirements 1/100 H.P. various voltages. Weight only 4 1/2 ounces.

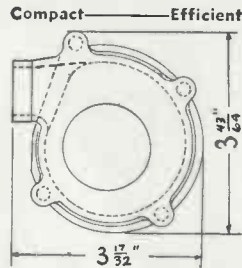

Write for complete specifications
L-R MANUFACTURING COMPANY
Torrington, Connecticut

JONES BARRIER STRIPS SOLVE MOST TERMINAL PROBLEMS

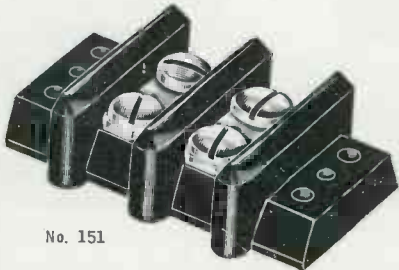

A compact, sturdy terminal strip with Bakelite Barriers that provide maximum metal to metal spacing and prevent direct shorts from frayed wires at terminals.

6 SIZES

cover every requirement. From 3/4" wide and 13/32" high with 5-40 screws to 2 1/2" wide and 1 3/8" high with 1/4"-28 screws.

Jones Barrier Strips will improve as well as simplify your electrical intra-connecting problems. Write today for catalog and prices.

HOWARD B. JONES
2300 WABANSIA AVENUE,
CHICAGO ILLINOIS

struck the open holes in the wall. A separate air conditioning system was installed for the studios only and special care was given to running the ducts in order to avoid picking up any stray noises. All air intake and return ducts are lined with sound-absorbing material which stops all noise created by the air flowing through the ducts.

The ground floor studio and control room are used especially in cases where prominent persons or local groups are being interviewed or the show has some significant public interest.

DECOUPLING FILTER FOR PLATE ISOLATION

(Continued from page 85)

A = forward gain of amplifier at lowest frequency considered.

The other quantities in (16) have been previously defined.

Equation (16) gives the time constant of the decoupling filter in terms of an allowable regenerative increase or degenerative loss in gain.

Designing the filter

The time constant derived in (16) is the product of two quantities.

$$T = R_f \times C_f$$

How large should the resistance and the capacity be to give us the desired product? R_f is limited by the plate supply voltage, i.e. the voltage drop, which we may allow to be wasted across it; it may be made about one-fifth of R_{L1} or greater depending on the supply.

$$R_f = \frac{E_f}{I_{p1} + I_{sc1}}$$

where:

E_f equals the maximum allowable voltage drop across R_f .

I_{p1} equals the plate current of the first tube at the operating point.

I_{sc1} equals the screen current of the first tube at the operating point.

Having determined R_f , the value of the capacity C_f is obtained from the relation

$$C_f = \frac{T}{R_f} \quad (17)$$

A slightly higher value than that obtained from (17) may sometimes be desirable for additional hum reduction.

¹ I R E Proceedings, Sept. 1942, "Circuit for neutralizing low-frequency regeneration and power supply hum."

² Radiofron Designer's Handbook, Third edition, pg. 29.

WHAT IS THE STANDARD ATTENUATOR?



VARIATEN
VARIABLE ATTENUATORS

CINEMA ENGINEERING CO.
1508 WEST VERDUGO AVENUE
BURBANK, CALIFORNIA



Send for our new Catalogue,
listing the largest variety of
attenuators ever compiled.

PLASTIC NAME PLATES

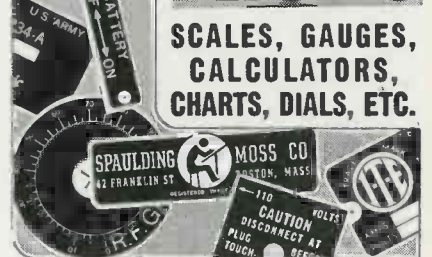

SCALES, GAUGES,
CALCULATORS,
CHARTS, DIALS, ETC.

- Impervious to moisture, grease, oils, acids, alkalis.
- Printing guaranteed not to wash or rub off.
- Non-inflammable, non-corrosive plastic.

SAMPLES AND ESTIMATES GLADLY SUPPLIED ON REQUEST.

WRITE DEPARTMENT E.I.

THE HOPP PRESS, INC.
PRINTING - FABRICATING - FORMING
460 W. 34th STREET, N. Y. C.
ESTABLISHED 1893

ELECTRONICS AND IONICS EXPLAINED

by DR. JOSEPH SLEPIAN

Associate Director of Research for Westinghouse



Electronics, electronic engineering! These are words which fire the popular imagination today. Radio and television, the talking movie, the door-opening electric eye, the dentist's X-ray tube, the new fluorescent lamps, all these, evident in our daily lives, are said to be products of the science of electronics. The press, and our electrical manufacturers hint of marvels accomplished in the war, and the revolutionary devices to come after the war, all out of this science of electronics.

What is this science of electronics? Perhaps no very exact answer can be given at this time. In technical or scientific literature a new word is given a sharp, precise meaning by definition by those who first use it, but a popular word may have initially only a vague meaning, which becomes more definite only after considerable usage. Gradually, and partly through discussions such as I am offering in this essay, a meaning emerges upon which most people will agree.

Consider a moderately well educated young man, and let us follow him in his explorations in trying

Address before the Science Talent Institute being attended by 40 winners of the Second Annual Science Talent Search competing for the Westinghouse Science Scholarships. Hotel Statler, Washington, D. C.

to arrive at a good definition of the "science of electronics," or "electronic engineering." He has already met the electron. He knows that its existence was established by J. J. Thomson in the 1890's. He knows that it carries a negative charge of 4.77×10^{-10} electrostatic units, and has a mass only 1/1830th of the mass of the hydrogen atom. He knows, also, that its dynamics is quite different from that of bodies in everyday life, that it must be regarded as a wave, as well as a particle, and that a newly developed

"wave-mechanics" can describe its motions where the older Newtonian mechanics fails.

His first impulse is perhaps to say that the "science of electronics" deals with those phenomena in which the electron enters, and that "electronic engineering" deals with apparatus or machines in which electrons play a necessary part. But he then immediately realizes that such a meaning is too comprehensive. He has learned that the electron is omnipresent, that it is a part of every electrical manifes-

EXTENDED RANGE SIGNAL SHIFTER!



*With Meissner's
newly developed
general coverage
series plug-in
coils . . . cover
frequencies
from 1000 kc.
to 16,500 kc.*

MEISSNER SIGNAL SHIFTER permits instant frequency change in any given band . . . right from the operating position.

Your crystal procurement problems are solved when you install a Meissner Signal Shifter! . . . provides continuous coverage of a frequency range from 1000 kc. to 16,500 kc. without any sacrifice in stability . . . NO CRYSTALS REQUIRED!

The Meissner Signal Shifter is a variable frequency exciter of exceptional stability . . . may be used alone as an auxiliary or "Short-Haul" C-W transmitter. All tuned circuits are gang-controlled by a high quality precision vernier dial.

See your Meissner distributor or write

Meissner
MOUNT CARMEL, ILLINOIS

"PRECISION-BUILT PRODUCTS"

Goat
ELECTRONIC TUBE
PARTS AND SHIELDS

Small Parts
of the
BIG
WAR
JOB!

Goat Metal Stampings
INC.
Division of THE FRED GOAT CO., INC.
314 DEAN STREET, BROOKLYN, N. Y.
Goat has meant
Accuracy since 1800

IN THE Service!

SNYDER
MANUFACTURING CO.
PHILADELPHIA, U. S. A.

ANTENNAE & ASSOCIATED PRODUCTS

tation of matter, and even of those manifestations which are not ordinarily thought of as electrical. He has come to believe that so commonplace a matter as the conducting of a current by a metal wire, is accomplished by the motion of tremendous numbers of these tiny electrons along the wire. With his first definition he would then be making the "science of electronics" and "electronic engineering." He would be making an electric motor or an electric toaster, "electronic apparatus."

Hot filament

He then feels the need of a drastic restriction in his definition, and perhaps proceeds next to examine a tube of his radio, which he is very sure is an "electronic apparatus." Such a tube has in it a hot filament from which electrons emerge, a highly evacuated space, in which these electrons can move about under the influence of electric fields without encountering grosser matter, and various electrodes, grids and plate for creating the electric fields to cause the motion of these free electrons.

He is now ready to consider this definition. An "electronic apparatus" is one which accomplishes the purpose for which it was constructed, through the intermediary of electrons, relatively free from the grosser matter to which they are ordinarily bound. The "science of electronics" then, deals with free electrons, the means for setting them free, their motions when free, and the effects they can produce by being acted upon while free.

Free electrons

This definition seems quite good. For example, the free electrons in the radio tube, through the charges they carry, and the control the grids exert upon them, can change direct current into high frequency alternating and vice-versa, so the radio tube is an "electronic apparatus." The free electrons in the X-ray tube are accelerated to high kinetic energy, while free, and strike their target, producing Roentgen rays. The X-ray tube is an "electronic apparatus." Quanta of light arriving at the cathode of

the photo-tube set free electrons to carry their charge to the anode. The "electric eye" or photo-tube is an "electronic apparatus." Free electrons in the fluorescent lamp strike mercury atoms so violently that they are excited, and emit ultra-violet light, which in turn excites the material on the glass to fluorescence. The fluorescent lamp is an "electronic apparatus."

But the young man looks again at the metal wire, and pauses. Do not the electrons in the wire move readily when acted upon by an electric field? Are they not, then, free? Again the electric motor and electric toaster intrude. Are they also "electronic apparatuses"? He is back to his original dilemma.

The two freedoms

Somehow, the young man feels, the electrons in the "electronic apparatus" are free in a different sense and in a different way than the electrons in the metal wire. And by examining the modern theory of the atom, and the modern theory of the electronic states of a metal, he begins to see how he may distinguish between the two kinds of freedom.

An isolated atom of an element in its normal state, he knows, according to Rutherford, Bohr, and their followers, has a positively charged nucleus surrounded by a swarm of electrons, and these electrons are in a kind of regular motion about the nucleus. Bohr regarded these electrons as moving in special radiationless orbits. But while moving in these orbits, and thus in a sense free, the electrons remain always close to the nucleus. Thus, they still remain bound. Impressed electric and magnetic fields will alter the motion of electrons about the nucleus, as is shown by the Stark and Zeeman effects. But the orbits are only shifted slightly or perturbed by the fields. They continue to surround the nucleus closely. The change in energy of the electrons with the largest attainable impressed fields is only a fraction of a volt, while their normal energies are many volts.

Now let two nuclei with their accompanying swarms of electrons, approach each other. When about

Luxtron

PHOTO ELECTRIC CELLS

IN **ANY** . . .

Size-Type-Shape
Capacity

EQUAL TO **ANY** . . .
REQUIREMENTS

The widest range of scientific and industrial requirements can be met by Luxtron Cells—the Cells that meet the stringent requirements of the Army and Navy. For measurements, analysis, indication, metering, control, signal, inspection, sound reproduction, etc. Luxtron Units can also be produced to meet special needs.



USED TO

PRE-TEST

Bomber Pilots

**IN STRATOSPHERE
CHAMBERS**

Luxtron Photo-Electric Cells in Stratosphere Chambers, where pilots are pre-tested, have to meet the most severe conditions of cold, humidity, vibration. The fact that they satisfy the Army and Navy requirements is proof that they can meet the most particular specifications of all commercial and industrial applications.

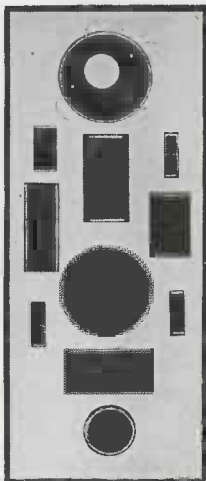

• Write for special illustrated literature with complete technical data. We are at your service for consultation on special problems.

Luxtron*

PHOTO ELECTRIC CELLS

BRADLEY LABORATORIES, INC.
81 MEADOW ST. • NEW HAVEN, CONN.

10⁻⁸ cm apart, the orbits of the outermost electrons begin to overlap. A new set of orbits form, in which the outermost electrons now circulate around the two nuclei. Thus the outermost electrons have become free. Such an outer electron is no longer bound to a single nucleus, but can and does move from the neighborhood of one nucleus to the neighborhood of the other.

Now, by building up a chain of these nuclei, with their overlapping electron swarms, the young man in search of a definition of "electronic apparatus," begins to see what happens in a metal, and why a metal wire may not be an "electronic apparatus." In the metal wire the electrons become free only by being able to follow orbits which go from nucleus to nucleus. They are thus still bound in their freedom. They remain always within about 10⁻⁸ cm from some nucleus.

The young man now triumphantly proposes his more refined definition of the "science of electronics." The "science of electronics" deals with electrons which are free in the sense of being substantially at much greater distances from the nuclei of atoms than the radii of the outermost stable orbits of the normal atom. That is, free electrons, in the sense developed here, are farther away from nuclei than many times 10⁻⁸ cm. In the usual radio tube, for example, the electrons in the vacuum space are generally more than 10⁻⁴ cm away from any atom. They are free. In the metal wire, however, the conduction electrons are never more than a few times 10⁻⁸ cm away from a nucleus. In spite of their mobility, they are not free in the sense used here.

Setting electrons free

The "science of electronics" is the science of these now sufficiently well defined free electrons.

It deals with the means for setting electrons free; thermionic emission, photoelectric effect, secondary emission, etc. It deals with the properties of free electrons, their motion in electric and magnetic fields, as in the electron microscope, their space charge effects, etc. It deals with effects produced

by free electrons acting on other matter, excitation, and ionization of atoms by collision, generation of X-rays, excitation of fluorescence, activation of a photographic film. It deals with the ways free electrons lose their freedom, recombination with positive ions, attachment to neutral molecules to form negative ions, etc. "Electronics engineering" is the applied "science of electronics." It deals with the development, design, and application to useful purpose of electronic apparatus, that is apparatus employing electrons free in the sense which has just been described.

The "free electrons" of an electronic apparatus, must of course have space in which to exercise their freedom, so every electronic apparatus has in it a vacuum or gaseous space in which electric current is carried by free electrons. This is clear because in any liquid or solid element of a circuit the atoms or nuclei are so close together electrons cannot be free there in the sense defined above. This suggests a bulky equivalent alternative definition of an "electronic apparatus." An "electronic apparatus" is a device in which electric conduction current is carried through a vacuum or gaseous space. This form of definition has the advantage of avoiding theory in its formulation, and referring only to objects which can be directly and immediately observed.

New conceptions

According to the two equivalent definitions, "electronic apparatus" obviously include the various vacuum tube detectors, amplifiers, oscillators of radio, X-ray tubes, photo-tubes, ultra-violet germ-killing lamps, fluorescent lamps, neon signs, thyratrons, and ignitrons. But they also include devices which in the past we have not thought of as electronic devices. Electric switches which use the electric arc for safely interrupting power circuits, spark gaps in lightning arresters and similar devices for protecting electric circuits, spark plugs for igniting in proper sequence the explosive mixtures in internal combustion engines, electric arc welders, electric arc furnaces, the prescription for



WOMEN AT WAR

... Saving Man Hours
and Critical Materials

No delay waiting for dies — parts ready quicker — deliveries speeded up — all to bring the Victory sooner! Women are rapidly taking a major place on the industrial front. DI-ACRO Precision Machines — Shears, Brakes, Benders — are ideally suited for use by women in making duplicated parts accurate to .001" — DIE-LESS DUPLICATING. Thousands of DI-ACRO Machines are now in use in War plants. Get the whole story — write for catalog — "Metal Duplicating Without Dies."



O'NEIL-IRWIN MFG. CO.
348 EIGHTH AVE. SOUTH • MINNEAPOLIS. MINN.



Keep your eye
on this lad
Mr. Manufacturer

A FEW MONTHS AGO he was just a normal, untrained, happy-go-lucky kid. Today he's been well trained by Uncle Sam's Signal Corps into a competent technician, fit to take the responsibility on which hundreds, maybe thousands of lives depend. When he comes marching up Broadway in a shower of ticker tape, be ready to grab him — he'll be a valuable man.

And if he tells you that communications and electrical equipment made here at C. T. & E. is the last word in advanced engineering and rugged dependability, pay heed — you'll be listening to the voice of experience. You see, there's "Connecticut" equipment on the job almost everywhere United Nations forces are fighting.



CONNECTICUT TELEPHONE & ELECTRIC DIVISION



MERIDEN, CONNECTICUT

*dependable
durable
efficient*

American Beauty

ELECTRIC SOLDERING IRONS

Preferred by those who measure the value of a tool by the service it renders. Soldering irons are made in 5 sizes and for low as well as standard voltage.

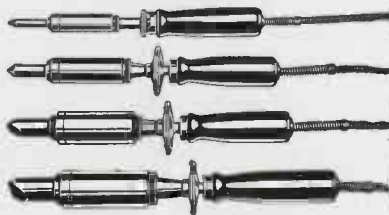

TEMPERATURE REGULATING STAND

A thermostatically controlled stand for regulating the temperature of an electric soldering iron when at rest. The thermostat is adjustable for various heats.

Write for Catalog Sheets.

AMERICAN ELECTRICAL
HEATER COMPANY
DETROIT, MICHIGAN

8-42 101AE



Important Announcement

WAR AND POST-WAR MARKETING NUMBER

June

PLANNED MARKETING is the coming phase of electronics—the next big need of the industry in war and post-war planning—the growing concern of marketing and engineering executives.

Not knowing how soon there will be a sharp curtailment in government buying, or how far the war influence will outrun the war itself, thoughtful executives are eager to get reliable data on which marketing plans and policies may be based.

Marketing, therefore, will be an outstanding editorial feature of **ELECTRONIC INDUSTRIES** in June.

Charts, statistics, surveys, opinions of manufacturers and market analysts, etc., will furnish ideas, experiences, methods and yardsticks. This material will show:

What the market is composed of.

Where it is located.

Channels and methods of sales and maintenance.

The engineer's place in future marketing.

The extent of intra-industry selling.

The relative importance of the industrial electronic market.

The effect of war engineering and standardization.

... with the usual balance of industrial and technical electronic material.

Because this great issue will reach 99 per cent of the market's buying power and all known sales outlets, it provides a rare advertising opportunity to stress your present and future marketing program.

AN EARLY RESERVATION IS ADVISABLE

NEW YORK
480 Lexington Avenue
Telephone PLaza 3-1340

**ELECTRONIC
INDUSTRIES**

CHICAGO
201 No. Wells Street
Telephone Randolph 9225



• Dalis is supplying radio and electronic materials to many branches of the armed forces, war plants, sub-contractors, laboratories, training schools, etc.

Ample stocks on hand provide prompt shipment on many items. And if required items are not in stock, Dalis go-gets 'em for you in shortest possible time.

• Try Dalis — write, wire or 'phone . . .

H. L. DALIS, Inc.

Distributors of
RADIO & ELECTRONIC SUPPLIES
17 Union Square • New York, N. Y.

Phones: ALgonquin 4-8112-3-4-5-6-7

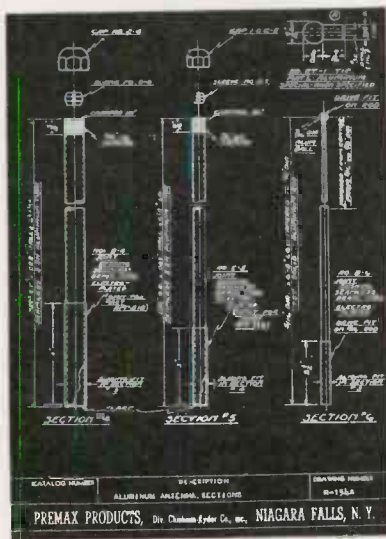

Take a Page from Premax ANTENNA DESIGNS

Tubular Metal Antennas to meet the needs of the Armed Forces on land and sea. Send for Bulletin of Antennas and Mountings.

Premax Products

DIVISION OF
CHISHOLM-RYDER CO., Inc.
4312 Highland Avenue, Niagara Falls, New York

electrically cleaning air of dust, these are all electronic devices according to the definitions developed above.

Shall we try to modify the definition so as to exclude these devices? No, that is not possible. Rather we must accept these familiar things as truly electronic apparatus, and even more we must expect confidently that the "science of electronics" now and in the future will make clearer the manner of operation of the devices, and will teach us how to make better these devices. In fact, some of the "next" things in electrical engineering will be great developments and improvements in these devices through "electronic science."

Enter ions

When we examine these electronic devices, we find that they fall into two rather definite classes. All employ free electrons, but some make important use also of positively charged atoms or molecules of the gas through which the electrons pass. These positively charged atoms or molecules are called ions, so perhaps the devices using them might be called ionic devices, or perhaps still better electro-ionic, indicating that they use both free electrons and ions.

The ions in an ionic or electro-ionic device are generally produced by the free electrons themselves. If the circumstances are such that free electrons acquire ten to twenty volts of kinetic energy and then strike neutral molecules, the neutral molecules are broken up into positively charged ions, and other free electrons. Conversely, as we shall point out presently, the ions may produce free electrons, so that a new possibility arises, namely, the self-maintaining gas discharge, as in the glow in the neon sign, the quick acting spark in the lightning arrester, the energetic arc in the electric circuit breaker, and the silent cleansing discharge in the precipitron.

The ions in an electro-ionic device generally exercise a very useful function in neutralizing the space charge of the free electrons. When large numbers of free electrons are introduced into a space, the electrical effects of their

GOOD NEWS

for
**Radio Engineers
and Technicians**

NOW—

CATHODE RAY PATTERNS SUMMARIZED in ONE book!

39 pages
Over 100 Charts

\$1.50

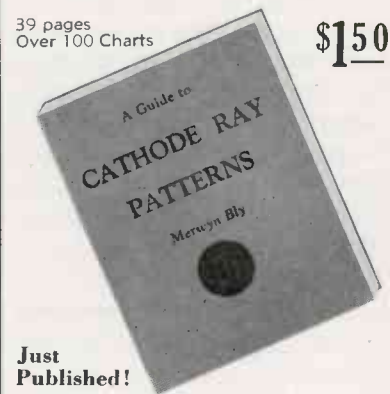

Just
Published!

A Guide to CATHODE RAY PATTERNS

by **MERWYN BLY**

A real contribution to radio literature. The "Guide" presents under ONE cover a "sketch and caption" summary of cathode ray patterns in ready-to-use form that engineers and technicians appreciate. All patterns produced for the "Guide" were developed with conventional amplifiers and oscillators and viewed on a small oscilloscope using a standard circuit. A section on simple graphic analysis is included.

CONTENTS

Phase Determination • Frequency Determination • Modulation Patterns • Sine-Wave Testing • Square-Wave Testing • Resonance Curves • Vacuum Tube Characteristics • Miscellaneous Patterns • Graphic Analysis

5 DAYS' FREE APPROVAL

JOHN WILEY & SONS, INC.
440 Fourth Avenue, New York, N. Y.

Please send me a copy of Bly's GUIDE TO CATHODE RAY PATTERNS on five days' approval. At the end of that time, if I decide to keep the book, I will remit \$1.50 plus postage; otherwise I will return the book postpaid.

Name
Address
City and State
Employed by

EI-4-43

charges are additive, and large electrical fields are produced. These fields react on the motion of the electrons, and the net effect is that large currents can be carried by free electrons above, only by using excessively large impressed voltages. If, however, a corresponding number of positive ions are interspersed among the electrons, the additive effect of the charge on the electrons is neutralized, and large currents may be carried by quite low impressed voltages. For example, in the ignitron tubes supplying the direct current for making aluminum and magnesium, thousands of amperes are carried with a voltage of less than twenty volts. Without the space charge neutralizing effect of the positive ions, the use of free electrons for rectifying large alternating currents would be practically impossible.

How ions help

Another useful function of ions in electro-ionic devices, is their action in setting free electrons at the cathode, so that a hot filament is

not a necessary element in an electro-ionic tube. The cathode ray tubes which J. J. Thomson used in discovering the electron, and the tube which blackened Roentgen's photographic plate had in them no thermionic filament. But ions in the gas striking the cathode set free the electrons which started the electronic age.

When the current density at the cathode is sufficiently large, a new phenomenon appears, the so-called cathode spot, which sets free enormous numbers of electrons from the otherwise unheated cathode. Thousands of amperes of free electrons per square inch emerge from the cathode spot with a voltage drop of less than twenty volts. The detailed mechanism of the cathode spot is still not known, but there is little doubt that the positive ions are an absolutely necessary part of this mechanism.

It is extremely easy to produce such a cathode spot. Davy in 1808 separated a pair of carbons in a circuit carrying a few amperes, and produced the dazzling electric

arc, with its free electrons, ions, and cathode spot. Thus an electro-ionic device appeared for scientific experiment nearly a century before the discovery of the electron. Also, anteceding the electron discovery, the electrical industry started street lighting with electric arcs, and before the knowledge of the free electron was widespread, was using mercury arcs in glass tubes for supplying the direct current for the series arc street-lighting systems. Thus the electrical engineers of that time were practicing "electronic engineering" without knowing it, like the famous gentleman who was surprised to find that he had been speaking prose all his life without knowing it.

Complex theory

But while these electro-ionic devices are very simple in their physical structure, enough has been said to indicate that their theory is complex, and that they present problems upon which "electronic science" has shed light, but still has not solved. We may confidently ex-



ALLIANCE dynamotors and band-switch motors are engineered to stand up and take it. They give it back, too, twenty-four hours a day in Alaska and Africa, from Greenland to Gibraltar — gremlins or no gremlins.

Built with quality materials, by precision methods to exact specifications, Alliance dynamotors and band-switch motors are dependable. Their sound engineering gives economy in construction and operation.

The everyday use of Alliance motors under today's conditions proves "no motors better built or better engineered."



DEPENDABILITY proved by constant service under all conditions.



PRECISION proved by the wide variety of exacting performance.



ECONOMY proved by low initial cost and reliable operation.

ALLIANCE MANUFACTURING CO.
ALLIANCE, OHIO

Save with WAR BONDS

\$4 back for every \$3 invested

50 million Americans own war bonds. 25 million use the Payroll Savings Plan. More buyers and more Payroll Plans are needed.

If you haven't got a Payroll Savings Plan in your factory, start one TODAY.



This space is a contribution to America's all-out war effort by
ELECTRONIC INDUSTRIES

pect, however, that these problems will be more and more resolved by the electronic scientists and engineers of the future. And with the resolution of these problems, far-reaching improvements of the older electro-ionic devices will result, as well as the invention and development of entirely new devices.

To consider a few specific instances, let us regard first the homely electric switch. In the mid 1920's the expansion of the electrical power systems was threatened with an impasse because the limit in interrupting capacities of the circuit breakers then available had been reached. The arcs formed between the separating contacts in switches in these large current high voltage systems could not be extinguished by the available means. Then in 1928 one of the first of a series of revolutionary developments was announced by an electrical equipment manufacturer under the name De-ion, thus bringing out into the open that the switch was now an electro-ionic device, and that its future progress depended on the contributions which would be made to it by electronic science. The conductivity of the electric arc was recognized as due to presence in the gas space of free electrons and ions, and the problem of the proper extinction of the arc at the proper moment, was the problem of de-ionizing, or making disappear at the proper moment, and sufficiently rapidly the free electrons and ions which the arc itself engendered. The development of de-ionizing means, while guided by electronic theory, is still largely empirical. In the future much of this empiricism may be removed by electronic science, and new electro-ionic switches of extraordinary capacity may be expected.

Ignitron's history

The ignitron is another example of how modern electronic science revolutionized an older electro-ionic device. The mercury arc rectifier was invented by Peter Cooper-Hewitt in 1903, shortly after the discovery of the electron. Cooper-Hewitt did not talk of free electrons, and their emission from the cathode, but spoke of a vague "cathode reluctance" to explain the rec-

tifying effect he had found. This was his way for describing the fact that emission of free electrons from the cathode is a necessary part of conducting current through mercury vapor, and that by providing one electrode from which electrons are freely emitted, and another from which such emission is lacking, a rectifier of alternating current is obtained. A cathode-spot, initiated by breaking contact between the mercury pool cathode and an auxiliary electrode, was Cooper-Hewitt's method of producing electron emission from the cathode.

Under the guidance of electronic science, the mercury arc rectifier in the 1920's was developed up to large sizes, and particularly in Europe displaced dynamo-electric converters for railway electrification and in the electro-chemical industry.

Heavy current uses

About 1930, the use of stainless steel and light metals was rapidly expanding, particularly in transportation equipment, and methods for rapid electrical welding were devised. For welding of such metals it is necessary to use a rapid sequency of accurately measured pulses of electric current, accurately timed. Mechanical switches, because of their inertia, were not practical for controlling these current pulses. It was very natural by this time to turn to electronic science for the answer, and because of the large currents involved, an electro-ionic type of tube was indicated and particularly the mercury arc tube, with its indestructible mercury pool cathode made electron emissive by means of a cathode spot.

However, the only reliable means for starting a cathode spot known at that time was that of mechanically breaking a circuit comprising the mercury pool and an auxiliary electrode, and again mechanical inertia introduced insuperable difficulties. What was wanted was a purely static means for initiating the cathode spot at great frequency and under perfect control.

Electronic science gave a beautiful solution to this problem. A rod of high resistance material was stuck down into the mercury, and



Found

Finding certain radio parts today can be equally as difficult as locating the proverbial needle-in-a-haystack. Generally, persons intimately associated with haystacks are more apt to succeed in finding the elusive needle . . . in some portion of their anatomy.

HARVEY, through lengthy and constant affiliation with the radio manufacturing sources of supply, has developed an almost instinctive faculty for locating facilities that may be in a position to furnish the components or equipment you desire.

May we help you?

HARVEY
RADIO COMPANY
103 WEST 43 ST. NEW YORK, N.Y.

Advertisers' Index

	Page		Page
ACE MFG. CORP.	114	JANETTE MFG. CO.	133
AEROVOX CORP.	127	JEFFERSON ELECTRIC CO.	139
AIRCRAFT PRODUCTS CO.	141	JONES, HOWARD B.	150
ALDEN PRODUCTS CO., INC.	131	KEN-RAD TUBE & LAMP CORP.	126
ALLIANCE MFG. CO.	158	LAFAYETTE RADIO CORP.	144
ALLIED RADIO CORP.	146	LAPP INSULATOR CO., INC.	8, 9
AMERICAN AUTOMATIC ELEC. SALES CO.	10	LITTELFUSE, INC.	146
AMERICAN ELECTRICAL HEATER CO.	155	L-R MFG. CO.	150
AMERICAN LAVA CORP.	33	MALLORY & CO., INC., P. R.	Cover 2
AMERICAN TRANSFORMER CO.	117	McELROY MFG. CO.	123
AMPERITE CO.	140	MECK INDUSTRIES, JOHN	26
ANACONDA WIRE & CABLE CO.	45	MEISSNER MFG. CO.	151
BARKER & WILLIAMSON	119	MICRO SWITCH CORP.	39
BLILEY ELECTRIC CO.	140	MILLEN MFG. CO., INC., JAMES	128
BOONTON RADIO CORP.	138	MONARCH MFG. CO.	149
BRADLEY LABORATORIES, INC.	154	NATIONAL UNION RADIO CORP.	153
BURKE ELECTRIC CO.	134	NORTH AMERICAN PHILIPS CORP.	125
CALLITE TUNGSTEN CORP.	122	OHMITE MFG. CO.	111
CANNON ELECTRIC DEVELOPMENT CO.	120	O'NEIL-IRWIN MFG. CO.	155
CAPITOL RADIO ENGINEERING INSTITUTE	132	PERM-O-FLUX CORP.	137
CENTRALAB	2, 3	PIONEER GEN-E-MOTOR	134
CINEMA ENGINEERING CO.	150	PREMAX DIV., CHISHOLM-RYDER, INC.	157
CLARE & CO., C. P.	24	RADIO CITY PRODUCTS CO., INC.	46
CLAROSTAT MFG. CO., INC.	130	RADIO SPECIALTIES CO.	133
CONNECTICUT TELEPHONE & ELECTRIC	155	RAYTHEON MFG. CO.	29, 136
CORNELL-DUBILIER ELECTRIC CORP.	22	RCA VICTOR DIV., RADIO CORP. OF AMERICA	Cover 4, 7, 15
CORNING GLASS WORKS	36, 37	RECORDIT CO.	143
CREATIVE PLASTICS CORP.	136	REMLER CO., LTD.	138
CRYSTAL PRODUCTS CO.	6	RIDER, JOHN F.	133
DALIS, INC., H. L.	157	ROLA CO., INC.	20
DAVEN CO.	Cover 3	SHURE BROTHERS	34
DEUTSCHMANN CORP., TOBE	1	SIGMA INSTRUMENTS, INC.	124
DIAL LIGHT CO.	143	SNYDER MFG. CO.	152
DUMONT LABORATORIES, INC., ALLEN B.	31	SPRAGUE SPECIALTIES CO.	38
EITEL-McCULLOUGH, INC.	35	STANDARD TRANSFORMER CORP.	42
ELECTRONIC LABORATORIES, INC.	13	STEVENS WALDEN, INC.	149
ELECTRONIC MECHANICS, INC.	19	STROMBERG-CARLSON TELEPHONE MFG. CO.	129
ELECTRO-VOICE MFG. CO., INC.	14	STRUTHERS DUNN, INC.	23
ERIE RESISTOR CORP.	28	STUPAKOFF CERAMIC & MFG. CO.	108
ERWOOD CO.	144	SYLVANIA ELECTRIC PRODUCTS, INC.	107
FELKER MFG. CO.	44	TERMINAL RADIO CORP.	133
GALVIN MFG. CORP.	40	THERMADOR ELECTRIC MFG. CO.	112
GENERAL CERAMICS & STEATITE CORP.	27	THORDARSON ELECTRIC MFG. CO.	4
GENERAL ELECTRIC CO.	11, 21, 113	TRIPLETT ELECTRICAL INSTRUMENT CO.	148
GENERAL RADIO CO.	118	TUNG-SOL LAMP WORKS, INC.	43
GENTLEMEN PRODUCTS	143	TURNER CO.	116
GOAT METAL STAMPINGS, INC.	152	UNITED ELECTRONICS CO.	12
GUARDIAN ELECTRIC MFG. CO.	41	UNITED TRANSFORMER CO.	48
HALLICRAFTERS	18	U. S. TREASURY	158
HARVEY RADIO CO.	159	UTAH RADIO PRODUCTS CO.	147
HAYDU BROTHERS	115	WALKER-JIMIESON, INC.	133
HEINEMANN CIRCUIT BREAKER CO.	145	WARD LEONARD ELECTRIC CO.	32
HEWLETT-PACKARD CO.	25	WARD PRODUCTS CORP.	135
HIPOWER CRYSTAL CO.	143	WESTERN ELECTRIC CO.	5, 143
HOPP PRESS, INC.	150	WESTINGHOUSE ELEC. & MFG. CO.	16, 17
HYTRON CORP.	105	WILEY & SONS, INC., JOHN	157
INTERNATIONAL NICKEL CO., INC.	47	WINCHARGER CORP.	142
INTERNATIONAL RESISTANCE CO.	30		
INTERNATIONAL TEL. & TEL. CORP.	121		

While every precaution is taken to insure accuracy, we cannot guarantee against the possibility of an occasional change or omission in the preparation of this index.

CALDWELL-CLEMENTS, Inc.

Publishers of

ELECTRONIC INDUSTRIES
ELECTRONIC YEAR BOOK
& ENGINEERING DIRECTORY
INDUSTRIAL ELECTRONICS
RADIO RETAILING TODAY
THE RADIO YEAR BOOK

NEW YORK
480 Lexington Ave.
Telephone
PLaza 3-1340

CHICAGO
201 N. Wells St.
Telephone
Randolph 9225

current passed down through the rod into the mercury. Analysis of electrical conditions at the junction of the rod with the mercury indicated that there would be there a large concentration of current, and an intense field, just the conditions for starting a cathode spot. Experiment bore out this expectation. Sure enough, when a few amperes passed down the resistance rod, a cathode spot appeared on the adjacent mercury. This could be done as quickly and repeatedly as desired.

The small current for thus initiating the cathode spot could be readily handled by a more usual thermionic, grid-controlled, electro-ionic tube. After the cathode spot was formed, thousands of amperes needed by the weld would pass through the mercury arc tube. Thus the ignitron was born.

These examples are only a few of the instances where electronic science is modifying and improving the apparatus of the electric-power industry. We may be quite sure that the next steps in electrical engineering will include further improvements in electro-ionic apparatus, and wider applications.

Farm-Radio Battery Production Promised

A certain amount of relief from the present shortage in farm-radio batteries can now be expected, through the adjustment and re-scheduling of battery production announced March 26th by the WPB Consumer Durable Goods Division. The Division stated that re-scheduling and temporary lay-offs in the battery requirements of other services will permit transfer of facilities and materials to farm-radio battery production.

Lack of radio batteries has been reported as most acute in farm areas, which are solely dependent upon battery set reception, where as many as one-third of the farm battery radios have been declared to be inoperative.

Critical aspects of the zinc situation, however, have prevented any definite plan or figures being formulated at this time by WPB in its efforts to step up battery production.



"Down-to-Earth"

Because every effort in the design and construction of DAVEN components and equipment has always been devoted toward the one, elementary objective: **efficient operation**, our products are universally recognized for their absolute dependability.

Where performance is the prime consideration, specify DAVEN attenuators.

THE DAVEN COMPANY

158 SUMMIT STREET

NEWARK, NEW JERSEY



*Do Things Faster,
More Accurately,
More Economically*

THE ELECTRONIC WAY!

Communicating • Measuring • Checking
Analyzing • Actuating • Protecting
Testing • Detecting • Matching • Sorting
Controlling • Magnifying • Heating
Rectifying • Counting • Transforming
"Seeing" • "Feeling"

The following RCA Tube publications are available from Radio Corporation of America, Commercial Engineering Section, Harrison, N. J.

RCA PHOTOTUBES (booklet on request)
RCA POWER AND SPECIAL PURPOSE TUBES (catalog on request)
RCA TRANSMITTING TUBE GUIDE (Guide 35c net)



Modern Measurements . . . without mechanical movement or its limitations

Perhaps no single type better illustrates the indispensable nature of the Electronic Vacuum Tube throughout science and industry than RCA Cathode-Ray Tubes.

Used in Oscillographs, these tubes are pacing the way to new, higher standards of measuring anything or any phenomena that can be transformed into electrical impulses—and doing it without mechanical movement and the limitations inherent in such movement. Every day, RCA Cathode-Ray Tubes are proving unexcelled in the development and production of war materiel. They are being used in such widely diverse fields as acoustics and vibration studies . . . studies of magnetic phenomena . . . water-leak tests . . . geological and geophysical investigations . . . manufacturing operation tests . . . ignition timing and adjustment work . . . medical and

biological research . . . engine-pressure indications . . . power plant maintenance . . . aeronautical engine synchronization . . . and a host of others, including their better-known applications in communications, radio and servicing.

Other RCA Tube types, from Phototubes to Power Tubes, are doing equally important jobs contributing to the war effort along entirely different lines—and doing them so well that today's "Do It the Electronic Way" becomes far more than a slogan. It stands as a challenge to every civilian and war industry to handle countless tasks faster, more accurately, or more economically than they have ever been handled before!

RADIO CORPORATION OF AMERICA
RCA Victor Division, Camden, N. J.

RCA TUBES FOR INDUSTRIAL EFFICIENCY

High-vacuum, gas, and vapor tubes . . . voltage amplifiers . . . low-power and medium-power tubes . . . cathode-ray tubes . . . phototubes . . . rectifiers . . . voltage regulators . . . relay tubes